

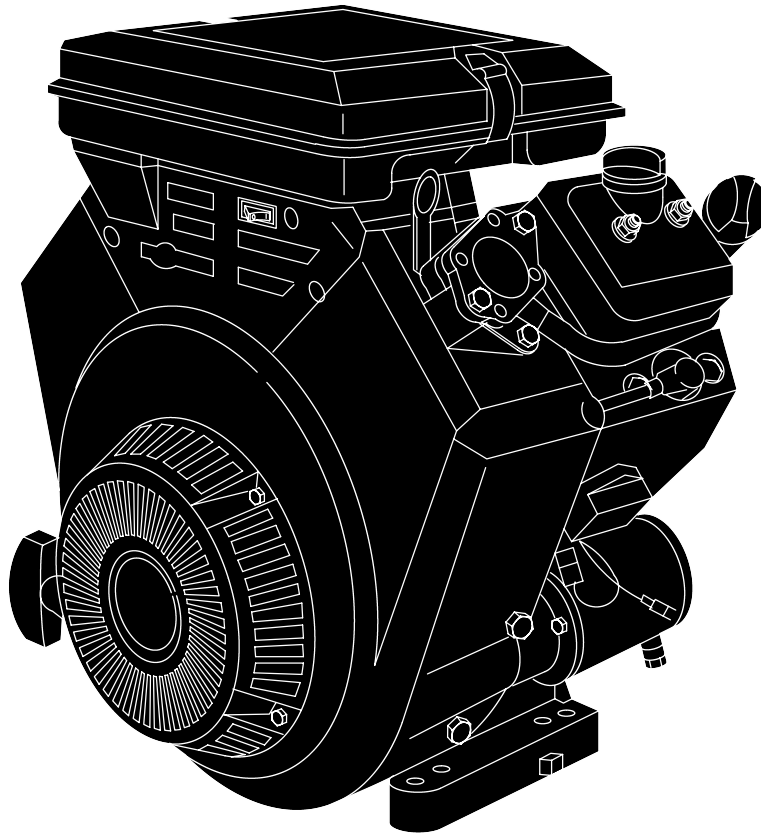

290000, 300000, 350000, 380000

- ⓐ *Operating & Maintenance Instructions*
- ⓑ *Instrucciones de Mantenimiento & Operación*
- ⓒ *Instructions d'utilisation et de maintenance*

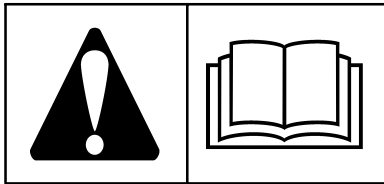

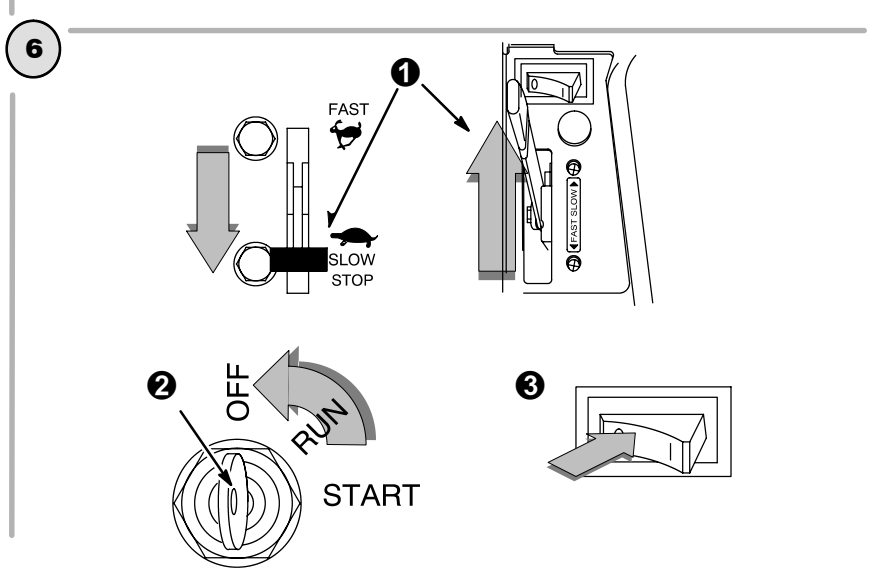
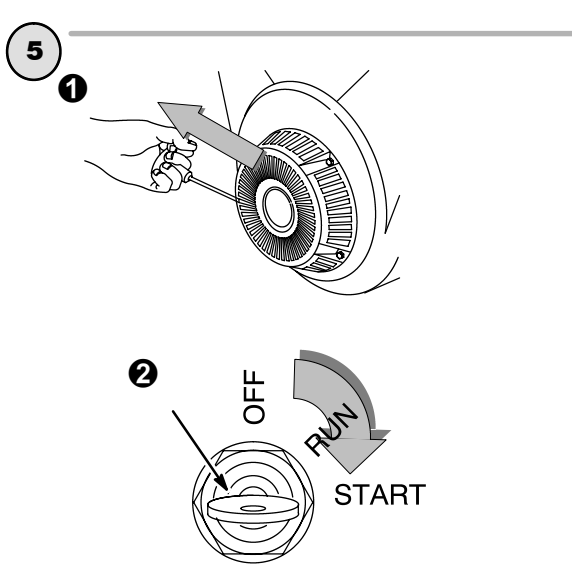
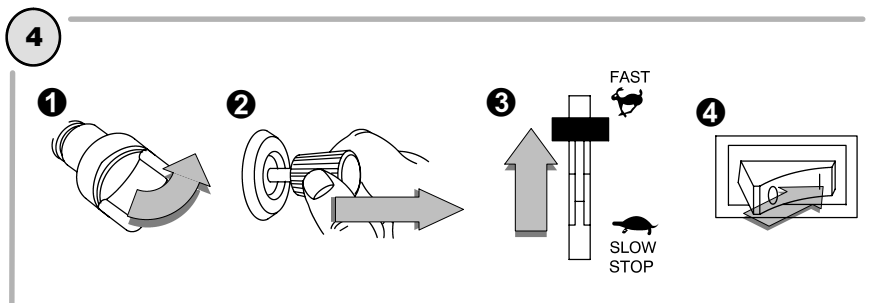
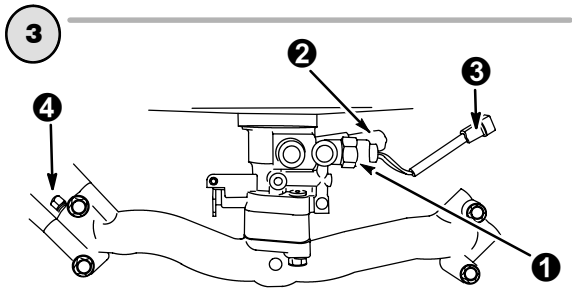
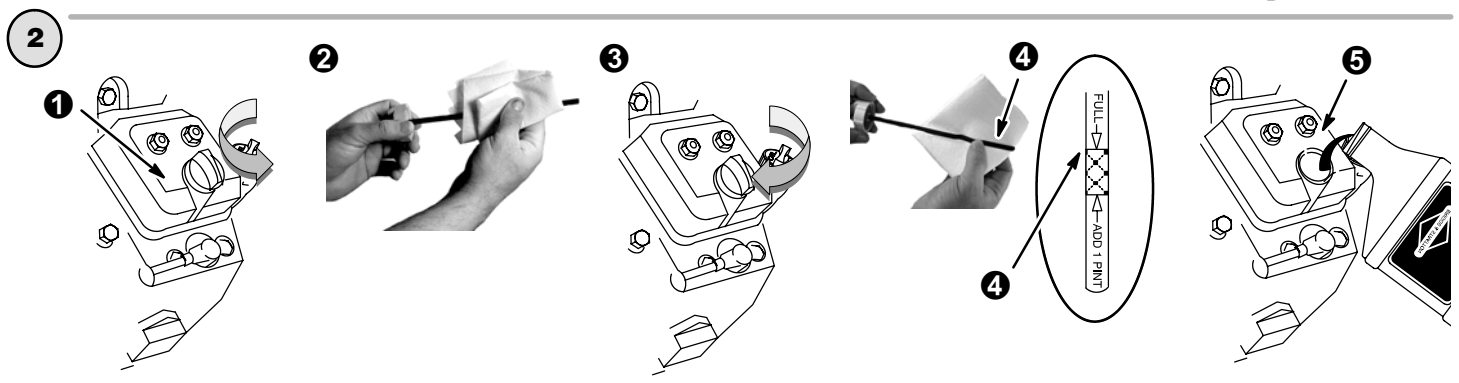
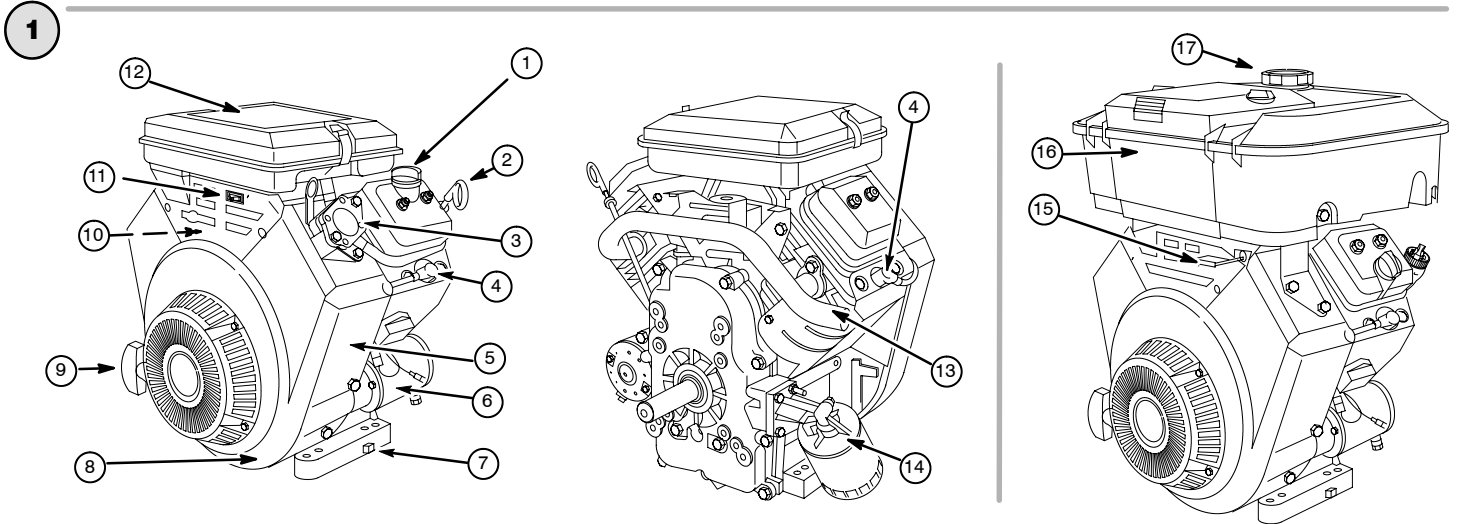

Note: (This note applies only to engines used in the U.S.A.) Maintenance, replacement or repair of the emission control devices and systems may be performed by any nonroad engine repair establishment or individual. However, to obtain no charge repairs under the terms and provisions of the Briggs & Stratton warranty statement, any service or emission control part repair or replacement must be performed by a factory authorized dealer.



WHEN USING THIS MANUAL, FIGURES REFERENCED IN THE TEXT ARE FOUND ON THE INSIDE FRONT AND INSIDE BACK COVERS.

## SYMBOLS ASSOCIATED WITH THIS ENGINE

### ENGINE FEATURES - SEE FIGURE 1

- ① Oil Fill Cap
- ② Dipstick
- ③ Fuel Pump (if equipped)
- ④ Spark Plug
- ⑤ Engine Model / Type / Code number  
XXXXXX XXXX-XX XXXXXXXX
- ⑥ 12 V Electric Starter (if equipped)
- ⑦ Oil Drain Plug
- ⑧ Blower Housing
- ⑨ Rope Handle
- ⑩ Carburetor or Liquid Petroleum Gas (LPG) / Natural Gas (NG) Fuel Mixer
- ⑪ Stop Switch (if equipped)
- ⑫ Air Cleaner (without fuel tank)
- ⑬ Exhaust manifold
- ⑭ Oil filter (if equipped)
- ⑮ Fuel Shut-Off Valve
- ⑯ Air Cleaner (with fuel tank)
- ⑰ Fuel fill/fuel tank (if equipped)

Record your engine Model, Type and Code numbers here for future use.



Record your date of purchase here for future use.





















### GENERAL INFORMATION



In the state of California, OHV Model Series 290000, 300000 and 350000 engines are certified by the California Air Resources Board to meet emissions standards for 250 hours. Such certification does not grant the purchaser, owner or operator of this engine any additional warranties with respect to the performance or operational life of this engine. This engine is warranted solely according to the product and emissions warranties stated elsewhere in this manual.

### SAFETY SPECIFICATIONS

A signal word (DANGER, WARNING, or CAUTION) is used with the alert symbol to indicate the likelihood and the potential severity of injury. In addition, a hazard symbol may be used to represent the type of hazard.

-  **DANGER** indicates a hazard which, if not avoided, **will result in death or serious injury.**
-  **WARNING** indicates a hazard which, if not avoided, **could result in death or serious injury.**
-  **CAUTION** indicates a hazard which, if not avoided, **might result in minor or moderate injury.**
- CAUTION**, when used **without** the alert symbol, indicates a situation that **could result in damage to the engine.**



	Safety Alert		Read Operator's Manual
	Fire		Shock
	Explosion		Hot Surface
	Kickback		Moving Parts
	Toxic Fumes		Wear Eye Protection
	Frostbite		
	On Off		Stop
	Oil		Slow
	Fuel		Fast
	Fuel Shutoff		Open Choke
			Full / Closed Choke



  This manual contains safety information to make you aware of the hazards and risks associated with engines, and how to avoid them. Because Briggs & Stratton does not necessarily know what equipment this engine will power, it is important that you read and understand these instructions and the instructions for the equipment this engine powers.



**WARNING**  
The engine exhaust from this product contains chemicals known to the State of California to cause cancer, birth defects, or other reproductive harm.



**WARNING**  
Briggs & Stratton does not approve or authorize the use of these engines on 3-wheel All Terrain Vehicles (ATVs), motor bikes, fun/recreational go-karts, aircraft products or vehicles intended for use in competitive events. Use of these engines in such applications could result in property damage, serious injury (including paralysis), or even death.

# SAFETY



 	 <b>WARNING</b> <b>Gasoline and its vapors are extremely flammable and explosive.</b> <b>Fire or explosion can cause severe burns or death.</b>
<b>WHEN ADDING FUEL</b> <ul style="list-style-type: none"><li>• Turn engine OFF and let engine cool at least 2 minutes before removing gas cap.</li><li>• Fill fuel tank outdoors or in well-ventilated area.</li><li>• On GASOLINE operated engines do not overfill fuel tank.</li><li>• Keep gasoline away from sparks, open flames, pilot lights, heat, and other ignition sources.</li><li>• Check fuel lines, tank, cap, and fittings frequently for cracks or leaks. Replace if necessary.</li></ul>	
<b>WHEN STARTING ENGINE</b> <ul style="list-style-type: none"><li>• Make sure spark plug, muffler, fuel cap and air cleaner are in place.</li><li>• Do not crank engine with spark plug removed.</li><li>• If fuel spills, wait until it evaporates before starting engine.</li><li>• If GASOLINE engine floods, set choke to OPEN/RUN position, place throttle in FAST and crank until engine starts.</li></ul>	
<b>WHEN OPERATING EQUIPMENT WITH GASOLINE ENGINE</b> <ul style="list-style-type: none"><li>• Do not tip engine or equipment at angle which causes gasoline to spill.</li><li>• Do not choke carburetor to stop engine.</li></ul>	
<b>WHEN TRANSPORTING EQUIPMENT</b> <ul style="list-style-type: none"><li>• <b>Gasoline Engine:</b> Transport with fuel tank EMPTY or with fuel shut-off valve OFF.</li><li>• <b>LIQUID PETROLEUM GAS (LPG) / NATURAL GAS (NG) ENGINE:</b> Transport with fuel cylinder EMPTY and valve closed or tank disconnected.</li></ul>	
<b>WHEN STORING FUEL OR EQUIPMENT WITH FUEL IN TANK OR IN FUEL CYLINDER</b> <ul style="list-style-type: none"><li>• Store away from furnaces, stoves, water heaters or other appliances that have pilot light or other ignition source because they can ignite gasoline vapors.</li></ul>	

 	 <b>WARNING</b> <b>Gaseous fuels are extremely flammable and readily form explosive air-vapor mixtures at ambient temperatures.</b>
<b>IF YOU SMELL GAS:</b> <ul style="list-style-type: none"><li>• DO NOT start the engine.</li><li>• DO NOT actuate any electrical switches.</li><li>• DO NOT use the phone in the vicinity.</li><li>• Evacuate the area.</li><li>• Contact the gas supplier or fire department.</li></ul>	
<b>REMEMBER:</b> <ul style="list-style-type: none"><li>• LPG vapor is heavier than air and tends to collect in low areas. NG vapor is lighter than air and tends to collect in high areas. Both may travel to remote locations.</li><li>• Keep all flames, sparks, pilot lights, and other ignition sources away from the area where the engine is operated or repaired.</li><li>• DO NOT smoke when operating or repairing the engine.</li><li>• DO NOT store gasoline or other flammable vapors or liquids in the vicinity of the engine.</li><li>• BEFORE doing any service work to the engine, shut off the gas supply.</li><li>• After initial installation or servicing, check for gas leaks. DO NOT use an open flame. Apply very soapy water or leak test solution with a brush and look for bubbles.</li><li>• Keep the equipment and the area surrounding the engine free of debris.</li><li>• Install the fuel system according to applicable fuel/gas codes.</li></ul>	

	 <b>WARNING</b> <b>Engines give off carbon monoxide, an odorless, colorless, poison gas.</b> <b>Breathing carbon monoxide can cause nausea, fainting or death.</b>
<ul style="list-style-type: none"><li>• Start and run engine outdoors.</li><li>• Do not start or run engine in enclosed area, even if doors or windows are open.</li></ul>	

 	 <b>WARNING</b> <b>Starting engine creates sparking.</b> <b>Sparking can ignite nearby flammable gases.</b> <b>Explosion and fire could result.</b>
<ul style="list-style-type: none"><li>• If there is natural or LP gas leakage in area, do not start engine.</li><li>• Do not use pressurized starting fluids because vapors are flammable.</li></ul>	

	 <b>WARNING</b> <b>Rotating parts can contact or entangle hands, feet, hair, clothing, or accessories.</b> <b>Traumatic amputation or severe laceration can result.</b>
<ul style="list-style-type: none"><li>• Operate equipment with guards in place.</li><li>• Keep hands and feet away from rotating parts.</li><li>• Tie up long hair and remove jewelry.</li><li>• Do not wear loose-fitting clothing, dangling drawstrings or items that could become caught.</li></ul>	

	 <b>WARNING</b> <b>Rapid retraction of starter cord (kickback) will pull hand and arm toward engine faster than you can let go.</b> <b>Broken bones, fractures, bruises or sprains could result.</b>
<ul style="list-style-type: none"><li>• When starting engine, pull cord slowly until resistance is felt, then pull rapidly.</li><li>• Remove all external equipment/engine loads before starting engine.</li><li>• Direct coupled equipment components such as, but not limited to, blades, impellers, pulleys, sprockets, etc., must be securely attached.</li></ul>	

 	 <b>WARNING</b> <b>Running engines produce heat. Engine parts, especially muffler, become extremely hot.</b> <b>Severe thermal burns can occur on contact.</b> <b>Combustible debris, such as leaves, grass, brush, etc. can catch fire.</b>
<ul style="list-style-type: none"><li>• Allow muffler, engine cylinder and fins to cool before touching.</li><li>• Remove accumulated combustibles from muffler area and cylinder area.</li><li>• Install and maintain in working order a spark arrester before using equipment on forest-covered, grass-covered, brush-covered unimproved land. The state of California requires this (Section 4442 of the California Public Resources Code). Other states may have similar laws. Federal laws apply on federal land.</li></ul>	

	 <b>WARNING</b> <b>Wear eye protection when doing repair work.</b> <b>Frostbite can result from skin/eye contact with leaking LP liquid.</b>
<ul style="list-style-type: none"><li>• Installation, adjustment and repair work should be done by a qualified technician.</li><li>• Flexible supply lines should be checked regularly to make sure they are in good condition. Replace damaged or leaking components.</li></ul>	

**WARNING**

**Unintentional sparking can result in fire or electric shock.**

**Unintentional start-up can result in entanglement, traumatic amputation, or laceration.**

**BEFORE PERFORMING ADJUSTMENTS OR REPAIRS**

- Disconnect spark plug wires and keep them away from spark plugs.

**WHEN TESTING FOR SPARK**

- Use approved spark plug tester.
- Do not check for spark with spark plugs removed.

## OIL RECOMMENDATIONS

Use a high quality detergent oil classified "For Service SF, SG, SH, SJ" or higher. Do not use special additives.

**SAE 30 40 F and higher (5 °C and higher)**

is good for all purpose use above 40°F, use below 40°F will cause hard starting.

**10W-30 0 to 100 F (-18 to 38 °C)**

is better for varying temperature conditions. This grade of oil improves cold weather starting, but may increase oil consumption at 80°F (27°C) or higher.

★ Check oil level frequently at higher temperatures.

**Synthetic 5W-30 -20 to 120 F (-30 to 40 °C)**

provides the best protection at all temperatures as well as improved starting with less oil consumption.

**5W-30 40 F and below (5 °C and below)**

is recommended for winter use, and works best in cold conditions.

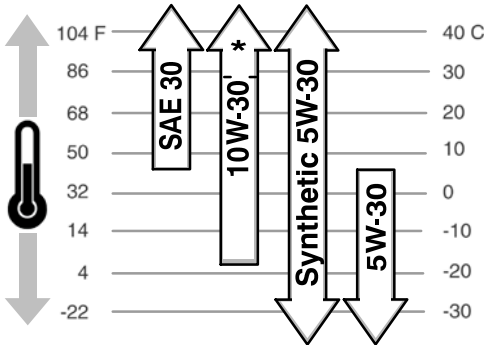

## OIL CAPACITY

Approximately 1-1/2 quarts (48 ounces or 1.6 liters) when changing oil and filter. (Oil capacity will be greater if engine is equipped with remote oil filter.)

**CAUTION:** Engine is shipped from Briggs & Stratton without oil. Before starting engine, fill to FULL mark on dipstick with oil. **Do not over fill.**

## ADDING OIL - SEE FIGURE 2

1. For first use or when performing oil change, add 1 liter (32 ounces). ⑤
2. Start and run engine at idle for 30 seconds. Shut engine off and wait 30 seconds.
3. Then add more oil slowly to bring level to FULL mark ④ on dipstick. Check for oil leaks.
4. Tighten dipstick firmly before starting engine.

## CHECKING OIL

1. Place engine on level surface and clean around oil fill ①.
2. Remove dipstick ②, wipe with clean cloth. Insert dipstick firmly ③, then remove and check oil level.
3. Oil should be at FULL mark ④. If oil is required, add oil slowly. ⑤
4. Tighten dipstick firmly before starting engine.

## OIL PRESSURE

If engine runs low on oil, an **oil pressure switch** (if engine is equipped) will either activate a warning device or stop the engine. (Read the operating instructions supplied by the equipment manufacturer to determine which way your engine is equipped.) See Maintenance for further information.

## FUEL RECOMMENDATIONS

### GASOLINE POWERED ENGINES

This engine is certified to operate on gasoline. The emission control system for this engine is EM (Engine Modifications).

**Always** use gasoline that meets these requirements and follow these guidelines:

- Clean, fresh unleaded gasoline.
- A minimum of 87 octane/87 AKI (91 RON). If operating at high altitude, see below.
- Gasoline with up to 10% ethanol (gasohol) or up to 15% MTBE (methyl tertiary butyl ether), is acceptable.
- Use of any gasoline other than those approved above will void the engine warranty. In some local areas fuel pumps may be marked if the gasoline contains alcohols or ethers. If you are unsure about the gasoline you purchase check with your fuel provider.
- Do not modify the engine fuel system or carburetor to run on alternative fuels.
- Never mix oil with gasoline.

All gasoline is not the same. If you experience starting or performance problems after new gasoline has been used in your engine, switch to a different fuel provider or change fuel brands.

**CAUTION:** Some fuels, called oxygenated or reformulated fuels, are fuels blended with alcohols or ethers. Excessive amounts of these blends can damage the fuel system or cause performance problems. If any undesirable operating symptoms occur, use gasoline with a lower percentage of alcohol or ether.

### FUEL STABILIZER

To protect the fuel system from gum formation, mix in a fuel preservative when adding fuel. Briggs & Stratton recommends using FRESH START™ fuel stabilizer, available as a liquid additive, concentrated liquid cartridge or granular additive.

### HIGH ALTITUDE USE

At higher altitudes (over 5,000 feet), 85 octane/85 AKI (89 RON) gasoline can be used. Operation at high altitude may require a high-altitude carburetor jet kit to improve performance and decrease fuel consumption. See an Authorized Briggs & Stratton dealer for more information.

### ADDING GASOLINE

Clean around fuel fill before removing cap. Remove cap. Fill tank to approximately 1-1/2 inches below top of neck to allow for fuel expansion. Be careful not to overfill.

### LIQUID PROPANE GAS (LPG)

### NATURAL GAS (NG) POWERED ENGINES

- Use clean, dry fuel, free of moisture or any particulate material. Using fuels outside the following recommended values may cause performance problems.
- In engines set up to run on LPG, commercial grade HD5 LPG is recommended. Recommended fuel composition is fuel with a minimum fuel energy of 2500 BTU's/ft<sup>3</sup> with maximum propylene content of 5% and butane and heavier gas content of 2.5% and minimum propane content of 90%.
- LPG or NG engines are certified to operate on liquid propane or natural gas.

### ADDING FUEL

Read the operating instructions supplied by the equipment manufacturer for information on refueling LPG or NG engine.

**WARNING**

**LPG/NG Engines:** The equipment on which this engine is mounted is equipped with an automatic safety gas "fuel lock-off" valve. **DO NOT** operate the equipment if the "fuel lock-off" valve is missing or inoperative, explosion or fire could occur.

## STARTING

**CAUTION:** This engine is shipped from Briggs & Stratton WITHOUT oil. Check oil level. If you start the engine without oil, the engine will be damaged beyond repair and will not be covered under warranty. See Oil section for recommendations, capacity and filling details.

### BEFORE STARTING LPG / NG ENGINES - SEE FIGURE 3

The LPG / NG mixer is equipped with solenoid ❶, fuel inlet ❷, 12 volt connector ❸, and equipped for a fuel lock-off valve ❹. (Read the operating instructions supplied by the equipment manufacturer to determine how your engine is equipped.)

### BEFORE STARTING ALL ENGINES - SEE FIGURE 4

Note: LPG / NG engines skip steps 1 and 2.

Note: If equipment manufacturer has supplied battery, charge it as manufacturer recommends before trying to start engine.

1. Open fuel shut-off valve ❶ (if equipped).
2. Move choke control ❷ to CHOKE or START.
3. Move throttle (if equipped) ❸ to FAST position. (Operate engine with throttle in FAST position and choke in RUN or OFF position.)
4. Push rocker switch ❹ to I position, if equipped.

### REWIND STARTER - SEE FIGURE 5

1. Grasp rope handle and pull slowly until resistance is felt.
2. Then, pull cord rapidly to overcome compression, prevent kickback and start engine.
3. Repeat if necessary with choke in RUN position throttle in FAST.
4. When engine starts, operate in FAST.

### ELECTRIC STARTER - SEE FIGURE 5

**CAUTION:** If equipment manufacturer has supplied battery, charge it before trying to start engine. DO NOT operate engine with battery disconnected. To prolong starter life, use short starting cycles (5 seconds maximum, then wait one minute). Extended cranking can damage starter motor.

1. Turn key to START position ❶ or press button ❷.
2. Repeat if necessary with choke off and throttle control in FAST position.
3. Allow engine to warm up.
4. **If choke equipped:** Slowly adjust toward RUN or OFF position. Wait until engine runs smoothly before each choke adjustment.
5. Operate engine with choke off and throttle in FAST position.

### STOPPING - SEE FIGURE 6

1. **Rewind (Manual) Starter:** Move throttle control (if equipped) to SLOW and then STOP ❶ position.
2. **Electric (Key) Starter:** Move throttle lever (if equipped) to SLOW. Turn key to OFF ❷. Remove key and store out of reach of children.
3. Push rocker switch (if equipped) to O ❸.
4. Close fuel shut-off valve (if equipped).

### WARNING

DO NOT move choke control to CHOKE position to stop engine. Backfire or engine damage may occur.

## MAINTENANCE

### WARNING

To prevent accidental starting, disconnect spark plug wire and keep it away from spark plug before servicing.

Do not strike flywheel with hammer or hard object. If done, flywheel may shatter during operation.

Do not tamper with links or other parts to increase engine speed.

Regular maintenance improves performance and extends engine life.

**Need assistance? Go to [www.briggsandstratton.com](http://www.briggsandstratton.com).**

Follow the hourly or calendar intervals, whichever occur first. More frequent service is required when operating in adverse conditions noted below.

#### First 8 Hours

- Change oil

#### Every 8 Hours or Daily

- Check oil level
- Clean around muffler, linkage and springs

#### Every 25 Hours or Every Season

- Change oil if operating under heavy load or high ambient temperature
- Service air cleaner pre-cleaner \*

#### Every 50 Hours or Every Season

- Clean and inspect spark arrester, if equipped

#### Every 100 Hours or Every Season

- Service air cleaner cartridge\*
- Change oil
- Replace oil filter, if equipped
- Clean oil cooler, if equipped\*
- Clean cooling system\*
- Check valve clearance - LPG / NG engines

#### Every Season

- Replace spark plugs\*\*
- Replace in-line fuel filter
- Check valve clearance

\* Clean more often under dusty conditions or when airborne debris is present.

\*\* In some areas, local law requires using a resistor spark plug to suppress ignition signals. If this engine was originally equipped with resistor spark plug, use same type of spark plug for replacement.

## CHANGING ENGINE OIL - SEE FIGURE 7

Change oil after first 8 hours of operation.

1. Change oil while engine is warm.
2. Remove oil drain plug to drain oil. ❶
3. Refill with new oil of recommended SAE viscosity grade.
4. Fill to FULL mark on dipstick.

### OIL FILTER ❷, IF EQUIPPED.

Replace oil filter after every 100 hours of operation or every season, whichever occurs first.

1. Before installing new filter, lightly oil filter gasket with fresh, clean engine oil.
2. Screw filter on by hand until gasket contacts oil filter adapter. Tighten 1/2 to 3/4 turn more.
3. Refill engine with new oil of recommended SAE viscosity grade. See *Adding Oil* under **OIL RECOMMENDATIONS** for procedure.
4. Start and run engine at IDLE to check for oil leaks.
5. Stop engine. Recheck oil level and add oil if required.

### OIL PRESSURE

If oil pressure drops below 1-4 psi (.1-.2 kg/cm<sup>2</sup>), an oil pressure switch (if engine is equipped) will either activate a warning device or stop the engine. Check oil level with dipstick. If oil level is between **ADD** and **FULL** mark on dipstick, do not try to restart engine. Contact an Authorized Briggs & Stratton Service Dealer. Do not operate engine until oil pressure is corrected.

If oil level is below **ADD** mark on dipstick, add oil to bring level to **FULL** mark. Restart engine and check oil pressure. If pressure is normal, continue to operate engine.

**Note:** Oil pressure gauge, if engine is equipped, is supplied by manufacturer of equipment.

## AIR CLEANER, DUAL ELEMENT - SEE FIGURE 8

1. Unhook clips or unscrew knobs and remove cover.
2. Carefully slide pre-cleaner ❶ off cartridge ❷.
3. Remove knob and plate. Carefully remove cartridge to prevent debris from entering carburetor.

To service cartridge, clean by tapping gently on a flat surface. Replace pre-cleaner, if equipped, or cartridge if very dirty or damaged.

**CAUTION:** Do not use petroleum solvents, e.g., kerosene, which will cause cartridge to deteriorate. Do not use pressurized air, which can damage cartridge. Do not oil cartridge.

4. Reinstall cartridge, plate and knob.

**Note:** Top of air cleaner plate ❸ is marked "UP" (only on engines equipped with fuel tank).

5. Install pre-cleaner on cartridge and replace cover.

## SPARK PLUG SERVICE - SEE FIGURE 9



**WARNING**

DO NOT check for spark with spark plug removed.

Use only Briggs & Stratton Spark Tester, to check for spark.

- If engine is flooded, place throttle in FAST and crank until engine starts.
- The electrodes on the spark plug must be clean and sharp to produce the powerful spark required for ignition. If the spark plug is worn or dirty the engine will be hard to start.
- Ensure spark plug gap ❶ is 0.76 mm or 0.030 in.

**Note:** In some areas, local law requires using a resistor spark plug to suppress ignition signals. If this engine was originally equipped with resistor spark plug, use same type of spark plug for replacement.

## MUFFLER - SEE FIGURE 10



**WARNING**

Accumulation of debris around muffler ❶ could cause a fire. Inspect and clean before every use.

If muffler is equipped with spark arrester screen ❷, remove spark arrester screen for cleaning and inspection every 50 hours or every season. Replace if damaged.

## FUEL FILTER

Replace in-line fuel filter ❸ every season. Drain fuel tank or close fuel shut-off valve before replacing fuel filter.

## KEEP ENGINE CLEAN - SEE FIGURE 11

Periodically, after engine cools, remove debris from engine to reduce risk of overheating and ignition. Clean finger guard. Keep linkage, springs and controls ❶ free of debris.

**CAUTION:** Clean with a brush or compressed air. DO NOT use water to clean engine parts. Water could contaminate fuel system. Use a brush or dry cloth.

### OIL COOLER

Clean oil cooler ❹ every 100 hours or every season, if equipped.

### COOLING SYSTEM

Debris may clog engine's air cooling system, especially after prolonged service. Every 100 hours or every season, clean internal cooling fins ❺ and surfaces to prevent overheating and engine damage. Remove blower housing to clean areas shown.

## VALVE CLEARANCE

### Gasoline Engines -

Check valve clearance yearly (intake and exhaust .10-.15 mm).

### LPG / NG Engines -

Valve clearance must be checked after every 100 hours of operation. Adjust if necessary.

## SPECIFICATIONS

### Model Series 290000 & 300000

Bore	68 mm (2.68 in.)
Stroke	66 mm (2.60 in.)
Displacement	480 cc (29.3 cu. in.)

### Model Series 350000

Bore	72 mm (2.83 in.)
Stroke	70 mm (2.76 in.)
Displacement	570 cc (34.7 cu. in.)

### Model Series 380000

Bore	76 mm (2.97 in.)
Stroke	70 mm (2.76 in.)
Displacement	627 cc (38.2 cu. in.)

**Armature air gap** . . . . . 0.20-0.30 mm (0.008-0.012 in.)

**Spark plug gap** . . . . . 0.76 mm (0.030 in.)

**Valve clearance** with valve springs installed and piston 6 mm past top dead center (check when engine is cold). See Repair Manual P/N 272144.

Intake . . . . . 0.10-0.15 mm (0.004-0.006 in.)

Exhaust . . . . . 0.10-0.15 mm (0.004-0.006 in.)

**Note:** Engine power will decrease 3-1/2% for each 1,000 feet (300 meters) above sea level and 1% for each 10° F (5.6° C) above 77° F (25° C). It will operate satisfactorily at an angle up to 15°. Refer to the equipment operator manual for safe allowable operating limits on slopes.

## STORAGE

Engines stored over 30 days need to be protected or drained of fuel to prevent gum from forming in fuel system or on essential carburetor parts.

For engine protection, we recommend use of Briggs & Stratton Fuel Stabilizer available from an Authorized Briggs & Stratton Service Dealer. Mix stabilizer with fuel in fuel tank or storage container. Run engine for a short time to circulate stabilizer through carburetor. Engine and fuel can be stored up to 24 months.

**Note:** If stabilizer is not used or if engine is operating on gasoline containing alcohol, e.g. gasohol, remove all fuel from tank and run engine until it stops from lack of fuel.

1. Change oil. See **Oil service**.
2. Remove spark plug and pour about 30 ml (1 oz) of engine oil into cylinder. Replace spark plug and crank slowly to distribute oil.
3. Clean chaff and debris from cylinder and cylinder head fins, under finger guard and behind muffler.
4. When removing the unit from storage, only use fresh gasoline. Perform operation checks, see maintenance schedule, before starting engine.

## SERVICE

See an Authorized Briggs & Stratton Service Dealer. Each one carries a stock of Genuine Briggs & Stratton Parts and is equipped with special service tools. Trained mechanics assure expert repair service on all Briggs & Stratton engines. Only dealers advertising as "Authorized Briggs & Stratton" are required to meet Briggs & Stratton standards.

When you purchase equipment powered by a Briggs & Stratton engine, you are assured of highly skilled, reliable service at more than 30,000 Authorized Service Dealers worldwide, including more than 6,000 Master Service Technicians. Look for these signs wherever Briggs & Stratton service is offered.



### Partial List of Genuine Briggs & Stratton Parts

Part	Part No.
Oil (48 oz.)	100028
Oil filter (6 cm long)	492932
Oil filter (9 cm long)	491056
Oil pump kit (uses electric drill to remove oil from engine)	5056
Fuel stabilizer (4.2 oz., 125 ml bottle)	5041
Fuel filter (without fuel pump)	298090
Fuel filter (with fuel pump)	691035
Fuel filter (with 9 qt. fuel tank on engine)	808116
Air cleaner cartridge (with 9 qt. fuel tank on engine)	393957
Air cleaner pre-cleaner (with 9 qt. fuel tank on engine)	271794
Air cleaner cartridge (all other models except model 380000)	394018
Air cleaner pre-cleaner (all other models except model 380000)	272490
Air cleaner cartridge (model 380000)	692519
Air cleaner pre-cleaner (model 380000)	692520
Resistor spark plug	491055 or 496018
Long life platinum spark plug (used on most OHV engines)	5066
Spark tester	19368

You may find the nearest Authorized Service Dealer in our dealer locator map at [www.briggsandstratton.com](http://www.briggsandstratton.com) or by calling 1-800-233-3723.



**Briggs & Stratton Corporation (B&S),  
the California Air Resources Board (CARB)  
and the United States  
Environmental Protection Agency (U.S. EPA)  
Emissions Control System Warranty Statement  
(Owner's Defect Warranty Rights and Obligations)**

**California, United States and Canada Emissions  
Control Defects Warranty Statement**

The California Air Resources Board (CARB), U.S. EPA and B&S are pleased to explain the emissions Control System Warranty on your small off-road engine (SORE). In California, new small off-road engines model year 2006 and later must be designed, built and equipped to meet the State's stringent anti-smog standards. Elsewhere in the United States, new non-road, spark-ignition engines certified for model year 1997 and later must meet similar standards set forth by the U.S. EPA. B&S must warrant the emissions control system on your engine for the periods of time listed below, provided there has been no abuse, neglect or improper maintenance of your small off-road engine.

Your emissions control system includes parts such as the carburetor, air cleaner, ignition system, fuel line, muffler and catalytic converter. Also included may be connectors and other emissions related assemblies.

Where a warrantable condition exists, B&S will repair your small off-road engine at no cost to you including diagnosis, parts and labor.

**Briggs & Stratton Emissions Control  
Defects Warranty Coverage**

Small off-road engines are warranted relative to emissions control parts defects for a period of two years, subject to provisions set forth below. If any covered part on your engine is defective, the part will be repaired or replaced by B&S.

**Owner's Warranty Responsibilities**

As the small off-road engine owner, you are responsible for the performance of the required maintenance listed in your Operating and Maintenance Instructions. B&S recommends that you retain all your receipts covering maintenance on your small off-road engine, but B&S cannot deny warranty solely for the lack of receipts or for your failure to ensure the performance of all scheduled maintenance.

As the small off-road engine owner, you should however be aware that B&S may deny you warranty coverage if your small off-road engine or a part has failed due to abuse, neglect, improper maintenance or unapproved modifications.

You are responsible for presenting your small off-road engine to an Authorized B&S Service Dealer as soon as a problem exists. The undisputed warranty repairs should be completed in a reasonable amount of time, not to exceed 30 days.

If you have any questions regarding your warranty rights and responsibilities, you should contact a B&S Service Representative at 1-414-259-5262.

The emissions warranty is a defects warranty. Defects are judged on normal engine performance. The warranty is not related to an in-use emissions test.

**Briggs & Stratton Emissions Control  
Defects Warranty Provisions**

The following are specific provisions relative to your Emissions Control Defects Warranty Coverage. It is in addition to the B&S engine warranty for non-regulated engines found in the Operating and Maintenance Instructions.

1. **Warranted Parts**  
Coverage under this warranty extends only to the parts listed below (the emissions control systems parts) to the extent these parts were present on the engine purchased.
  - a. **Fuel Metering System**
    - Cold start enrichment system (soft choke)
    - Carburetor and internal parts
    - Fuel Pump
    - Fuel line, fuel line fittings, clamps
  - b. **Air Induction System**
    - Air cleaner
    - Intake manifold
  - c. **Ignition System**
    - Spark plug(s)
    - Magneto ignition system
  - d. **Catalyst System**
    - Catalytic converter
    - Exhaust manifold
    - Air injection system or pulse valve
  - e. **Miscellaneous Items Used in Above Systems**
    - Vacuum, temperature, position, time sensitive valves and switches
    - Connectors and assemblies
2. **Length of Coverage**  
B&S warrants to the initial owner and each subsequent purchaser that the Warranted Parts shall be free from defects in materials and workmanship which caused the failure of the Warranted Parts for a period of two years from the date the engine is delivered to a retail purchaser.
3. **No Charge**  
Repair or replacement of any Warranted Part will be performed at no charge to the owner, including diagnostic labor which leads to the determination that a Warranted Part is defective, if the diagnostic work is performed at an Authorized B&S Service Dealer. For emissions warranty service contact your nearest Authorized B&S Service Dealer as listed in the "Yellow Pages" under "Engines, Gasoline," "Gasoline Engines," "Lawn Mowers," or similar category.
4. **Claims and Coverage Exclusions**  
Warranty claims shall be filed in accordance with the provisions of the B&S Engine Warranty Policy. Warranty coverage shall be excluded for failures of Warranted Parts which are not original B&S parts or because of abuse, neglect or improper maintenance as set forth in the B&S Engine Warranty Policy. B&S is not liable to cover failures of Warranted Parts caused by the use of add-on, non-original, or modified parts.
5. **Maintenance**  
Any Warranted Part which is not scheduled for replacement as required maintenance or which is scheduled only for regular inspection to the effect of "repair or replace as necessary" shall be warranted as to defects for the warranty period. Any Warranted Part which is scheduled for replacement as required maintenance shall be warranted as to defects only for the period of time up to the first scheduled replacement for that part. Any replacement part that is equivalent in performance and durability may be used in the performance of any maintenance or repairs. The owner is responsible for the performance of all required maintenance, as defined in the B&S Operating and Maintenance Instructions.
6. **Consequential Coverage**  
Coverage hereunder shall extend to the failure of any engine components caused by the failure of any Warranted Part still under warranty.

**Look For Relevant Emission  
Durability Period and  
Air Index Information On  
Your Engine Emission Label**

Engines that are certified to meet the California Air Resources Board (CARB) Tier 2 Emission Standards must display information regarding the Emissions Durability Period and the Air Index. Briggs & Stratton makes this information available to the consumer on our emission labels. The engine emission label will indicate certification information.

The **Emissions Durability Period** describes the number of hours of actual running time for which the engine is certified to be emissions compliant, assuming proper maintenance in accordance with the Operating & Maintenance Instructions. The following categories are used:

**Moderate:**  
Engine is certified to be emission compliant for 125 hours of actual engine running time.

**Intermediate:**  
Engine is certified to be emission compliant for 250 hours of actual engine running time.

**Extended:**  
Engine is certified to be emission compliant for 500 hours of actual engine running time. For example, a typical walk-behind lawn mower is used 20 to 25 hours per year. Therefore, the **Emissions Durability Period** of an engine with an **intermediate** rating would equate to 10 to 12 years.

Certain Briggs & Stratton engines will be certified to meet the United States Environmental Protection Agency (USEPA) Phase 2 emission standards. For Phase 2 certified engines, the Emissions Compliance Period referred to on the Emissions Compliance label indicates the number of operating hours for which the engine has been shown to meet Federal emission requirements.

For engines less than 225 cc displacement.  
Category C = 125 hours  
Category B = 250 hours  
Category A = 500 hours

For engines of 225 cc or more displacement.  
Category C = 250 hours  
Category B = 500 hours  
Category A = 1000 hours

Briggs & Stratton Engines Are Made Under One Or More Of The Following Patents: Design D-247,177 (Other Patents Pending)										
6,691,683	6,520,141	6,325,036	6,145,487	6,012,420	5,803,035	5,548,955	5,243,878	5,138,996	4,875,448	D 476,629
6,647,942	6,495,267	6,311,663	6,142,257	5,992,367	5,765,713	5,546,901	5,235,943	5,086,890	4,819,593	D 457,891
6,622,683	6,494,175	6,284,123	6,135,426	5,904,124	5,732,555	5,445,014	5,234,038	5,070,829	4,720,638	D 368,187
6,615,787	6,472,790	6,263,852	6,116,212	5,894,715	5,645,025	5,503,125	5,228,487	5,058,544	4,719,682	D 375,963
6,617,725	6,460,502	6,260,529	6,105,548	5,887,678	5,642,701	5,501,203	5,197,426	5,040,644	4,633,556	D 309,457
6,603,227	6,456,515	6,242,828	6,347,614	5,852,951	5,628,352	5,497,679	5,197,425	5,009,208	4,630,498	D 372,871
6,595,897	6,382,166	6,239,709	6,082,323	5,843,345	5,619,845	5,320,795	5,197,422	4,996,956	4,522,080	D 361,771
6,595,176	6,369,532	6,237,555	6,077,063	5,823,153	5,606,948	5,301,643	5,191,864	4,977,879	4,520,288	D 356,951
6,584,964	6,356,003	6,230,678	6,064,027	5,819,513	5,606,851	5,271,363	5,188,069	4,977,877	4,512,499	D 309,457
6,557,833	6,349,688	6,213,083	6,040,767	5,813,368	5,605,130	5,269,713	5,186,142	4,971,219	4,453,507	D 308,872
6,542,074	6,347,614	6,202,616	6,014,808	5,809,958	5,497,679	5,265,700	5,150,674	4,895,119	4,430,984	D 308,871

## BRIGGS & STRATTON ENGINE OWNER WARRANTY POLICY

Effective January 1, 2006 replaces all undated Warranties and all Warranties dated before January 1, 2006.

### LIMITED WARRANTY

Briggs & Stratton Corporation will repair or replace, free of charge, any part(s) of the engine that is defective in material or workmanship or both. Transportation charges on product submitted for repair or replacement under this warranty must be borne by purchaser. This warranty is effective for the time periods and subject to the conditions stated below. For warranty service, find the nearest Authorized Service Dealer in our dealer locator map at [www.briggsandstratton.com](http://www.briggsandstratton.com), or by calling 1-800-233-3723.

THERE IS NO OTHER EXPRESS WARRANTY, IMPLIED WARRANTIES, INCLUDING THOSE OF MERCHANTABILITY AND FITNESS FOR A PARTICULAR PURPOSE, ARE LIMITED TO ONE YEAR FROM PURCHASE, OR TO THE EXTENT PERMITTED BY LAW ANY AND ALL IMPLIED WARRANTIES ARE EXCLUDED. LIABILITY FOR INCIDENTAL OR CONSEQUENTIAL DAMAGES ARE EXCLUDED TO THE EXTENT EXCLUSION IS PERMITTED BY LAW. Some states or countries do not allow limitations on how long an implied warranty lasts, and some states or countries do not allow the exclusion or limitation of incidental or consequential damages, so the above limitation and exclusion may not apply to you. This warranty gives you specific legal rights and you may also have other rights which vary from state to state and country to country.

### WARRANTY TERMS\*\*

Brand / Product Type	Consumer Use	Commercial Use	Condition of Warranty Term
Classic™	1 year	90 days	2 years Consumer Use in European Union
Etek™	1 year	1 year	
Etended Life Series™	2 years	1 year	
Fource™	2 years	90 days	
I/C™	2 years	1 year	
Industrial Plus™	2 years	1 year	
Intek™ (Kool Bore)	2 years	90 days	
Intek™ (Sleeve Bore)	2 years	1 year	
Kerosene fuel operated engines	1 year	90 days	
Powerbuilt™ OHV	2 years	90 days	
Q45™	2 years	90 days	
Quantum®	2 years	90 days	
Quattro™	2 years	90 days	
Sprint™	2 years	90 days	
Vanguard™	2 years	2 years	
2-Cycle Snow engine	2 years	90 days	
Touch-N-Mow™ Starter	5 years	90 days	Equipped on Quantum® or Intek™ engines

\*\*Engines used on Home Standby Generator applications are warranted under consumer use only. This warranty does not apply to engines on equipment used for prime power in place of a utility. **Engines used in competitive racing or on commercial or rental tracks are not warrantied.**

The warranty period begins on the date of purchase by the first retail consumer or commercial end user, and continues for the period of time stated in the table above. "Consumer use" means personal residential household use by a retail consumer. "Commercial use" means all other uses, including use for commercial, income producing or rental purposes. Once an engine has experienced commercial use, it shall thereafter be considered as a commercial use engine for purposes of this warranty.

**NO WARRANTY REGISTRATION IS NECESSARY TO OBTAIN WARRANTY ON BRIGGS & STRATTON PRODUCTS. SAVE YOUR PROOF OF PURCHASE RECEIPT. IF YOU DO NOT PROVIDE PROOF OF THE INITIAL PURCHASE DATE AT THE TIME WARRANTY SERVICE IS REQUESTED, THE MANUFACTURING DATE OF THE PRODUCT WILL BE USED TO DETERMINE THE WARRANTY PERIOD.**

### ABOUT YOUR ENGINE WARRANTY

Briggs & Stratton welcomes warranty repair and apologizes to you for being inconvenienced. Any Authorized Service Dealer may perform warranty repairs. Most warranty repairs are handled routinely, but sometimes requests for warranty service may not be appropriate. For example, warranty would not apply if engine damage occurred because of misuse, lack of routine maintenance, shipping, handling, warehousing or improper installation. Similarly, warranty is void if the serial number of the engine has been removed or the engine has been altered or modified.

If a customer differs with the decision of the Service Dealer, an investigation will be made to determine whether the warranty applies. Ask the Service Dealer to submit all supporting facts to his Distributor or the Factory for review. If the Distributor or the Factory decides that the claim is justified, the customer will be fully reimbursed for those items that are defective. To avoid misunderstanding which might occur between the customer and the Dealer, listed below are some of the causes of engine failure that the warranty does not cover.

#### Normal wear:

Engines, like all mechanical devices, need periodic parts service and replacement to perform well. Warranty will not cover repair when normal use has exhausted the life of a part or an engine.

#### Improper maintenance:

The life of an engine depends upon the conditions under which it operates, and the care it receives. Some applications, such as tillers, pumps and rotary mowers, are very often used in dusty or dirty conditions, which can cause what appears to be premature wear. Such wear,

when caused by dirt, dust, spark plug cleaning grit, or other abrasive material that has entered the engine because of improper maintenance, is not covered by warranty.

**This warranty covers engine related defective material and/or workmanship only, and not replacement or refund of the equipment to which the engine may be mounted. Nor does the warranty extend to repairs required because of:**

1. PROBLEMS CAUSED BY PARTS THAT ARE NOT ORIGINAL BRIGGS & STRATTON PARTS.
2. Equipment controls or installations that prevent starting, cause unsatisfactory engine performance, or shorten engine life. (Contact equipment manufacturer.)
3. Leaking carburetors, clogged fuel pipes, sticking valves, or other damage, caused by using contaminated or stale fuel.
4. Parts which are scored or broken because an engine was operated with insufficient or contaminated lubricating oil, or an incorrect grade of lubricating oil (Check and refill when necessary, and change at recommended intervals.) OIL GARD® may not shut down running engine. Engine damage may occur if oil level is not properly maintained.
5. Repair or adjustment of associated parts or assemblies such as clutches, transmissions, remote controls, etc., which are not manufactured by Briggs & Stratton.
6. Damage or wear to parts caused by dirt, which entered the engine because of improper air cleaner maintenance, re-assembly, or use of a non-original

air cleaner element or cartridge. At recommended intervals, clean and/or replace the filter as stated in the Operator's Manual.

7. Parts damaged by over-speeding, or overheating caused by grass, debris, or dirt, which plugs or clogs the cooling fins, or flywheel area, or damage caused by operating the engine in a confined area without sufficient ventilation. Clean engine debris at recommended intervals as stated in the Operator's Manual.
8. Engine or equipment parts broken by excessive vibration caused by a loose engine mounting, loose cutter blades, unbalanced blades or loose or unbalanced impellers, improper attachment of equipment to engine crankshaft, over-speeding or other abuse in operation.
9. A bent or broken crankshaft, caused by striking a solid object with the cutter blade of a rotary lawn mower, or excessive v-belt tightness.
10. Routine tune-up or adjustment of the engine.
11. Engine or engine component failure, i.e., combustion chamber, valves, valve seats, valve guides, or burned starter motor windings, caused by the use of alternate fuels such as, liquified petroleum, natural gas, altered gasolines, etc.

**Warranty service is available only through authorized service dealers by Briggs & Stratton Corporation. Locate your nearest Authorized Service Dealer in our dealer locator map on [www.briggsandstratton.com](http://www.briggsandstratton.com) or by calling 1-800-2333723, or as listed in the "Yellow Pages™".**

7

1

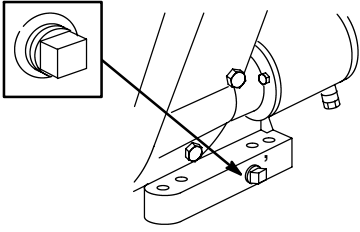

2

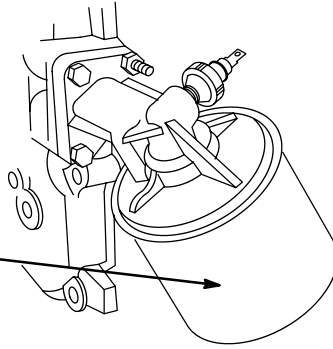

8

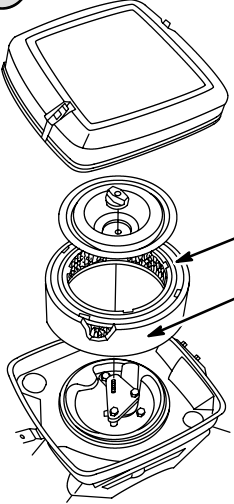

1

2

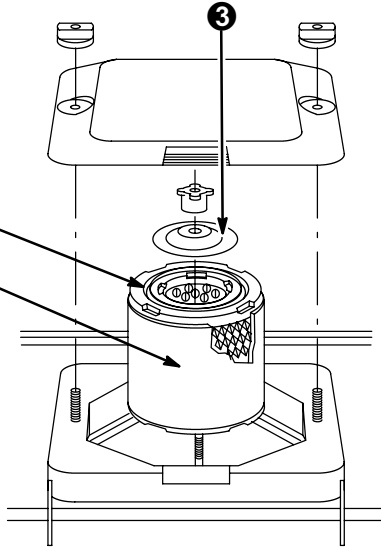

3

9

1

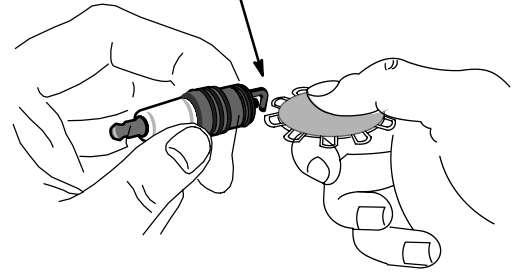

10

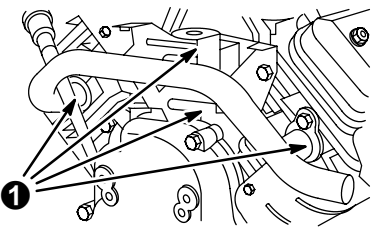

1

2

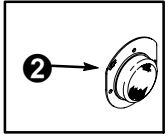

3

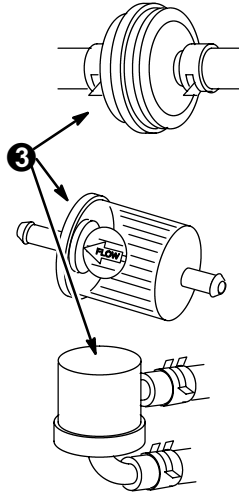

11

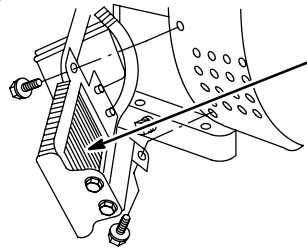

1

2

