

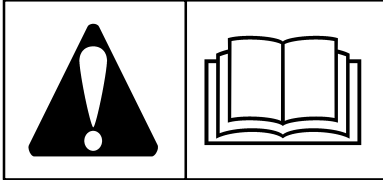

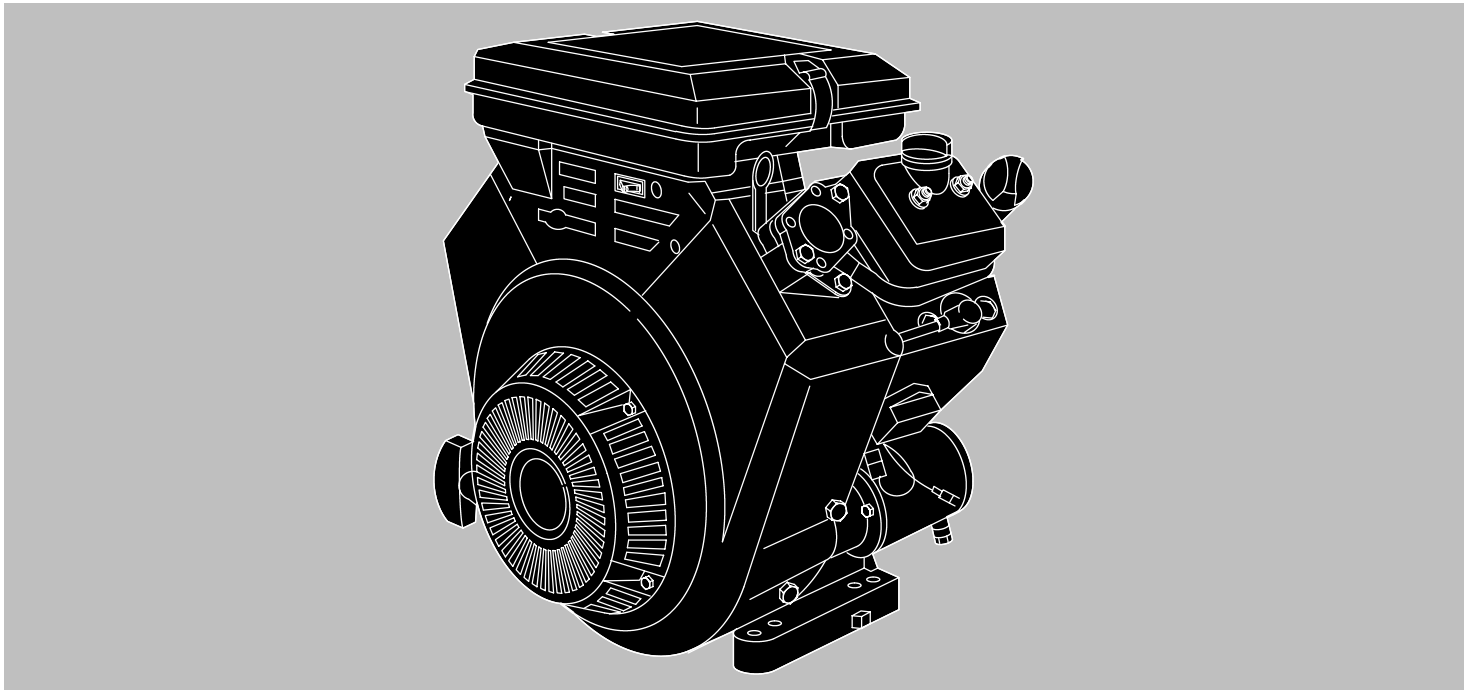

290000, 300000, 350000, 380000





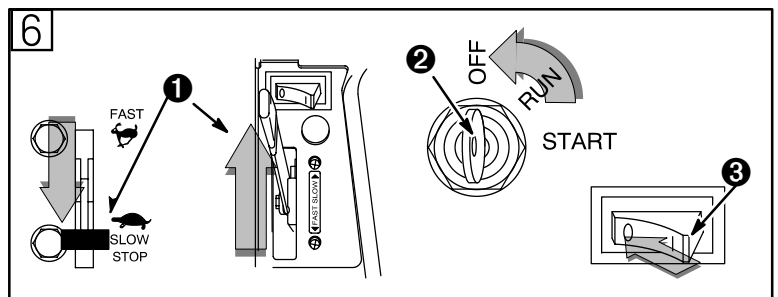
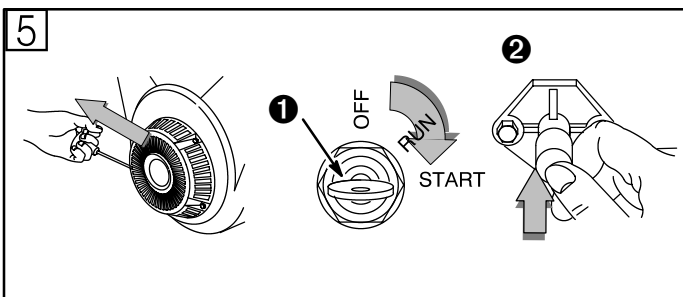
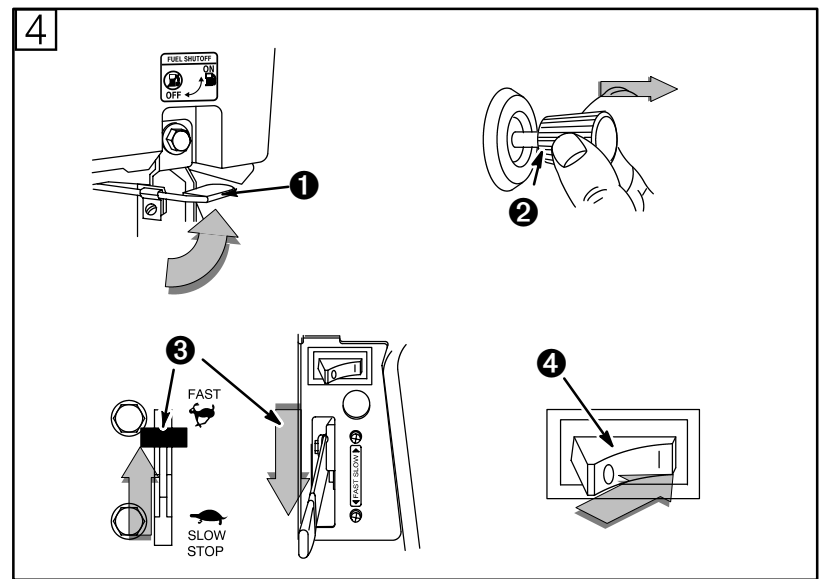
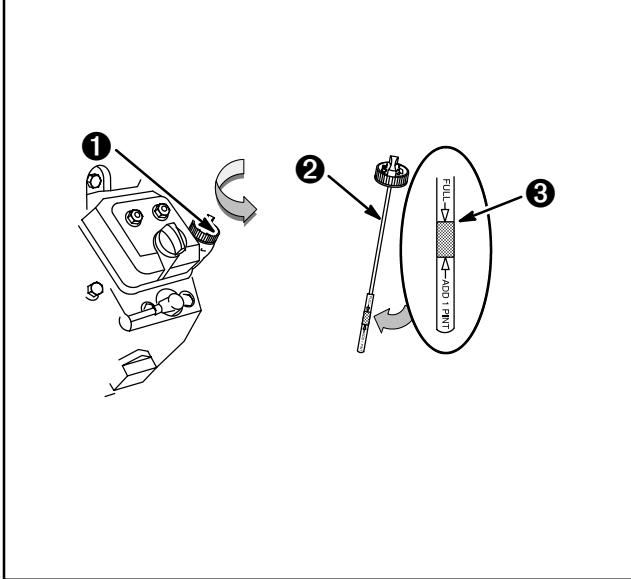
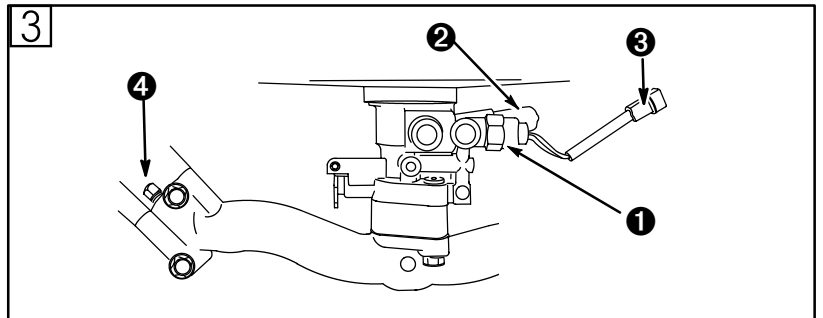
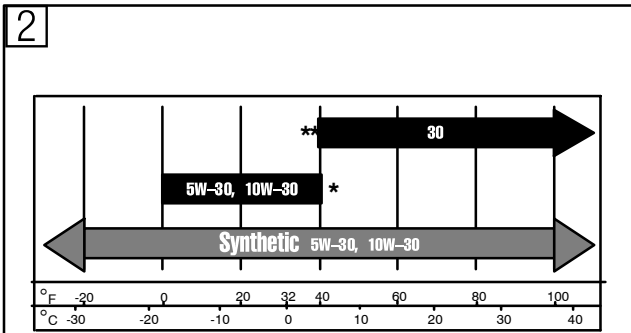
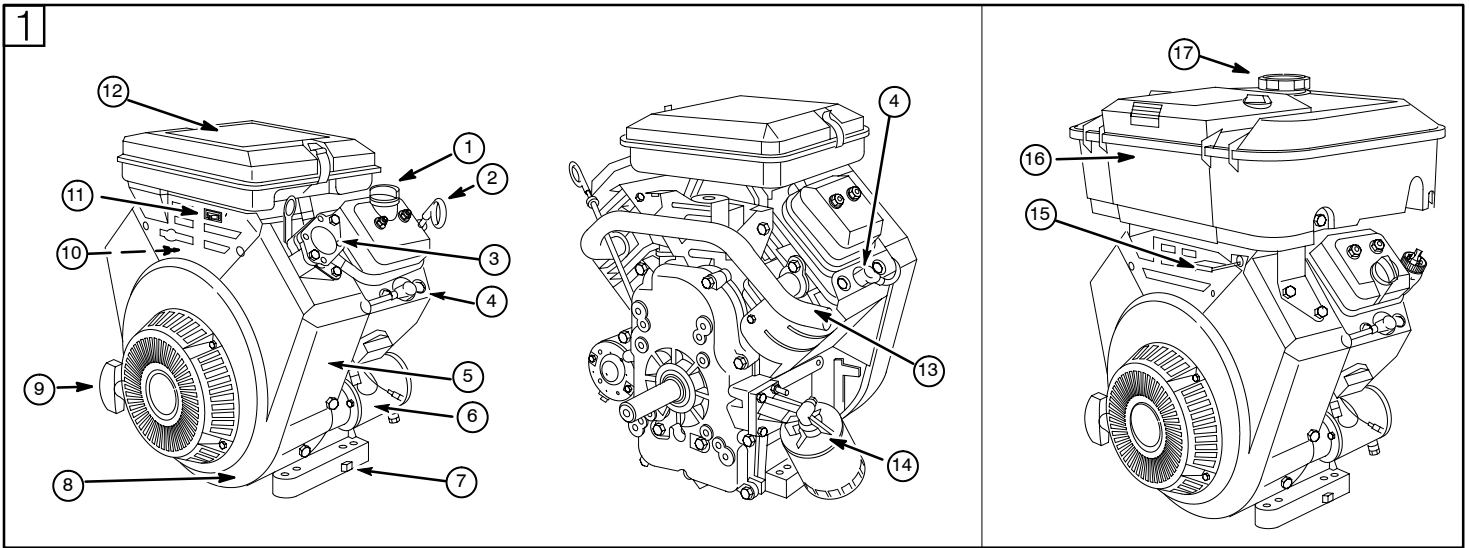



- (GB) *Operating & Maintenance Instructions***
- (D) *Betriebsanleitung & Wartungsvorschriften***
- (DK) *Drifts- og vedligeholdelsesvejledning***
- (E) *Instrucciones de Mantenimiento & Operación***
- (F) *Instructions d'utilisation et de maintenance***
- (GR) *Ίαçãßàò Èåéôïñãßàò & Óôíôñçòçò***
- (I) *Istruzioni per l'uso e la manutenzione***
- (N) *Anvisninger for bruk og vedlikehold***
- (NL) *Gebruiksaanwijzing***
- (P) *Instruções de operação e de manutenção***
- (S) *Instruktionsbok***
- (SF) *Käyttö & Huolto-ohjeet***





Note: (This note applies only to engines used in the U.S.A.) Maintenance, replacement or repair of the emission control devices and systems may be performed by any nonroad engine repair establishment or individual. However, to obtain no charge repairs under the terms and provisions of the Briggs & Stratton warranty statement, any service or emission control part repair or replacement must be performed by a factory authorized dealer. 

How To Use Manual Figures

-  -  refer to figures inside covers.
-  -  refer to engine components in figure .
-  -  refer to part/action in figures.

Record your engine Model, Type and Code numbers here for future use.

















Record your date of purchase here for future use.

In the state of California, OHV Model Series 290000, 300000, 350000 and 380000 engines are certified by the California Air Resources Board to meet emissions standards for 250 hours. Such certification does not grant the purchaser, owner or operator of this engine any additional warranties with respect to the performance or operational life of this engine. This engine is warranted solely according to the product and emissions warranties stated elsewhere in this manual.



Technical Information

POWER RATINGS: The power ratings for an individual engine model are initially developed by starting with SAE (Society of Automotive Engineers) code J1940 (Small Engine Power & Torque Rating Procedure) (Revision 2002-05). Given both the wide array of products on which our engines are placed, and the variety of environmental issues applicable to operating the equipment, it may be that the engine you have purchased will not develop the rated horsepower when used in a piece of power equipment (actual "on-site" power). This difference is due to a variety of factors including, but not limited to, the following: differences in altitude, temperature, barometric pressure, humidity, fuel, engine lubrication, maximum governed engine speed, individual engine to engine variability, design of the particular piece of power equipment, the manner in which the engine is operated, engine run-in to reduce friction and clean out of combustion chambers, adjustments to the valves and carburetor, and other factors. The power ratings may also be adjusted based on comparisons to other similar engines utilized in similar applications, and will therefore not necessarily match the values derived using the foregoing codes.

Engine Components (see fig.)

-  Oil fill cap
-  Dipstick
-  Fuel pump (if equipped)
-  Spark plug
-  **Engine Model Type Code**
xxxxxx xxxx xx xxxxxxxx
-  12V electric starter (if equipped)
-  Oil drain plug
-  Blower housing
-  Rope handle
-  Carburetor or LPG/NG Fuel mixer
-  Stop switch (if equipped)
-  Air cleaner (without fuel tank)
-  Fuel shut-off valve (if equipped)
-  Air cleaner (with fuel tank)
-  Fuel fill/fuel tank (if equipped)
-  Exhaust manifold
-  Oil filter (if equipped)

Safety Precautions

  **BEFORE OPERATING ENGINE**

- Read entire Operating & Maintenance Instructions AND the instructions for the equipment this engine powers.*
- Failure to follow instructions could result in serious injury or death.

* Briggs & Stratton does not necessarily know what equipment this engine will power. For that reason, you should carefully read and understand the operating instructions for the equipment on which your engine is placed.

THE OPERATING & MAINTENANCE INSTRUCTIONS CONTAIN SAFETY INFORMATION TO

- Make you aware of hazards associated with engines
- Inform you of the risk of injury associated with those hazards, and
- Tell you how to avoid or reduce the risk of injury.

Hazard Symbols and Meanings

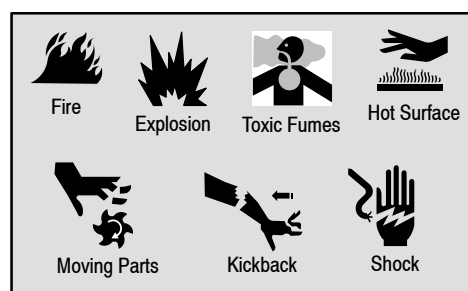

 The safety alert symbol is used to identify safety information about hazards that can result in personal injury.

A signal word (DANGER, WARNING, or CAUTION) is used with the alert symbol to indicate the likelihood and the potential severity of injury. In addition, a hazard symbol may be used to represent the type of hazard.

 **DANGER** indicates a hazard which, if not avoided, will result in death or serious injury.



 **WARNING** indicates a hazard which, if not avoided, could result in death or serious injury.

 **CAUTION** indicates a hazard which, if not avoided, might result in minor or moderate injury.

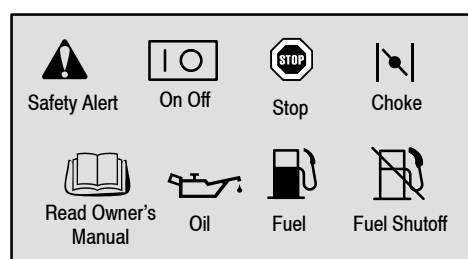

CAUTION, when used **without** the alert symbol, indicates a situation that **could result in damage to the engine.**



International Symbols and Meanings







 **WARNING** 



The engine exhaust from this product contains chemicals known to the State of California to cause cancer, birth defects, or other reproductive harm.



 WARNING

Gasoline and its vapors are extremely flammable and explosive. Fire or explosion can cause severe burns or death.
<p>WHEN FUELING</p> <ul style="list-style-type: none"> • Turn engine OFF and let engine cool at least 2 minutes before refueling engine. • Fill fuel tank outdoors or in well-ventilated area. • On GASOLINE operated engines, do not overfill fuel tank. Fill tank to approximately 1-1/2 inches below top of neck to allow for fuel expansion. • Keep fuel away from sparks, open flames, pilot lights, heat, and other ignition sources. • Check fuel lines, tank, cap, and fittings frequently for cracks or leaks. Replace if necessary. <p>WHEN STARTING ENGINE</p> <ul style="list-style-type: none"> • Make sure spark plug, muffler, fuel cap and air cleaner are in place. • Do not crank engine with spark plug removed. • If fuel spills, wait until it evaporates before starting engine. • If GASOLINE engine floods, set choke to OPEN/RUN position, place throttle in FAST and crank until engine starts. <p>WHEN OPERATING EQUIPMENT WITH GASOLINE ENGINE</p> <ul style="list-style-type: none"> • Do not tip engine or equipment at angle which causes gasoline to spill. • Do not choke carburetor to stop engine. <p>WHEN TRANSPORTING EQUIPMENT</p> <ul style="list-style-type: none"> • On gasoline engine, transport with fuel tank EMPTY or with fuel shut-off valve OFF. • On NATURAL / LIQUID PETROLEUM (LP) GAS engine, transport with fuel cylinder empty, and valve closed, or tank disconnected. <p>WHEN STORING FUEL OR EQUIPMENT WITH FUEL IN TANK OR IN FUEL CYLINDER</p> <ul style="list-style-type: none"> • Store away from furnaces, stoves, water heaters or other appliances that have pilot light or other ignition source because they can ignite gasoline vapors.



 WARNING

Engines give off carbon monoxide, an odorless, colorless, poison gas. Breathing carbon monoxide can cause nausea, fainting or death.
<ul style="list-style-type: none"> • Start and run engine outdoors. • Do not start or run engine in enclosed area, even if doors or windows are open.

 WARNING

Gaseous fuels are extremely flammable and readily form explosive air-vapor mixtures at ambient temperatures.
<p>IF YOU SMELL GAS:</p> <ul style="list-style-type: none"> • DO NOT start the engine. • DO NOT actuate any electrical switches. • DO NOT use the phone in the vicinity. • Evacuate the area. • Contact the gas supplier or fire department. <p>REMEMBER:</p> <ul style="list-style-type: none"> • LPG vapor is heavier than air and tends to collect in low areas. NG vapor is lighter than air and tends to collect in high areas. Both may travel to remote locations. • Keep all flames, sparks, pilot lights, and other ignition sources away from the area where the engine is operated or repaired. • DO NOT smoke when operating or repairing the engine. • DO NOT store gasoline or other flammable vapors or liquids in the vicinity of the engine. • BEFORE doing any service work to the engine, shut off the gas supply. • After initial installation or servicing, check for gas leaks. DO NOT use an open flame. Apply very soapy water or leak test solution with a brush and look for bubbles. • Keep the equipment and the area surrounding the engine free of debris. • Install the fuel system according to applicable fuel/gas codes.

 WARNING

Wear eye protection when doing repair work. Frostbite can result from skin/eye contact with leaking LP liquid.
<ul style="list-style-type: none"> • Installation, adjustment and repair work should be done by a qualified technician. • Flexible supply lines should be checked regularly to make sure they are in good condition. Replace damaged or leaking components.

 WARNING

Unintentional sparking can result in fire or electric shock. Unintentional start-up can result in entanglement, traumatic amputation, or laceration.
<p>BEFORE PERFORMING ADJUSTMENTS OR REPAIRS</p> <ul style="list-style-type: none"> • Disconnect spark plug wire and keep it away from spark plug. • Disconnect battery at negative terminal (only engines with electric start). <p>WHEN TESTING FOR SPARK</p> <ul style="list-style-type: none"> • Use approved spark plug tester. • Do not check for spark with spark plug removed.

 WARNING

Starting engine creates sparking. Sparking can ignite nearby flammable gases. Explosion and fire could result.
<ul style="list-style-type: none"> • If there is natural or LP gas leakage in area, do not start engine. • Do not use pressurized starting fluids because vapors are flammable.

 WARNING

Running engines produce heat. Engine parts, especially muffler, become extremely hot. Severe thermal burns can occur on contact. Combustible debris, such as leaves, grass, brush, etc. can catch fire.
<ul style="list-style-type: none"> • Allow muffler, engine cylinder and fins to cool before touching. • Remove accumulated combustibles from muffler area and cylinder area. • Install and maintain in working order a spark arrester before using equipment on forest-covered, grass-covered, brush-covered unimproved land. The state of California requires this (Section 4442 of the California Public Resources Code). Other states may have similar laws. Federal laws apply on federal land.

WARNING



Rotating parts can contact or entangle hands, feet, hair, clothing, or accessories.

Traumatic amputation or severe laceration can result.

- Operate equipment with guards in place.
- Keep hands and feet away from rotating parts.
- Tie up long hair and remove jewelry.
- Do not wear loose-fitting clothing, dangling drawstrings or items that could become caught.

WARNING



Rapid retraction of starter cord (kickback) will pull hand and arm toward engine faster than you can let go.

Broken bones, fractures, bruises or sprains could result.

- When starting engine, pull cord slowly until resistance is felt, then pull rapidly.
- Remove all external equipment/engine loads before starting engine.
- Direct coupled equipment components such as, but not limited to, blades, impellers, pulleys, sprockets, etc., must be securely attached.

Oil Recommendations (see fig. 2)

Engine shipped from Briggs & Stratton **without** oil. **Before starting engine, fill with oil. Do not over-fill.**

Use a high quality detergent oil classified "For Service SF, SG, SH, SJ" or higher such as Briggs & Stratton 30W, Part Number 100005 (20 oz.) or 100028 (48 oz.). Use no special additives with recommended oils. Do not mix oil with gasoline.

Choose the SAE viscosity grade of oil from this chart that matches the starting temperature anticipated before the next oil change. (see fig. 2)

Note: Synthetic oil meeting ILSAC GF-2, API certification mark and API service symbol (shown at left) with "SJ/CF ENERGY CONSERVING" or higher, is an acceptable oil at all temperatures. **Use of synthetic oil does not alter required oil change intervals.**



* Air cooled engines run hotter than automotive engines. The use of non-synthetic multi-viscosity oils (5W-30, 10W-30, etc.) in temperatures above 40° F (4° C) will result in higher than normal oil consumption. When using a multi-viscosity oil, check oil level more frequently.

** SAE 30 oil, if used below 40° F (4° C), will result in hard starting and possible engine bore damage due to inadequate lubrication.

Check oil level (see fig. 2)

Oil capacity: approximately 1-1/2 quarts (48 ounces or 1.6 liters) when changing oil and **filter**. (Oil capacity will be greater if engine is equipped with **remote** oil filter.)

Oil filling procedure: first add 1 quart (32 ounces or 1 liter). Start and run engine at idle for 30 seconds. Shut engine off and wait 30 seconds. Then add more oil slowly to bring level to **Full** mark on dipstick. Check for oil leaks. Tighten dipstick firmly before starting engine.

Oil checking procedure: before starting engine, place engine level and clean around oil fill ❶. Remove dipstick ❷, wipe with clean cloth, insert and tighten down again. Remove dipstick and check oil level. Oil should be at **FULL** mark ❸. If oil is required, add slowly. Tighten dipstick firmly before starting engine.

Fuel Recommendations

Gasoline Powered Engines

Use clean, fresh, **lead-free** gasoline with a minimum of 85 octane. Leaded gasoline may be used if it is commercially available and if unleaded is unavailable. Purchase fuel in quantity that can be used within 30 days.

Do not use gasoline which contains Methanol. Do not mix oil with gasoline. In U.S.A. leaded gasoline may not be used.

This engine is certified to operate on gasoline. Exhaust Emission Control System: EM (Engine Modifications).

For engine protection, we recommend using Briggs & Stratton Fuel Stabilizer available from an Authorized Briggs & Stratton Service Dealer.

Natural (NG) / Liquid Propane (LPG) Gas Powered Engines

Use clean, dry fuel, free of moisture or any particulate material. Using fuels outside the following recommended values may cause performance problems.

In engines set up to run on LPG, commercial grade HD5 LPG is recommended. Recommended fuel composition is fuel with a minimum fuel energy of 2500 BTU's/ft³ with maximum propylene content of 5% and butane and heavier gas content of 2.5% and minimum propane content of 90%.

NG or LPG engines are certified to operate on natural or liquid propane gas.



The equipment on which this engine is mounted is equipped with an automatic safety gas "fuel lock-off" valve. DO

NOT operate the equipment if the "fuel lock-off" valve is missing or inoperative.

Adding Fuel - Gasoline



Before refueling, allow engine to cool 2 minutes.

Clean around fuel fill before removing cap to refuel. Remove cap. Fill tank to approximately 1-1/2 inches below top of neck to allow for fuel expansion. Be careful not to overfill.

Adding Fuel - Natural (NG) / Liquid Propane (LPG)

Read the operating instructions supplied by the equipment manufacturer for information on refueling natural or LP gas engine.

Starting (see figs. 3 4)



ALWAYS KEEP HANDS AND FEET CLEAR OF EQUIPMENT MOVING PARTS.



Do not use a pressurized starting fluid. Vapors are flammable.

Start, store and fuel equipment in level position.

Check oil level.

Open fuel shut-off valve, if equipped.

BEFORE STARTING - LPG / NG Engines (see fig. 3)

The LPG / NG mixer is equipped with solenoid ❶, fuel inlet ❷, 12 volt connector ❸, and equipped for a fuel lock-off valve ❹.

CAUTION:

All LPG / NG fuel mixers are equipped with a solenoid. ❶ When operating on **LPG** fuel, 12 volts **MUST** be supplied to connector ❸.

When operating on **NG** fuel, 12 volts **MUST NOT** be supplied to connector ❸.

1. Move throttle control to FAST position.
2. Push rocker switch to I position.

BEFORE STARTING - Gasoline Engines (see fig. 4)

If engine runs low on oil, an **oil pressure switch** (if engine is equipped) will either activate a warning device or stop the engine. (Read the operating instructions supplied by the equipment manufacturer to determine which way your engine is equipped.) See **Oil pressure** on next page.

1. Open fuel shut-off valve ❶, if equipped.
2. Move choke control ❷ to CHOKE position.

Note: If engine does not start, remove air cleaner to check choke. Choke must fully close. If not, see **Adjustments**.

3. Move throttle control ❸ to FAST position.
4. Push rocker switch ❹ to I position.

Rewind starter, if equipped (see fig. 5)



Grasp rope handle and pull slowly until resistance is felt. Then pull cord rapidly to overcome compression, prevent kickback and start engine. Repeat if necessary with choke in RUN position throttle in FAST. When engine starts, operate in FAST.

Electric starter (see fig. 5)

On engines equipped with 12 volt starting systems, turn key to START position ❶ or press button ❷. Repeat if necessary with choke off and throttle control in FAST position. Operate engine with choke off and throttle in FAST position.

Note: If equipment manufacturer has supplied battery, charge it before trying to start engine, as equipment manufacturer recommends. Use short starting cycles (15 secs. per min.) to prolong starter life. Extended cranking can damage starter motor.

CAUTION: If engine is equipped with battery for electric starter, do not operate engine with battery disconnected.

Stopping (see fig. 6)

Do not move choke control to CHOKE to stop engine. Backfire or engine damage may occur. Move throttle control ❶ to IDLE or SLOW position, then to STOP or turn key to OFF ❷ or push rocker switch ❸ to 0 position.

Always remove key from switch when equipment is not in use or left unattended.



When engine or equipment is transported, close fuel shut-off valve, if equipped, to prevent fuel leakage.

Maintenance Schedule

Follow the hourly or calendar intervals, whichever occur first. More frequent service is required when operating in adverse conditions noted below.

First 8 Hours

- Change oil

Every 8 hours or daily

- Check oil level
- Clean around muffler, linkage and springs

Every 25 hours or every season

- Change oil if operating under heavy load or high ambient temperature
- Service air cleaner pre-cleaner*

Every 50 hours or every season

- Change oil
- Clean and inspect spark arrester, if equipped

Every 100 hours or every season

- Service air cleaner cartridge*
- Replace oil filter, if equipped
- Clean oil cooler, if equipped*
- Clean cooling system*
- Check valve clearance - NG / LPG engines

Every season

- Replace spark plugs
- Replace in-line fuel filter
- Check valve clearance

* Clean more often under dusty conditions, or when airborne debris is present or after prolonged operation cutting tall, dry grass.

Maintenance (see figs. 8 9 10)

See any Authorized Briggs & Stratton Dealer for correct replacement parts.



To prevent accidental starting, remove spark plug wire 1 and ground it before servicing, and disconnect battery at negative terminal, if equipped.

Oil service (see fig. 8)

Check oil level regularly.

Be sure correct oil level is maintained. Check every 8 hours or daily, before starting engine. See oil filling procedure, **Oil Recommendations**.

Change oil.

Change oil after first 8 hours of operation. Change oil while engine is warm. Refill with new oil of recommended SAE viscosity grade. (see fig. 2)

Change oil filter 2, if equipped. (see fig. 8)

Replace oil filter after every 100 hours of operation or every season, whichever occurs first. Before installing new filter, lightly oil filter gasket with fresh, clean engine oil. Screw filter on by hand until gasket contacts oil filter adapter. Tighten 1/2 to 3/4 turn more. Start and run engine at IDLE to check for oil leaks. Stop engine. Recheck oil level and add oil if required.

Oil pressure

If oil pressure drops below 1-4 psi (.1-.2 kg/cm²), an oil pressure switch (if engine is equipped) will either activate a warning device or stop the engine. Check oil level with dipstick. If oil level is between **ADD** and **FULL** mark on dipstick, **do not try to restart engine**. Contact an Authorized Briggs & Stratton Service Dealer. **Do not operate engine until oil pressure is corrected.**

If oil level is below **ADD** mark on dipstick, add oil to bring level to **FULL** mark. Restart engine and check oil pressure. If pressure is normal, continue to operate engine.

Note: Oil pressure gauge, if engine is equipped, is supplied by manufacturer of equipment.

Maintenance Cont'd

Air cleaner, dual element (see fig. 9)

1. Remove cover.
2. Carefully slide pre-cleaner 2 off cartridge 3.
3. Remove knob and plate. Carefully remove cartridge to prevent debris from entering carburetor.

Replace pre-cleaner, if equipped, or cartridge if very dirty or damaged.

To service cartridge, clean by tapping gently on a flat surface. Do not use petroleum solvents, e.g., kerosene, which will cause cartridge to deteriorate. Do not use pressurized air, which can damage cartridge. Do not oil cartridge.

4. Reinstall cartridge, plate and knob.

Note: Top side of air cleaner plate 4 is marked "UP" (only on engines equipped with integral fuel tank).

5. Install pre-cleaner on cartridge and replace cover.

Spark plug service (see fig. 10)



DO NOT check for spark with spark plugs removed. Use only Briggs & Stratton Spark Tester 2, to check for spark.

DO NOT crank engine with spark plug removed. If engine is flooded, place throttle in FAST and crank until engine starts.

Spark plug gap 3 should be .76 mm or 0.030 in.

Replace spark plugs every season. Spark tester and spark plug wrench are available from any Authorized Briggs & Stratton Service Dealer.

Note: In some areas, local law requires using a resistor spark plug to suppress ignition signals. If this engine was originally equipped with resistor spark plug, use same type of spark plug for replacement.

Keep engine clean (see fig. 10)

Periodically remove chaff/debris buildup from engine. Do not spray engine with water because water could contaminate fuel. Use a brush or compressed air.



Accumulation of chaff/debris around exhaust manifold/muffler 4 could cause a fire. Inspect and clean before every use.

Keep linkage, springs and controls 4 free of debris.

If muffler is equipped with spark arrester screen 5, remove spark arrester screen for cleaning and inspection every 50 hours or every season. Replace if damaged.



Replace in-line fuel filter 6 every season. Drain fuel tank or close fuel shut-off valve before replacing filter.

Clean oil cooler 7 every 100 hours or every season, if equipped.

Chaff or debris may clog engine's air cooling system, especially after prolonged service. Every 100 hours or every season, clean internal cooling fins and surfaces to prevent overheating and engine damage. Remove blower housing to clean areas shown 8.

Check Valve Clearance

Gasoline Engines -

Check valve clearance yearly (intake and exhaust .10-.15 mm).

NG / LPG Engines -

Valve clearance must be checked after every 100 hours of operation. Adjust if necessary.

Adjustments (see fig. 7)



To prevent accidental starting, remove spark plug wire 1 and ground it before adjusting, and disconnect battery at negative terminal, if equipped.

Carburetor adjustments



The manufacturer of the equipment on which this engine is installed specifies top speed at which the engine will be operated. DO NOT EXCEED this speed.

See an Authorized Briggs & Stratton Dealer for carburetor adjustment.

Start engine and warm up approximately 5 minutes before adjusting. With engine running, place throttle control in SLOW position. Rotate carburetor throttle lever against the idle speed screw and hold it. Turn idle speed screw to obtain 1400 rpm (1200 rpm on twin barrel carburetor). While still holding carburetor throttle lever against idle speed screw, turn idle mixture valve with limiter cap screw midway between limits. DO NOT remove limiter cap. DO NOT force beyond limit. On two barrel carburetor, set cylinder #1 idle mixture valve midway between limits. Then set cylinder #2 idle mixture valve midway between limits while holding carburetor throttle lever against idle speed screw.

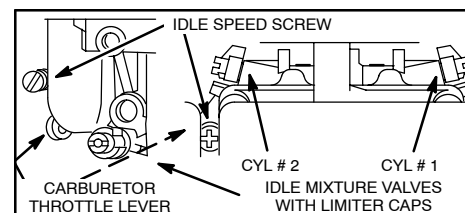

Single barrel carburetor

Two barrel carburetor

Readjust the idle speed to 1200 rpm, if governed idle spring is red, or 900 rpm, if governed idle spring is white as illustrated below. Release carburetor throttle lever. Move throttle control to FAST position.

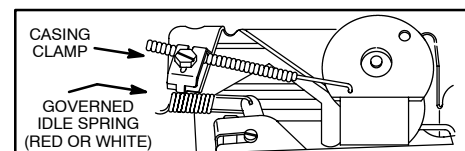

Note: Engines operated at approximately 3000 to 5000 feet above sea level may require a high altitude carburetor main jet. See a Briggs & Stratton Dealer.

ON NG / LPG Powered Engines

Adjusting Fuel Mixer

If adjustment is needed, see a Briggs & Stratton Authorized Service Dealer who has been licensed by the state or local municipality (if required) in which the service is performed. Mixer adjustment requires special equipment and a qualified technician. DO NOT remove limiter caps. DO NOT force beyond limits.

Adjustments Cont'd (see fig. 7)

Choke control adjustments

Remove air cleaner. Move choke control to CHOKE position. Carburetor choke valve ② should be completely closed. If not, loosen casing clamp screw ③ and pull casing and wire ④ in direction of arrow to end of travel. Tighten casing clamp screw. Replace air cleaner.

Throttle control adjustments ⑤

Remove air cleaner. Move throttle control to FAST position. Swivel ⑤ should be against throttle stop ⑥. If not, loosen casing clamp screw ⑦. Move casing and wire ⑧ in direction shown by arrow until swivel is against throttle stop. Tighten casing clamp screw. Check operation of controls. Readjust if necessary. Replace air cleaner.

Adjustable Governor Control

This control ⑨ was set according to requirements of manufacturer of the equipment on which this engine is installed. If adjustment is required, consult any Briggs & Stratton Authorized Service Dealer.

Storage

Engines stored over 30 days need to be protected or drained of fuel to prevent gum from forming in fuel system or on essential carburetor parts.

For engine protection, we recommend use of Briggs & Stratton Fuel Stabilizer available from an Authorized Briggs & Stratton Service Dealer. Mix stabilizer with fuel in fuel tank or storage container. Run engine for a short time to circulate stabilizer through carburetor. Engine and fuel can be stored up to 24 months.

Note: If stabilizer is not used or if engine is operating on gasoline containing alcohol, e.g. gasohol, remove all fuel from tank and run engine until it stops from lack of fuel.

1. Change oil. See **Oil service.** (see figs. 2, 7)
2. Remove spark plugs and pour about 30 ml (1 oz) of engine oil into cylinders. Replace spark plugs and crank slowly to distribute oil.
3. Clean chaff or debris from cylinders and cylinder head fins and behind muffler.
4. Store in a clean and dry area, but NOT near a stove, furnace or water heater which uses a pilot light or any device that can create a spark.

Service

See an Authorized Briggs & Stratton Service Dealer. Each one carries a stock of Genuine Briggs & Stratton Parts and is equipped with special service tools. Trained mechanics assure expert repair service on all Briggs & Stratton engines. Only dealers advertising as "Authorized Briggs & Stratton" are required to meet Briggs & Stratton standards.

When you purchase equipment powered by a Briggs & Stratton engine, you are assured of highly skilled, reliable service at more than 30,000 Authorized Service Dealers worldwide, including more than 5,000 Master Service Technicians. Look for these signs wherever Briggs & Stratton service is offered.



You may locate your nearest Authorized Briggs & Stratton Service Dealer in our dealer locator map on our web site

www.briggsandstratton.com or in the "Yellow Pages"™ directory under "Engines, Gasoline" or "Gasoline Engines," or "Lawn Mowers" or similar category.



Note: Walking fingers logo and "Yellow Pages" are registered trademarks in various jurisdictions.

An illustrated shop manual includes "Theories of Operation," common specifications and detailed information covering adjustment, tune-up and repair of Briggs & Stratton V-Twin cylinder OHV, 4 cycle engines. Order P/N 272144 from an Authorized Briggs & Stratton Service Dealer.

Insist on Genuine Briggs & Stratton replacement parts with our logo on the box and/or part. Non-original parts may not perform as well and may void your warranty.

Partial List of Genuine Briggs & Stratton Parts

<u>Part</u>	<u>Part No.</u>
Oil (20 oz.)	100005
Oil (48 oz.)	100028
Oil filter (6 cm long)	492932 (5049)
Oil filter (9 cm long)	491056
Oil pump kit (uses standard electric drill to remove oil from engine quickly)	5056
Fuel stabilizer (1 oz., 30 ml single use pouch)	992030
Fuel stabilizer (4.2 oz., 125 ml bottle)	999005E (5041)
Fuel filter (without fuel pump)	298090 (5018)
Fuel filter (with fuel pump)	493629
Fuel filter (with 9 qt. fuel tank on engine)	808116
Air cleaner cartridge (with 9 qt. fuel tank on engine)	393957
Air cleaner pre-cleaner (with 9 qt. fuel tank on engine)	271794
Air cleaner cartridge (all other models except model 380000)	394018
Air cleaner pre-cleaner (all other models except model 380000)	272490
Air cleaner (cartridge and pre-cleaner kit) (all other models except model 380000)	5050
Air cleaner cartridge (model 380000)	692519
Air cleaner pre-cleaner (model 380000)	692520
Resistor spark plug	491055 or 496018
Long life platinum spark plug (used on most OHV engines)	5066
Spark tester	19368
Spark plug wrench	19374
Spark arrester	392390
Resistor spark plug	491055 or 496018

BRIGGS & STRATTON ENGINE OWNER WARRANTY POLICY

Effective July 1, 2004 replaces all undated Warranties and all Warranties dated before July 1, 2004

LIMITED WARRANTY

Briggs & Stratton Corporation will repair or replace, free of charge, any part(s) of the engine that is defective in material or workmanship or both. Transportation charges on parts submitted for repair or replacement under this warranty must be borne by purchaser. This warranty is effective for the time periods and subject to the conditions stated below. For warranty service, find the nearest Authorized Service Dealer in our dealer locator map at www.briggsandstratton.com, or by calling 1-800-233-3723, or as listed in the 'Yellow Pages™'.

THERE IS NO OTHER EXPRESS WARRANTY. IMPLIED WARRANTIES, INCLUDING THOSE OF MERCHANTABILITY AND FITNESS FOR A PARTICULAR PURPOSE, ARE LIMITED TO ONE YEAR FROM PURCHASE, OR TO THE EXTENT PERMITTED BY LAW ANY AND ALL IMPLIED WARRANTIES ARE EXCLUDED. LIABILITY FOR INCIDENTAL OR CONSEQUENTIAL DAMAGES ARE EXCLUDED TO THE EXTENT EXCLUSION IS PERMITTED BY LAW. Some states or countries do not allow limitations on how long an implied warranty lasts, and some states or countries do not allow the exclusion or limitation of incidental or consequential damages, so the above limitation and exclusion may not apply to you. This warranty gives you specific legal rights and you may also have other rights which vary from state to state and country to country.

OUR PRODUCT

Vanguard™	ELS™ I/C® Industrial Plus™ Intek™ (Sleeve Bore)	Force™ Intek™ (Kool Bore) Power Built™ OHV Quantum® Quattro™ Q45™ Sprint™	Classic™	Etek™
-----------	---	--	----------	-------

WARRANTY PERIOD*

	Vanguard™	ELS™ I/C® Industrial Plus™ Intek™ (Sleeve Bore)	Force™ Intek™ (Kool Bore) Power Built™ OHV Quantum® Quattro™ Q45™ Sprint™	Classic™	Etek™
Consumer Use	2 years	2 years	2 years	1 year	1 year
Commercial Use	2 years	1 year	90 days	90 days	1 year

* Note the following special warranty periods: 2 years for Classic™ engines in the European Union and Eastern European countries, for all consumer products in the European Union, and for emission control systems on engines certified by EPA and CARB. 5 years for consumer use, 90 days for commercial use of Touch-N-Mow® starter on Quantum® and Intek™ engines. Engines used in competitive racing or on commercial or rental tracks are not warranted.

The warranty period begins on the date of purchase by the first retail consumer or commercial end user, and continues for the period of time stated in the table above. "Consumer use" means personal residential household use by a retail consumer. "Commercial use" means all other uses, including use for commercial, income producing or rental purposes. Once an engine has experienced commercial use, it shall thereafter be considered as a commercial use engine for purposes of this warranty.

NO WARRANTY REGISTRATION IS NECESSARY TO OBTAIN WARRANTY ON BRIGGS & STRATTON PRODUCTS. SAVE YOUR PROOF OF PURCHASE RECEIPT. IF YOU DO NOT PROVIDE PROOF OF THE INITIAL PURCHASE DATE AT THE TIME WARRANTY SERVICE IS REQUESTED, THE MANUFACTURING DATE OF THE PRODUCT WILL BE USED TO DETERMINE THE WARRANTY PERIOD.

ABOUT YOUR ENGINE WARRANTY

Briggs & Stratton welcomes warranty repair and apologizes to you for being inconvenienced. Any Authorized Service Dealer may perform warranty repairs. Most warranty repairs are handled routinely, but sometimes requests for warranty service may not be appropriate. For example, warranty would not apply if engine damage occurred because of misuse, lack of routine maintenance, shipping, handling, warehousing or improper installation. Similarly, warranty is void if the serial number of the engine has been removed or the engine has been altered or modified.

If a customer differs with the decision of the Service Dealer, an investigation will be made to determine whether the warranty applies. Ask the Service Dealer to submit all supporting facts to his Distributor or the Factory for review. If the Distributor or the Factory decides that the claim is justified, the customer will be fully reimbursed for those items that are defective. To avoid misunderstanding which might occur between the customer and the Dealer, listed below are some of the causes of engine failure that the warranty does not cover.

Normal wear:

Engines, like all mechanical devices, need periodic parts service and replacement to perform well. Warranty will not cover repair when normal use has exhausted the life of a part or an engine.

Improper maintenance:

The life of an engine depends upon the conditions under which it operates, and the care it receives. Some applications, such as tillers, pumps and rotary mowers, are very often used in dusty or dirty conditions, which can cause what appears to be premature wear. Such wear, when caused by dirt, dust, spark plug cleaning

grit, or other abrasive material that has entered the engine because of improper maintenance, is not covered by warranty.

This warranty covers engine related defective material and/or workmanship only, and not replacement or refund of the equipment to which the engine may be mounted. Nor does the warranty extend to repairs required because of:

1. PROBLEMS CAUSED BY PARTS THAT ARE NOT ORIGINAL BRIGGS & STRATTON PARTS.
2. Equipment controls or installations that prevent starting, cause unsatisfactory engine performance, or shorten engine life. (Contact equipment manufacturer.)
3. Leaking carburetors, clogged fuel pipes, sticking valves, or other damage, caused by using contaminated or stale fuel. (Use clean, fresh, lead-free gasoline and Briggs & Stratton Fuel Stabilizer, Part No. 5041.)
4. Parts which are scored or broken because an engine was operated with insufficient or contaminated lubricating oil, or an incorrect grade of lubricating oil (check oil level daily or after every 8 hours of operation. Refill when necessary and change at recommended intervals.) OIL GARD® may not shut down running engine. Engine damage may occur if oil level is not properly maintained. Read Operating & Maintenance Instructions.
5. Repair or adjustment of associated parts or assemblies such as clutches, transmissions, remote controls, etc., which are not manufactured by Briggs & Stratton.
6. Damage or wear to parts caused by dirt, which entered the engine because of improper air cleaner maintenance, re-assembly, or use of a non-original air cleaner element or cartridge. (At recommended intervals, clean and re-oil

the Oil-Foam® element or the foam pre-cleaner, and replace the cartridge.) Read Operating & Maintenance Instructions.

7. Parts damaged by over-speeding, or overheating caused by grass, debris, or dirt, which plugs or clogs the cooling fins, or flywheel area, or damage caused by operating the engine in a confined area without sufficient ventilation. (Clean fins on the cylinder, cylinder head and flywheel at recommended intervals.) Read Operating & Maintenance Instructions.
8. Engine or equipment parts broken by excessive vibration caused by a loose engine mounting, loose cutter blades, unbalanced blades or loose or unbalanced impellers, improper attachment of equipment to engine crankshaft, over-speeding or other abuse in operation.
9. A bent or broken crankshaft, caused by striking a solid object with the cutter blade of a rotary lawn mower, or excessive v-belt tightness.
10. Routine tune-up or adjustment of the engine.
11. Engine or engine component failure, i.e., combustion chamber, valves, valve seats, valve guides, or burned starter motor windings, caused by the use of alternate fuels such as, liquified petroleum, natural gas, altered gasolines, etc.

Warranty is available only through service dealers which have been authorized by Briggs & Stratton Corporation. your nearest Authorized Service Dealer is listed in the "Yellow Pages™" of your telephone directory under "Engines, Gasoline" or "Gasoline Engines," "Lawn Mowers," or similar category.

Biggs & Stratton Engines Are Made Under One Or More Of The Following Patents: Design D-247,177 (Other Patents Pending)										
6,691,683	6,520,141	6,325,036	6,145,487	6,012,420	5,803,035	5,548,955	5,243,878	5,138,996	4,875,448	D 476,629
6,647,942	6,495,267	6,311,663	6,142,257	5,992,367	5,765,713	5,546,901	5,235,943	5,086,890	4,819,593	D 457,891
6,622,683	6,494,175	6,284,123	6,135,426	5,904,124	5,732,555	5,445,014	5,234,038	5,070,829	4,720,638	D 368,187
6,615,787	6,472,790	6,263,852	6,116,212	5,894,715	5,645,025	5,503,125	5,228,487	5,058,544	4,719,682	D 375,963
6,617,725	6,460,502	6,260,529	6,105,548	5,887,678	5,642,701	5,501,203	5,197,426	5,040,644	4,633,556	D 309,457
6,603,227	6,456,515	6,242,828	6,347,614	5,852,951	5,628,352	5,497,679	5,197,425	5,009,208	4,630,498	D 372,871
6,595,897	6,382,166	6,239,709	6,082,323	5,843,345	5,619,845	5,320,795	5,197,422	4,996,956	4,522,080	D 361,771
6,595,176	6,369,532	6,237,555	6,077,063	5,823,153	5,606,948	5,301,643	5,191,864	4,977,879	4,520,288	D 356,951
6,584,964	6,356,003	6,230,678	6,064,027	5,819,513	5,606,851	5,271,363	5,188,069	4,977,877	4,512,499	D 309,457
6,557,833	6,349,688	6,213,083	6,040,767	5,813,384	5,605,130	5,269,713	5,186,142	4,971,219	4,453,507	D 308,872
6,542,074	6,347,614	6,202,616	6,014,808	5,809,958	5,497,679	5,265,700	5,150,674	4,895,119	4,430,984	D 308,871

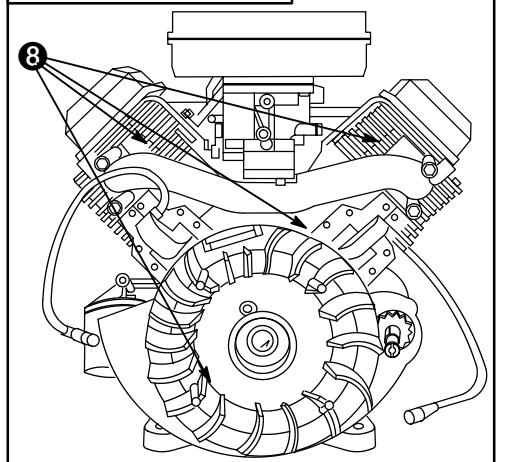
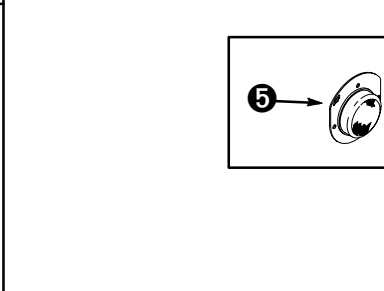
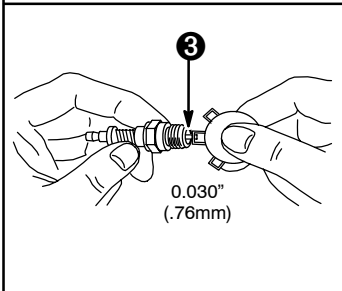
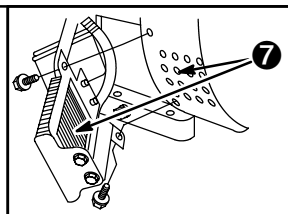
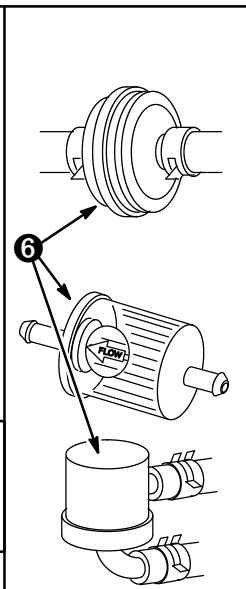
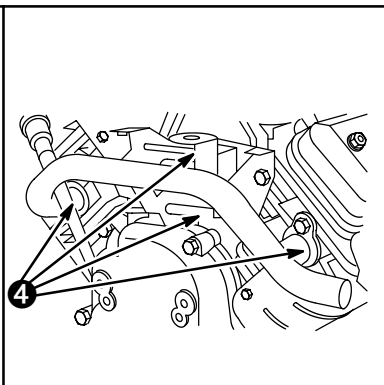
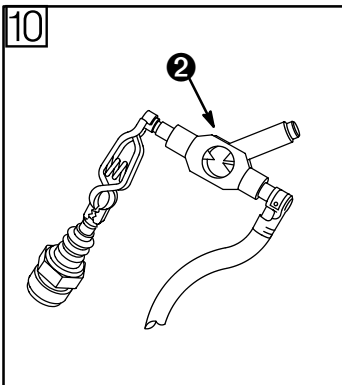
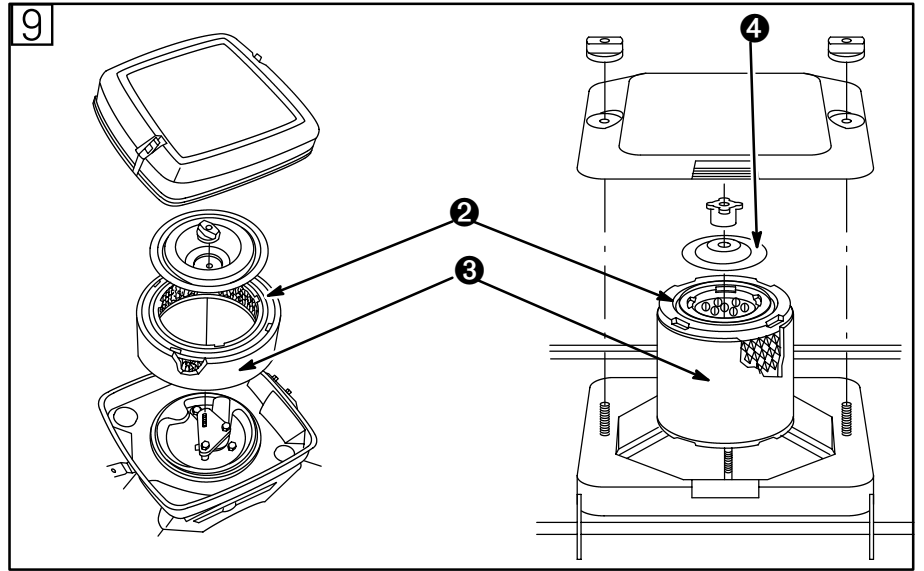
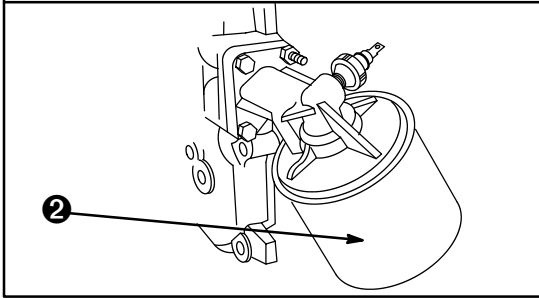
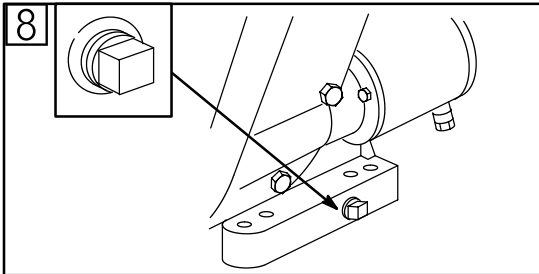
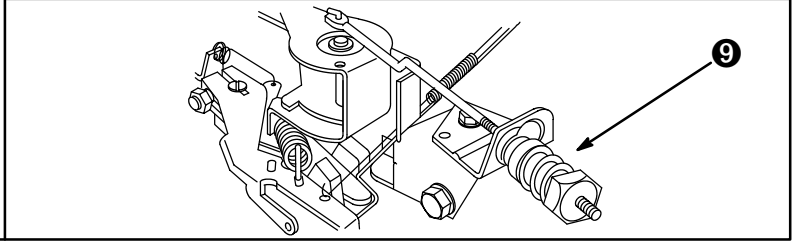
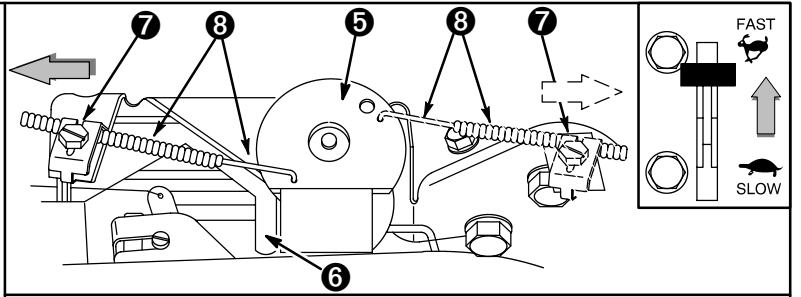
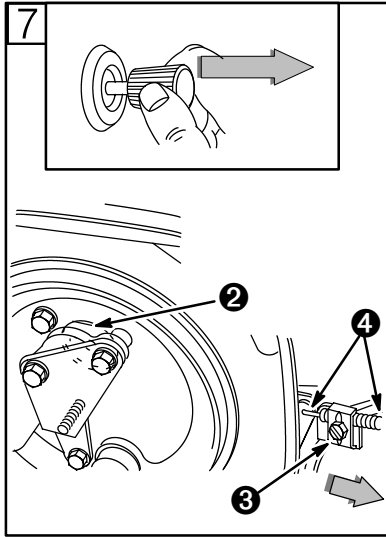
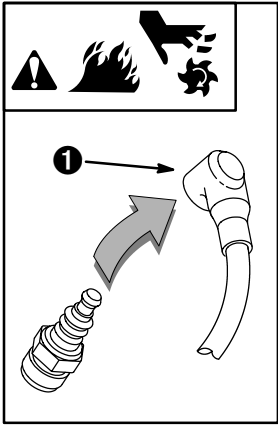

Briggs & Stratton Corporation (B&S), the California Air Resources Board (CARB) and the United States Environmental Protection Agency (U.S. EPA) Emission Control System Warranty Statement (Owner's Defect Warranty Rights and Obligations)

EMISSION CONTROL WARRANTY COVERAGE IS APPLICABLE TO CERTIFIED ENGINES PURCHASED IN CALIFORNIA IN 1995 AND THEREAFTER, WHICH ARE USED IN CALIFORNIA, AND

TO CERTIFIED MODEL YEAR 1997 AND LATER ENGINES WHICH ARE PURCHASED AND USED ELSEWHERE IN THE UNITED STATES (AND AFTER JANUARY 1, 2001 IN CANADA).

California, United States and Canada Emission Control Defects Warranty Statement

The California Air Resources Board (CARB), U.S. EPA and B&S are pleased to explain the Emission Control System Warranty on your model year 2000 and later small off-road engine (SORE). In California, new small off-road engines must be designed, built and equipped to meet the State's stringent anti-smog standards. Elsewhere in the United States, new non-road, spark-ignition engines certified for model year 1997 and later, must meet similar standards set forth by the U.S. EPA. B&S must warrant the emission control system on your engine for the periods of time listed below, provided there has been

no abuse, neglect or improper maintenance of your small off-road engine. Your emission control system includes parts such as the carburetor, air cleaner, ignition system, muffler and catalytic converter. Also included may be connectors and other emission related assemblies.

Where a warrantable condition exists, B&S will repair your small off-road engine at no cost to you including diagnosis, parts and labor.

Briggs & Stratton Emission Control Defects Warranty Coverage

Small off-road engines are warranted relative to emission control parts defects for a period of two years, subject to provisions set forth below. If any covered part on your engine is defective, the part will be repaired or replaced by B&S.

Owner's Warranty Responsibilities

As the small off-road engine owner, you are responsible for the performance of the required maintenance listed in your Operating and Maintenance Instructions. B&S recommends that you retain all your receipts covering maintenance on your small off-road engine, but B&S cannot deny warranty solely for the lack of receipts or for your failure to ensure the performance of all scheduled maintenance.

As the small off-road engine owner, you should however be aware that B&S may deny you warranty coverage if your small off-road engine or a part has failed due to abuse, neglect, improper maintenance or unapproved modifications.

You are responsible for presenting your small off-road engine to an Authorized B&S Service Dealer as soon as a problem exists. The undisputed warranty repairs should be completed in a reasonable amount of time, not to exceed 30 days.

If you have any questions regarding your warranty rights and responsibilities, you should contact a B&S Service Representative at 1-414-259-5262.

The emission warranty is a defects warranty. Defects are judged on normal engine performance. The warranty is not related to an in-use emission test.

Briggs & Stratton Emission Control Defects Warranty Provisions

The following are specific provisions relative to your Emission Control Defects Warranty Coverage. It is in addition to the B&S engine warranty for non-regulated engines found in the Operating and Maintenance Instructions.

1. Warranted Parts

Coverage under this warranty extends only to the parts listed below (the emission control systems parts) to the extent these parts were present on the engine purchased.

- a. Fuel Metering System
 - Cold start enrichment system (soft choke)
 - Carburetor and internal parts
 - Fuel Pump
- b. Air Induction System
 - Air cleaner
 - Intake manifold
- c. Ignition System
 - Spark plug(s)
 - Magneto ignition system
- d. Catalyst System
 - Catalytic converter
 - Exhaust manifold
 - Air injection system or pulse valve
- e. Miscellaneous Items Used in Above Systems
 - Vacuum, temperature, position, time sensitive valves and switches
 - Connectors and assemblies

2. Length of Coverage

B&S warrants to the initial owner and each subsequent purchaser that the Warranted Parts shall be free from defects in materials and workmanship which caused the failure of the Warranted Parts for a period of two years from the date the engine is delivered to a retail purchaser.

3. No Charge

Repair or replacement of any Warranted Part will be performed at no charge to the owner, including diagnostic labor which leads to the determination that a Warranted Part is defective, if the diagnostic work is performed at an Authorized B&S Service Dealer. For emissions warranty service contact your nearest Authorized B&S Service Dealer as listed in the "Yellow Pages" under "Engines, Gasoline," "Gasoline Engines," "Lawn Mowers," or similar category.

4. Claims and Coverage Exclusions

Warranty claims shall be filed in accordance with the provisions of the B&S Engine Warranty Policy. Warranty coverage shall be excluded for failures of Warranted Parts which are not original B&S parts or because of abuse, neglect or improper maintenance as set forth in the B&S Engine Warranty Policy. B&S is not liable to cover failures of Warranted Parts caused by the use of add-on, non-original, or modified parts.

5. Maintenance

Any Warranted Part which is not scheduled for replacement as required maintenance or which is scheduled only for regular inspection to the effect of "repair or replace as necessary" shall be warranted as to defects for the warranty period. Any Warranted Part which is scheduled for replacement as required maintenance shall be warranted as to defects only for the period of time up to the first scheduled replacement for that part. Any replacement part that is equivalent in performance and durability may be used in the performance of any maintenance or repairs. The owner is responsible for the performance of all required maintenance, as defined in the B&S Operating and Maintenance Instructions.

6. Consequential Coverage

Coverage hereunder shall extend to the failure of any engine components caused by the failure of any Warranted Part still under warranty.

Look For Relevant Emission Durability Period and Air Index Information On Your Engine Emission Label

Engines that are certified to meet the California Air Resources Board (CARB) Tier 2 Emission Standards must display information regarding the Emissions Durability Period and the Air Index. Briggs & Stratton makes this information available to the consumer on our emission labels. The engine label will indicate certification information.

The **Emission Durability Period** describes the number of hours of actual running time for which the engine is certified to be emission compliant, assuming proper maintenance in accordance with the Operating & Maintenance Instructions. The following categories are used:

Moderate: Engine is certified to be emission compliant for 125 hours of actual engine running time.

Intermediate: Engine is certified to be emission compliant for 250 hours of actual engine running time.

Extended: Engine is certified to be emission compliant for 500 hours of actual engine running time.

For example, a typical walk-behind lawn mower is used 20 to 25 hours per year. Therefore, the **Emission Durability Period** of an engine with an **intermediate** rating would equate to 10 to 12 years.

The **Air Index** is a calculated number describing the relative level of emission for a specific engine family. The lower the **Air Index**, the cleaner the engine. This information is displayed in graphical form on the emission label.

After July 1, 2000, Look For Emissions Compliance Period On Engine Emissions Compliance Label

After July 1, 2000 certain Briggs & Stratton engines will be certified to meet the United States Environmental Protection Agency (USEPA) Phase 2 emission standards. For Phase 2 certified engines, the Emissions Compliance Period referred to on the Emissions Compliance label indicates the number of operating hours for which the engine has been shown to meet Federal emission requirements. For engines less than 225 cc displacement, Category C = 125 hours, B = 250 hours and A = 500 hours. For engines of 225 cc or more, Category C = 250 hours, B = 500 hours and A = 1000 hours.

The displacement of Model Series 290000 and 300000 engines is 480 cc. The displacement of Model Series 350000 engines is 570 cc. The displacement of Model Series 380000 engines is 627 cc.

This is a generic representation of the emission label typically found on a certified engine.

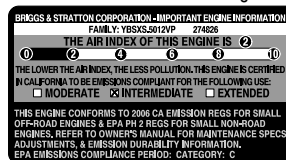

La Corporation Briggs & Stratton (B&S), le California Air Resources Board (CARB) et le Bureau de protection environnementale des Etats-Unis (US EPA)

Garantie sur le système d'échappement (Garantie contre les défectuosités, droits et obligations du propriétaire)

LA GARANTIE SUR LE SYSTÈME D'ÉCHAPPEMENT EST APPLICABLE SUR LES MOTEURS CERTIFIÉS ACHETÉS EN CALIFORNIE EN 1995 ET LES ANNÉES SUIVANTES ET QUI SONT UTI-

LISES EN CALIFORNIE, AINSI QU'ÀUX MODELES CERTIFIÉS DE 1997 ET LES ANNÉES SUIVANTES QUI ONT ÉTÉ ACHETÉS ET UTILISÉS AILLEURS AUX ETATS-UNIS ET AU CANADA.

Déclaration de garantie sur le système d'échappement pour la Californie, les Etats-Unis et le Canada

Le California Air Resources Board (CARB), le Bureau américain de protection environnementale (U.S. EPA) et B & S sont heureux d'expliquer la garantie sur le système d'échappement des petits moteurs hors-route de votre modèle 2000 et des années ultérieures (SORE). En Californie, les nouveaux petits moteurs hors route doivent être conçus, construits et équipés pour rencontrer les standards rigoureux d'antipollution. Ailleurs aux Etats-Unis, les nouveaux moteurs hors route à bougie d'allumage certifiés pour les modèles de 1997 et plus, doivent rencontrer des normes similaires mises de l'avant par le U.S. EPA. Briggs & Stratton garantit le système de contrôle d'échap-

pement de votre moteur pour la période de temps mentionnée ci-contre, sauf s'il a fait l'objet d'abus, de négligence ou d'un entretien inapproprié. Votre système de contrôle d'échappement comprend des pièces telles que le carburateur, le filtre à air, le système d'ignition, le silencieux et le convertisseur catalytique. Il peut aussi comprendre les connecteurs et autres pièces reliées à l'émission.

Lorsqu'il y a condition à garantie, B&S réparera gratuitement votre petit moteur hors-route incluant le diagnostic, les pièces et la main d'œuvre.

Couverture de garantie Briggs & Stratton contre toute défectuosité du système de contrôle d'échappement

Les petits moteurs hors route sont garantis contre la défectuosité des pièces du système de contrôle d'échappement pour une période de 2 ans, sujette aux conditions stipulées ci-contre. Si n'import-

te quelle pièce de votre moteur couverte par cette garantie est défectueuse, elle sera réparée ou remplacée par B&S.

Responsabilités du propriétaire

En tant que propriétaire d'un petit moteur hors route, vous êtes responsable de veiller à l'exécution de l'entretien requis tel que stipulé dans votre manuel d'opération et d'entretien. B&S vous recommande de conserver tous les reçus couvrant les travaux d'entretien de votre petit moteur hors route, mais B&S ne peut refuser la garantie en raison d'absence de reçus ou pour défaut d'avoir suivi tout l'échéancier du programme d'entretien.

Vous avez la responsabilité d'apporter votre petit moteur hors route à un détaillant autorisé B&S aussitôt que survient un problème. Les réparations sous garantie doivent être complétées dans un délai raisonnable ne devant pas excéder 30 jours.

Si vous avez des questions relativement à votre garantie, vos droits et responsabilités, veuillez communiquer avec un représentant de service B&S au numéro 1-414-259-5262.

La garantie du système d'échappement est une garantie contre les défectuosités. Les défectuosités sont jugées en fonction d'une utilisation normale du moteur. La garantie n'est pas reliée à un test d'échappement effectué à l'intérieur.

Dispositions de la garantie du système d'échappement Briggs & Stratton

Ce qui suit concerne les dispositions spécifiques relativement à votre garantie sur le système de contrôle d'échappement. C'est une addition à la garantie B&S pour les moteurs non réglementés contenue dans le manuel d'entretien et d'utilisation.

1. Pièces sous garantie

La couverture de cette garantie ne s'applique que sur les pièces listées ci-contre (les parties du système de contrôle d'échappement) dans la mesure où ces pièces étaient présentes sur le moteur au moment de l'achat.

- a. Système de dosage du carburant
 - Système d'enrichissement de démarrage à froid
 - Carburateur et parties internes
 - Pompe à essence
- b. Système d'induction d'air
 - Filtre à air
 - Tubulure d'admission
- c. Système d'ignition
 - Bougies d'allumage
 - Système d'allumage électromagnétique
- d. Système catalyseur
 - Convertisseur catalytique
 - Collecteur d'échappement
 - Système d'injection d'air ou à pulsion
- e. Autres pièces utilisées dans les systèmes ci-haut mentionnés
 - Soupapes et interrupteurs de dépression, de température, de position.
 - Connecteurs et assemblages.

2. Durée de la couverture

B&S garantit le propriétaire initial et tous les acheteurs subséquents que les pièces sous garantie sont exemptes de vice de matière ou de fabrication qui pourraient causer des défectuosités des pièces sous garantie pour une période de deux ans à partir de la date à laquelle le moteur a été livré à l'acheteur.

3. Aucuns Frais

La réparation ou le remplacement de toute pièce sous garantie sera effectuée sans aucuns frais pour le propriétaire, incluant les frais de main d'œuvre pour le diagnostic afin de déterminer si la pièce sous garantie est défectueuse, conditionnel à ce que le diagnostic soit effectué chez un détaillant autorisé B&S. Pour la garantie relative au système d'échappement, communiquez avec le détaillant autorisé B&S le plus proche tel que listé dans les pages jaunes de votre localité sous la rubrique moteur à essence, tondeuse ou autre catégorie similaire.

4. Réclamations et exclusions de la couverture.

Les réclamations de garantie doivent être complétées en accord avec les dispositions de la politique de garantie B&S. La garantie ne couvre pas les défectuosités de pièces qui ne sont pas des pièces d'origine B&S ou dans le cas d'abus, négligence ou d'un entretien inapproprié. La garantie B&S ne couvre pas les défectuosités de pièces sous garantie qui ont fait l'objet d'ajouts, ont été modifiées ou de pièces qui ne sont pas des pièces B&S d'origine.

5. Entretien

Toute pièce sous garantie qui n'est pas remplacée au moment requis selon le manuel d'entretien ou qui est planifiée seulement pour une inspection régulière sous la mention « réparer ou remplacer si nécessaire » est garantie contre toute défectuosité pour la période de garantie. Toute pièce sous garantie qui est planifiée pour un remplacement tel que requis dans l'entretien est garantie contre toute défectuosité seulement pour la période de temps qui va jusqu'au premier remplacement prévu pour cette pièce. Toute pièce de remplacement équivalente en performance et durabilité peut être utilisée pour l'entretien ou la réparation. Le propriétaire est responsable de l'exécution de tout entretien requis tel que défini dans le manuel d'instruction B&S sur l'entretien et la réparation.

6. Couverture indirecte

La couverture ci-contre s'étend à toute défectuosité des composantes du moteur causée par la défectuosité de n'importe quelle pièce couverte par la garantie et dont la garantie est encore en vigueur.

Consultez les informations sur la période de durabilité d'émission et l'INDICE d'air sur l'étiquette d'émission de votre moteur

Les moteurs qui sont certifiés conformes aux normes standards d'émission du California Air Resources Board (CARB) Tier 2, doivent afficher l'information concernant la période de durabilité du système d'émission et l'INDICE d'air. Cette information est indiquée sur les étiquettes apposées sur les moteurs par Briggs & Stratton. L'étiquette du moteur indiquera les renseignements concernant la certification. La **période de durabilité d'émission** indique le nombre d'heures d'utilisation normale pour lequel le moteur est certifié conforme aux normes d'émission sous réserve d'un entretien approprié tel qu'indiqué dans le manuel d'opération et d'entretien. Les catégories suivantes sont utilisées :

Modéré le moteur est certifié conforme pour 125 heures d'utilisation normale.

Intermédiaire le moteur est certifié conforme pour 250 heures d'utilisation normale.

Prolongé le moteur est certifié conforme pour 500 heures d'utilisation normale.

Par exemple, une tondeuse de modèle standard est utilisée environ 20 à 25 heures par année. Par conséquent, la **période de durabilité d'émission** d'un moteur dans la catégorie intermédiaire pour ce type de tondeuse équivaut à 10 à 12 ans.

L'**indice d'air** est un nombre qui décrit le niveau relatif d'émission pour une catégorie spécifique de moteur. Plus l'**indice d'air** est bas, plus le moteur est écologique. Cette information est indiquée sous une forme graphique sur l'étiquette d'émission.

A compter du 1^{er} juillet 2000, surveillez la période de conformité d'émission sur les étiquettes

Après le 1^{er} juillet 2000, certains moteurs B&S seront certifiés conformes aux normes environnementales d'émission standard du United States Environmental Protection Agency (US EPA) Phase 2. Pour les moteurs certifiés pour la Phase 2, la période de conformité d'émission mentionnée sur les étiquettes indique le nombre d'heures d'utilisation pour lequel le moteur rencontre les normes fédérales. Pour les moteurs de force moindre que 225 cc, la catégorie C = 125 heures, B = 250 heures et A = 500 heures. Pour les moteurs de 225 cc et plus, la catégorie C = 250 heures, B = 500 heures et A = 1000 heures. Le remplacement du moteur portant le modèle de série 290000 et 300000 est 480 cc. Le remplacement du moteur portant le modèle de série 350000 est 570 cc. Le remplacement du moteur portant le modèle de série 380000 est 627 cc.

Ceci est une représentation des étiquettes d'émission que vous retrouverez sur les moteurs certifiés :

