



Parts Manual

Mfg. No: 289707-1179-E2





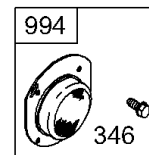
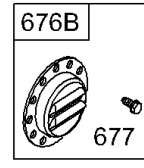
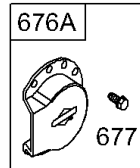
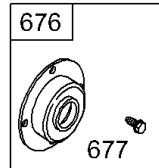
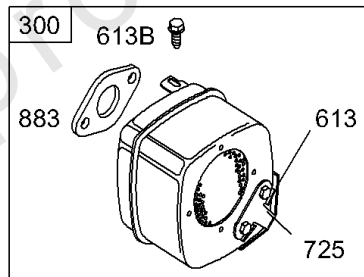
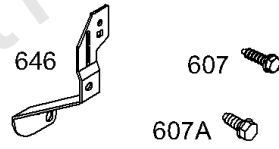
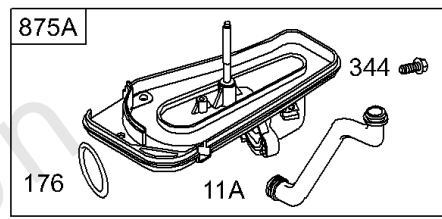
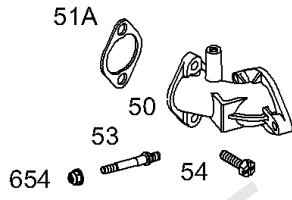
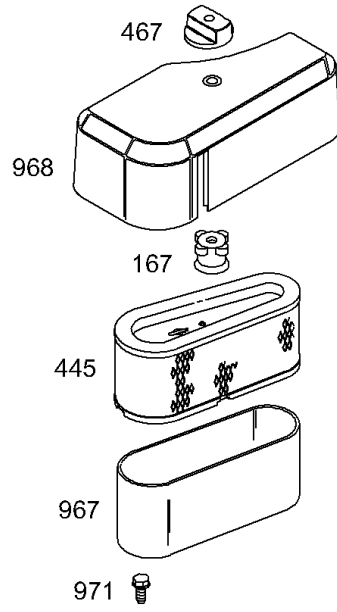





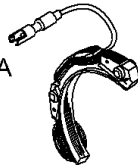

Model Components	Page
Air Cleaner, Muffler, Spark Arrestor.....	4
Alternator, Wires, Armature.....	6
Blower Housings, Rotating Screen, Shroud.....	8
Carburetors, Gasket Sets.....	12
Controls, Springs, Fuel, Links.....	16
Cylinder, Oil, Crankshaft, Sump, Cam, Piston, Gaskets.....	20
Electric Starters.....	26
Flywheel, Rewind Starter.....	30
Replacement Engine - US & Canada.....	34

Not For
Reproduction

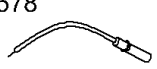

Air Cleaner, Muffler, Spark Arrestor

REF NO	PART NO	QTY	DESCRIPTION
11A	691328		TUBE, Breather
50	691711		MANIFOLD, Intake
51A	272554S		GASKET, Intake
53	690227		STUD -(Carburetor)
54	690953		SCREW -(Intake Manifold)
167	692297		SEAL-A/C NUT
176	691917		SEAL, O-Ring -(Air Cleaner Base)
300	691874		MUFFLER
344	693675		SCREW -(Cable Clamp) (Air Cleaner Base)
346	690661		SCREW -(Spark Arrestor)
445	496894S		FILTER-A/C CARTRIDGE
467	691668		KNOB, Air Cleaner Cover
607	690703		SCREW -(Air Cleaner Brace)
607A	691693		SCREW -(Air Cleaner Brace)
613	691416		SCREW -(Muffler)
613B	692198		SCREW -(Muffler)
646	690460		BRACE, Air Cleanr
654	690958		NUT -(Carburetor)
676	396903		DEFLECTOR, Muffler
676A	393761		DEFLECTOR, Muffler -(Side Outlet)
676B	397630		DEFLECTOR, Muffler -(Louvered Outlet)
677	690661		SCREW -(Muffler Deflector)
725	690403		SHIELD, Heat
875A	696129		BASE, Air Cleaner -(Plastic)
883	692236		GASKET, Exhaust
967	272403S		FILTER-PRE CLEANER
968	691916		COVER, Air Cleaner
971	691108		SCREW -(Air Cleaner Base) (Remote Choke)
994	392390		ARRESTOR, Spark

DC ONLY	DUAL CIRCUIT	TRI CIRCUIT	10/16 AMP
<p>474</p>  <p>877A</p>	<p>474A</p>  <p>877</p>	<p>474B</p>  <p>877B</p>	<p>474C</p>  <p>877C</p>
<p>1059</p> 	<p>1059</p> 	<p>1059</p> 	<p>1059</p> 
<p>578</p> 	<p>878</p> 	<p>878A</p> 	<p>578</p> 

NOTE: All Stators use Reference 1119 Mounting Screw.

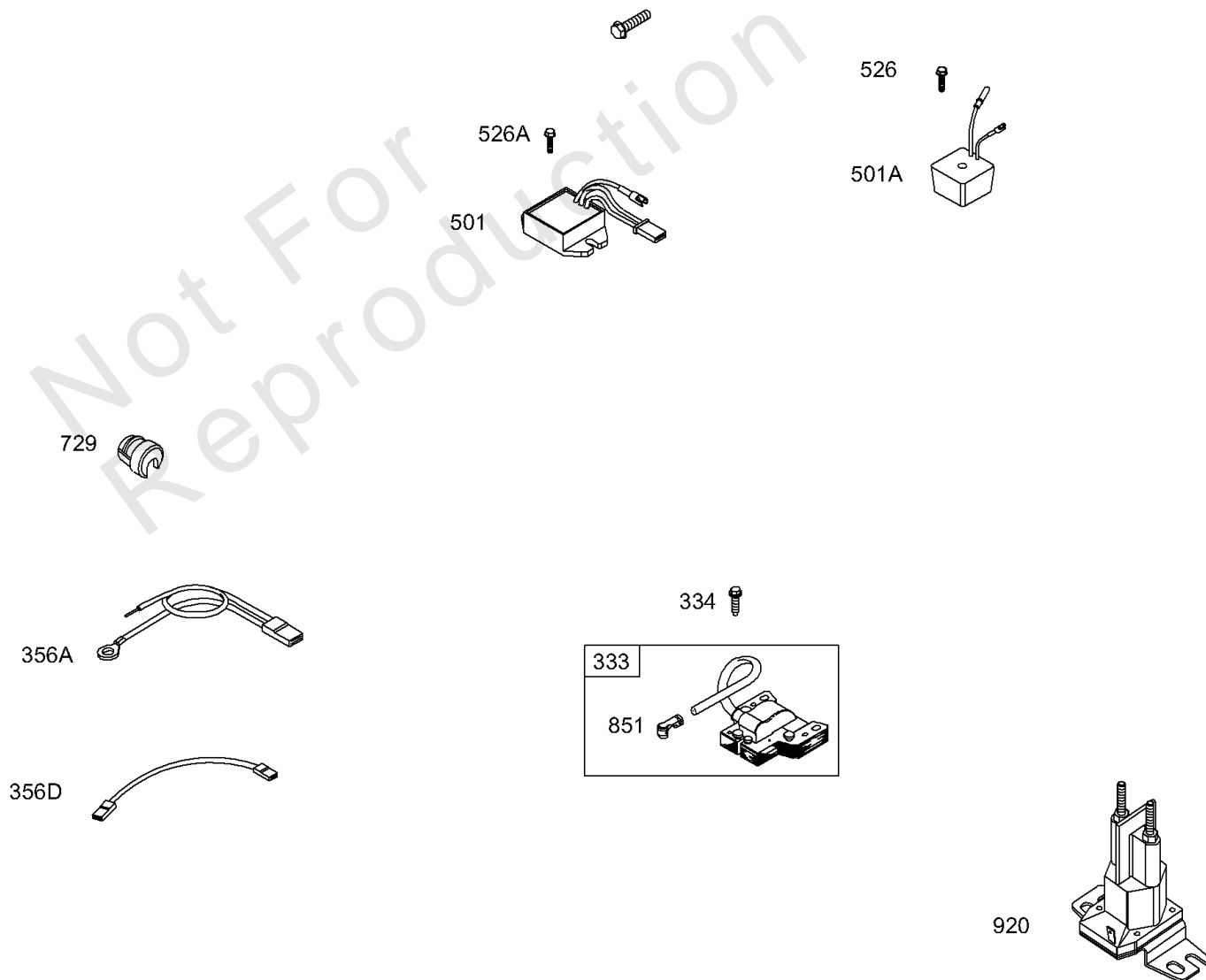

Alternator, Wires, Armature

REF NO	PART NO	QTY	DESCRIPTION
333	492341		ARMATURE, Magneto
334	691061		SCREW -(Magneto Armature)
356A	398808		WIRE, Stop -(Cut To Required Length)
356D	690799		WIRE, Stop
474	696578		ALTERNATOR -(DC Only)
474A	696459		ALTERNATOR -(Dual Circuit)
474B	696457		ALTERNATOR -(Tri Circuit)
474C	696458		ALTERNATOR -(10/16 AMP)
501	691185		REGULATOR -(16 Amp Regulated)
501A	691188		REGULATOR -(9 Amp Regulated)
526	690326		SCREW -(Regulator) (1 1/4" Long)
526A	692198		SCREW -(Regulator) (1 7/16)
578	692306		WIRE ASSEMBLY -(1 Wire, 48-1/2" Long)(Snap Connect Female Pin Socket, And Bare WireEnd)
729	690596		CLIP, Wire
851	493880S		TERMINAL-SPARK PLUG
877	393456		WIRE/CONNECTOR, Alternator
877A	393814		WIRE/CONNECTOR, Alternator -(10 Amp Regulated)
877B	393537		WIRE/CONNECTOR, Alternator -(Tri Circuit) (9 Amp)
877C	399916		WIRE/CONN-ALTERNATOR
878	691237		HARNESS, Alternator
878A	691955		HARNESS, Alternator
920	691656		SOLENOID, Starter
1059	698516		KIT, Screw/Washer -(Alternator)
1119	691183		SCREW -(Alternator)

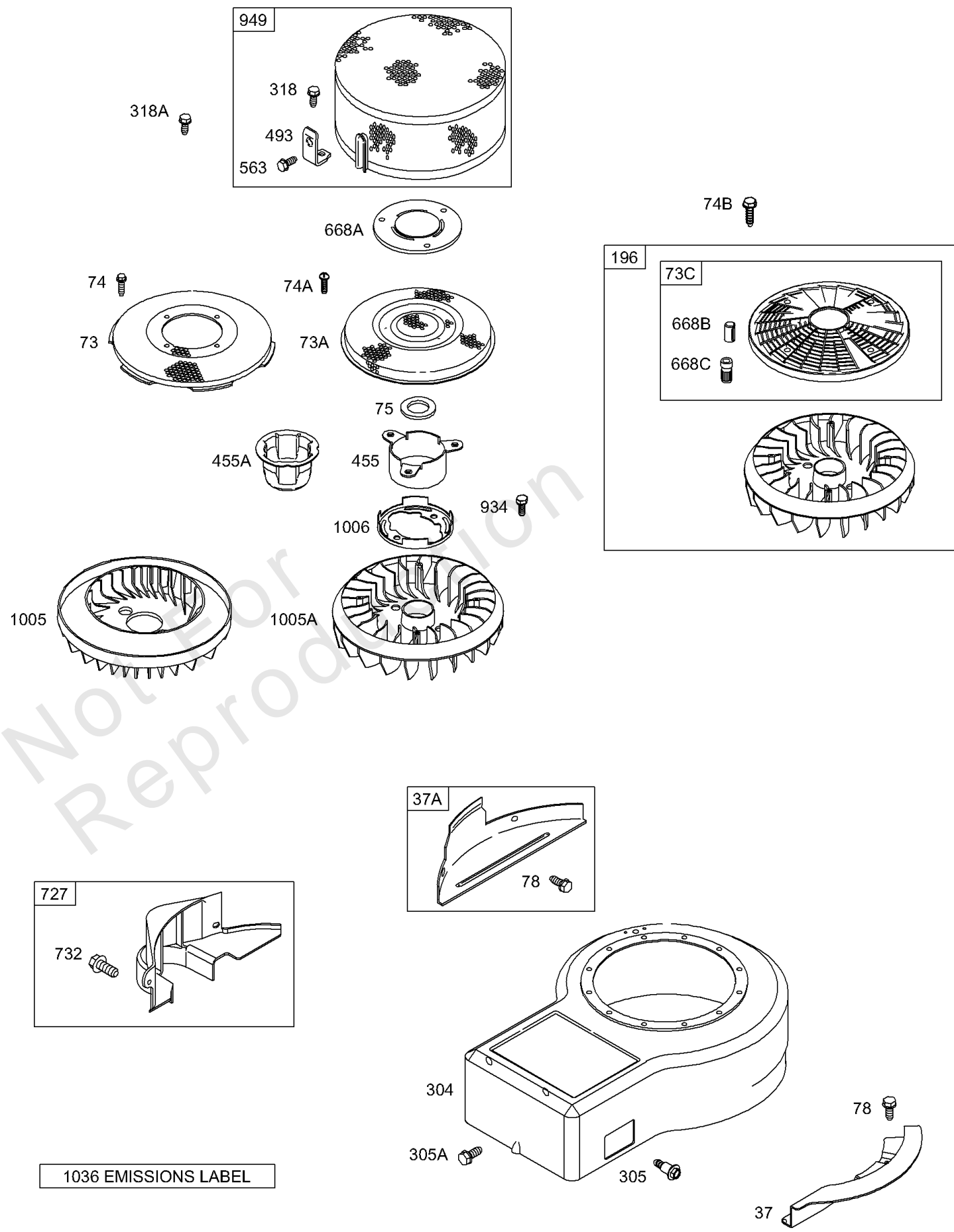

Blower Housings, Rotating Screen, Shroud

REF NO	PART NO	QTY	DESCRIPTION
37	690456		GUARD, Flywheel
37A	690806		GUARD-FLYWHEEL
73	691191		SCREEN-ROTATING
73A	691748		SCREEN-ROTATING
73C	494439		SCREEN, Rotating
74	691655		SCREW -(Rotating Screen)
74A	691627		SCREW -(Rotating Screen)
74B	691674		SCREW -(Rotating Screen) (1 1/2)
74B	698425		SCREW -(Rotating Screen) (1 1/4" Long)
75	690582		WASHER -(Flywheel)
78	690661		SCREW -(Flywheel Guard)
304	494268		HOUSING, Blower -(Red) -Used Before Code Date 93071900
304	690846		HOUSING, Blower -Used After Code Date 93071800
305	692127		SCREW -(Blower Housing)
305A	692198		SCREW -(Blower Housing)
318	694476		SCREW -(Mounting Bracket) (Debris Screen Guard)
318A	691617		SCREW -(Mounting Bracket) (Debris Screen Guard)
455	691173		CUP, Flywheel
455A	695113		CUP, Flywheel
493	692825		BRACKET-MOUNTING
563	690859		SCREW -(Debris Screen Guard)
668A	691323		SPACER
668B	691215		SPACER -(FAN/SCREEN ASSEMBLY)
668C	691500		SPACER -(FAN/SCREEN ASSEMBLY)
727	490324		COVER, Starter Drive -(Includes Mounting Hardware)
732	691002		SCREW -(Starter Drive Cover)
934	691058		SCREW -(Fan Retainer)
949	397530		GUARD, Debris Screen -(Rewind Starter)
1005	691905		FAN, Flywheel -Used Before Code Date 99102500
1005A	695056		FAN, Flywheel -Used After Code Date 99102400
1006	690452		RETAINER, Fan
1036	499361		LABEL, Emissions -Used Before Code Date 97070100
1036	696770		LABEL, Emissions -Used After Code Date 01093000

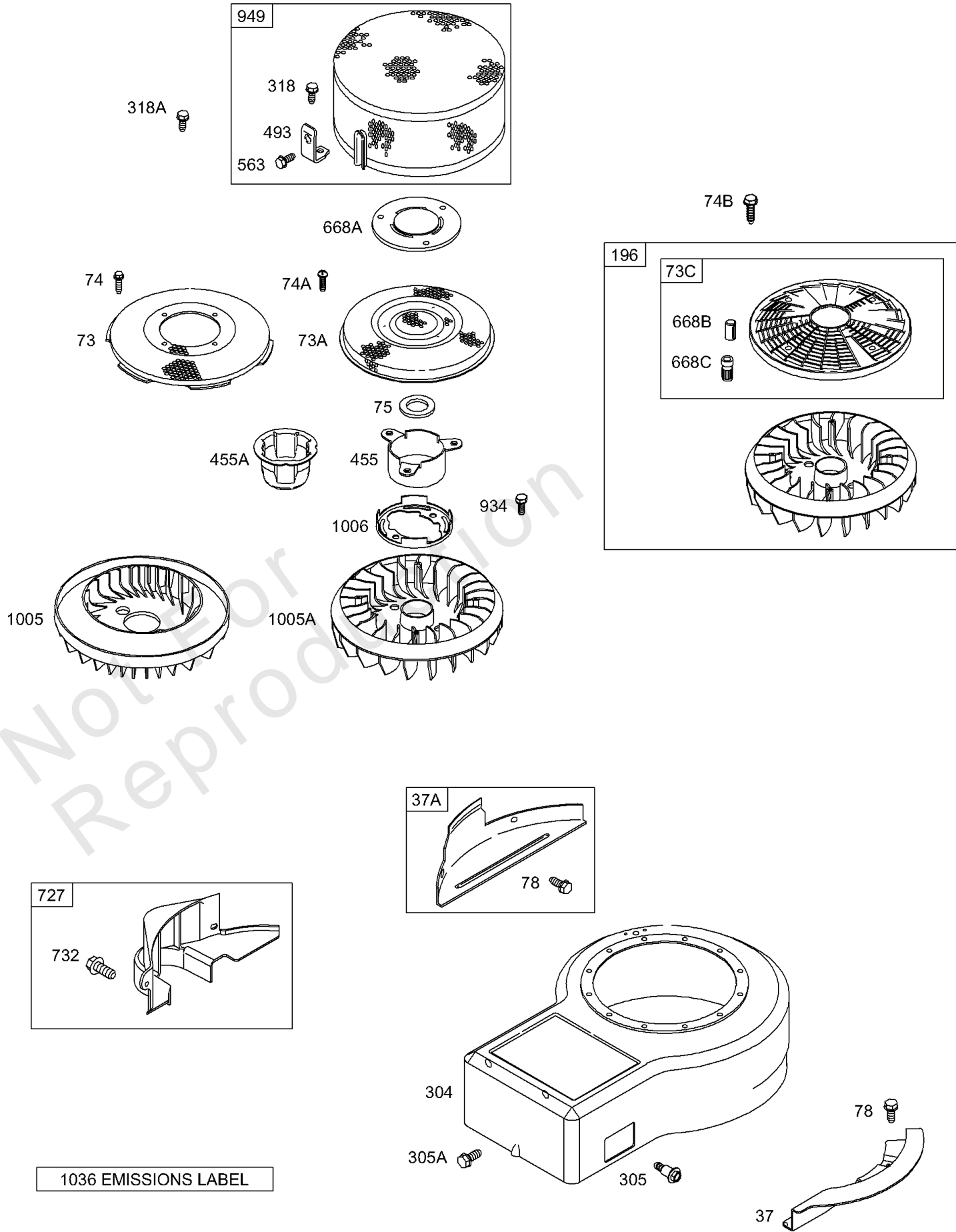

Blower Housings, Rotating Screen, Shroud

REF NO	PART NO	QTY	DESCRIPTION
1036	695036		LABEL, Emissions -Used After Code Date 99093000 -Used Before Code Date 00070300
1036	695699		LABEL, Emissions -Used After Code Date 00070200 -Used Before Code Date 01100100
1036	694325		LABEL, Emissions -Used After Code Date 99103000 -Used Before Code Date 99100100
1036	499362		LABEL, Emissions -Used After Code Date 97063000 -Used Before Code Date 99010400

Not For Reproduction

NIKKI

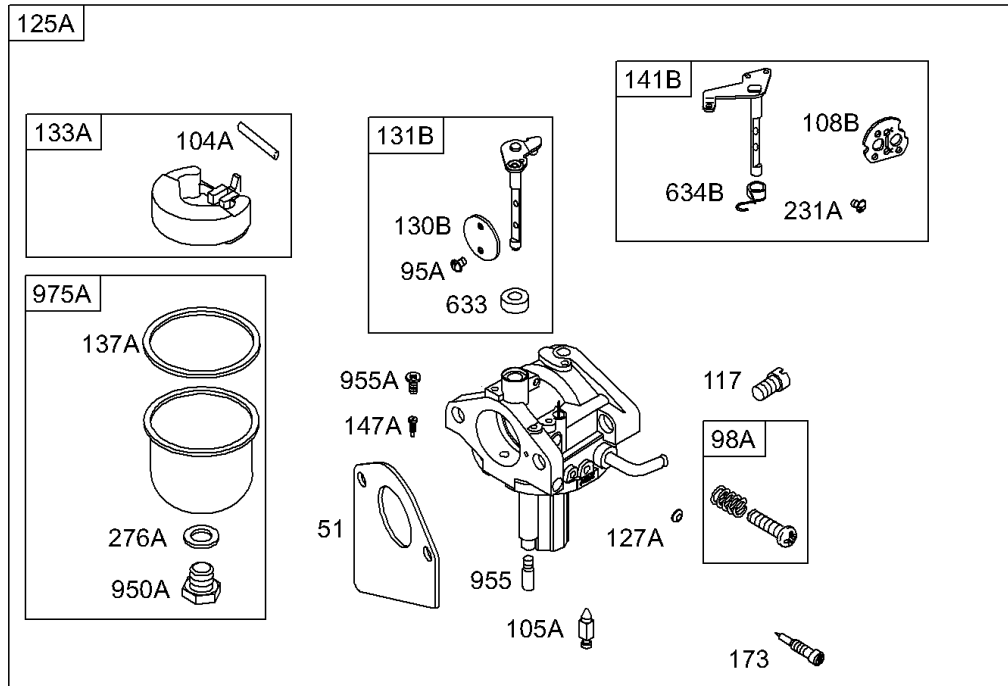

WALBRO

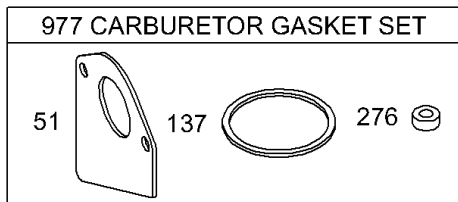
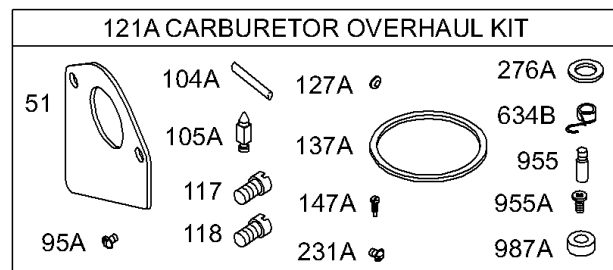
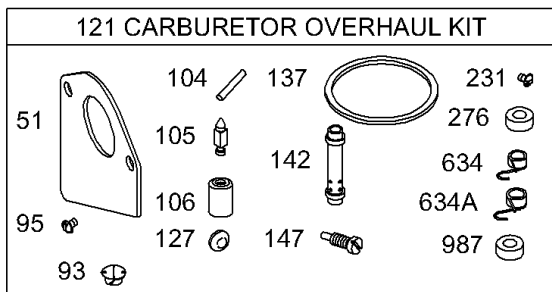
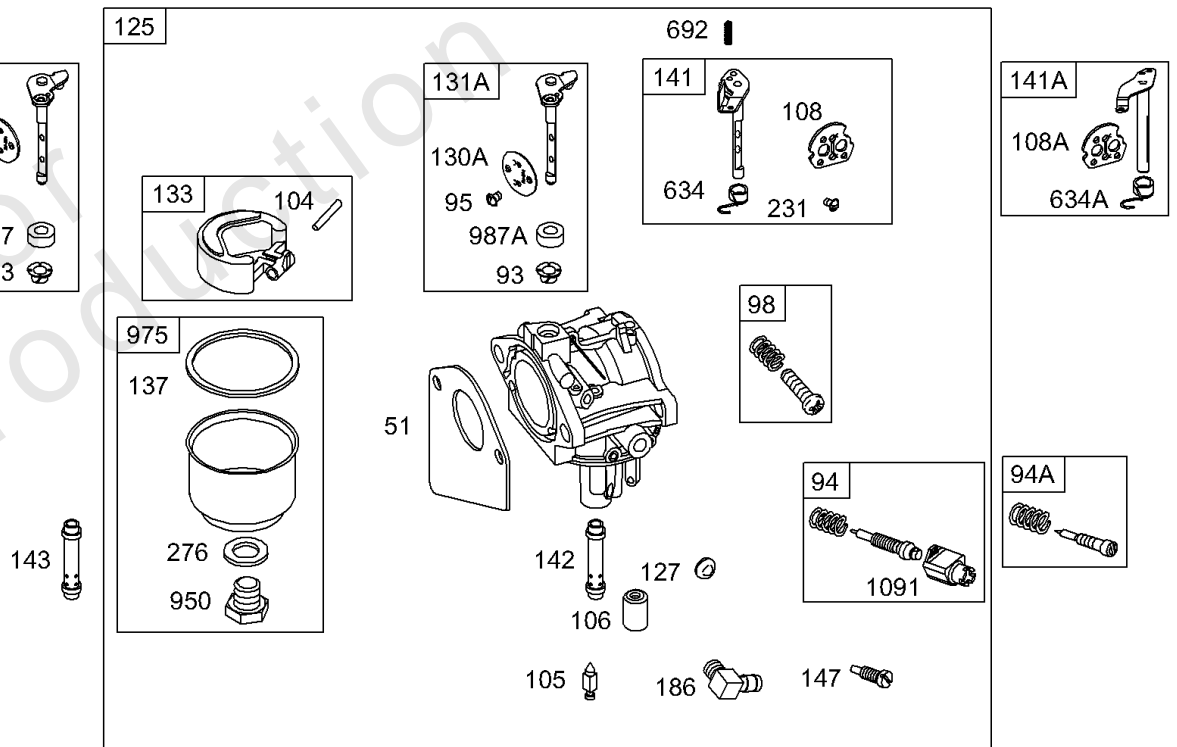

WALBRO

NIKKI

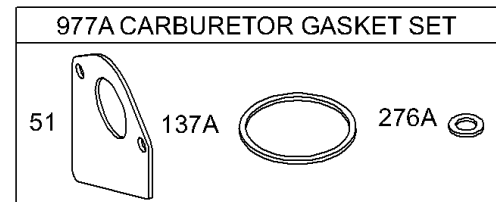

Carburetors, Gasket Sets

REF NO	PART NO	QTY	DESCRIPTION
51	692284		GASKET, Intake
93	690602		BUSHING, Throttle Shaft
94	498030		KIT, Idle Mixture -(Lmt 153154,155,156)
94A	494383		KIT, Idle Mixture -(Lmt 71,101,102,113,114,116)
95	691636		SCREW -(Throttle Valve)
95A	690718		SCREW -(Throttle Valve)
98	495800		KIT, Idle Speed -(Idle Speed) (Lmt 54, 55, 91)
98A	694907		KIT, Idle Speed
104	690525		PIN, Float Hinge
104A	694918		PIN, Float Hinge
105	231855S		VALVE-FLOAT NEEDLE
105A	694922		VALVE, Float Needle
106	690577		SEAT, Inlet
106	691780		SEAT, Inlet -(LMT 5, 6)
108	690464		VALVE, Choke
108A	692344		VALVE, Choke
108B	694923		VALVE, Choke
117	690880		JET, Main -(Standard)
118	694925		JET, Main -(High Altitude)
121	497535		KIT, Carburetor Overhaul -(LMT 5, 37, 77)
121	499220		KIT, Carburetor Overhaul -(LMT 92, 93, 94, 95, 96, 108, 111, 162, 165, 169)
121	499231		KIT, Carburetor Overhaul -(LMT 97, 99, 133, 135, 136, 157, 158, 159, 160, 166, 168)
121	697884		KIT, Carburetor Overhaul -(696160, 696162, 696164, 696166, 697212, 697213, 697214, 697906)
121	497481		KIT, Carburetor Overhaul -(LMT 63, 65, 66)
121A	694930		KIT, Carburetor Overhaul -(Nikki Carburetor)
125	698171		CARBURETOR -(696160, 696162, 696164, 696166, 697212, 697213, 697214, 697906)
125	498027		CARBURETOR -(LMT 37, 77, 78, 79, 80, 81, 92, 93, 94, 96, 97, 99, 100, 108, 109, 110,111, 133, 134, 135, 136, 157, 158, 159, 162, 165, 166, 167, 168, 169)(Gravity Feed)
125	499158		CARBURETOR -(LMT 162, 165, 166, 167, 168, 169)
125A	694941		CARBURETOR -(Nikki Carburetor)
127	695005		PLUG, Welch
127A	694916		PLUG, Welch
130	690468		VALVE, Throttle
130A	694917		VALVE, Throttle
130B	691750		VALVE, Throttle
131	494885		KIT, Throttle Shaft -(LMT 111, 169)
131A	494379		KIT, Throttle Shaft
131B	694909		KIT, Throttle Shaft

NIKKI

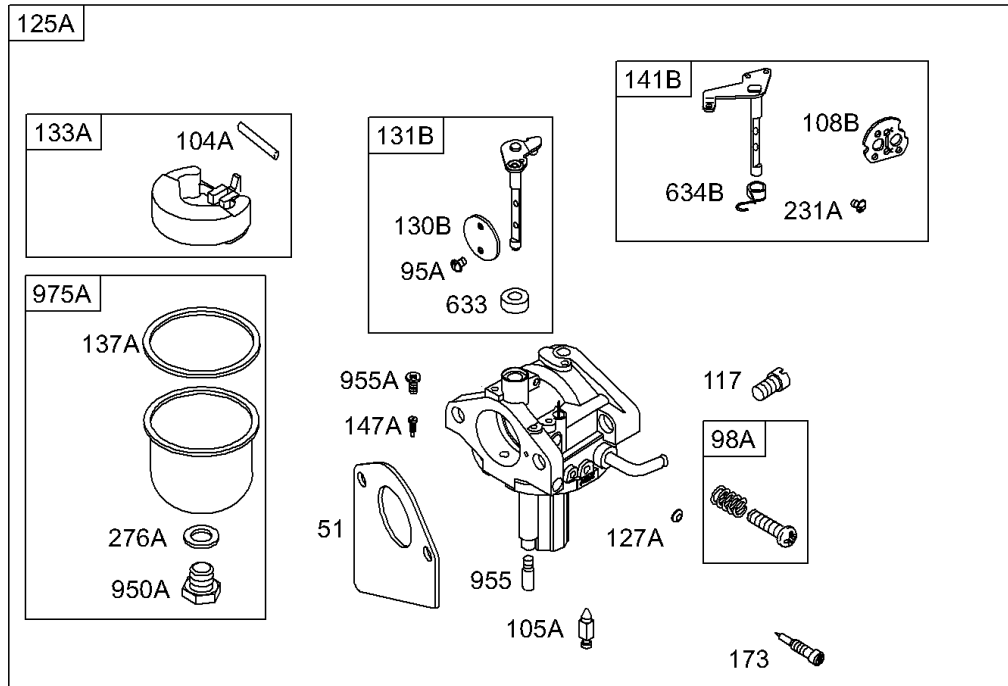

WALBRO

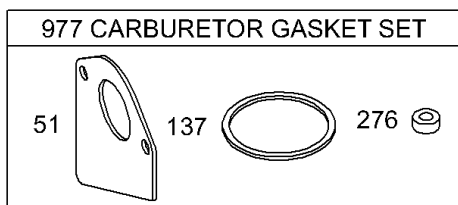
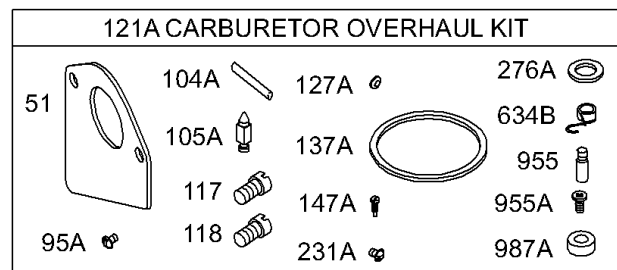
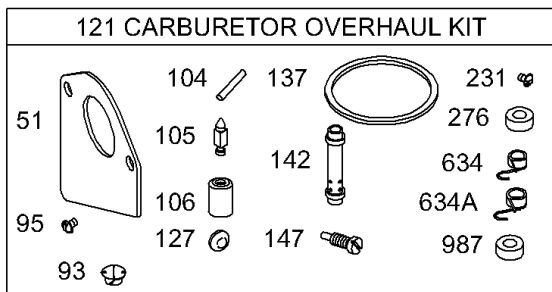
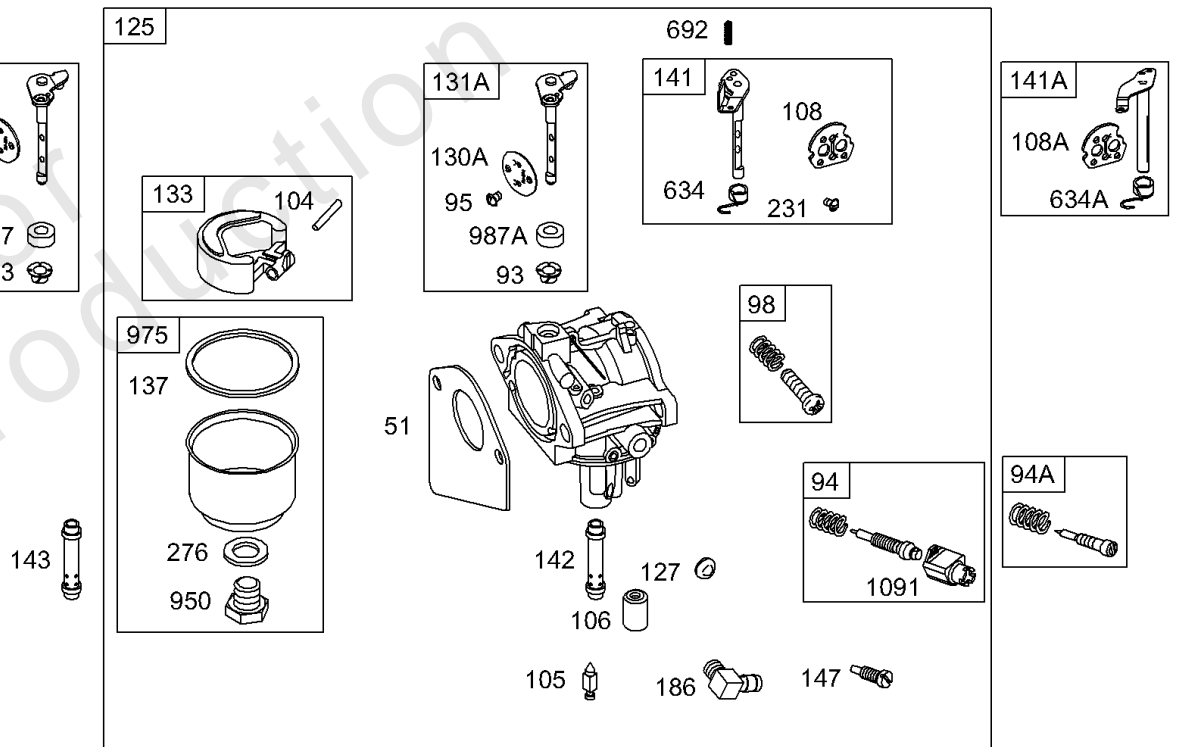

WALBRO

NIKKI

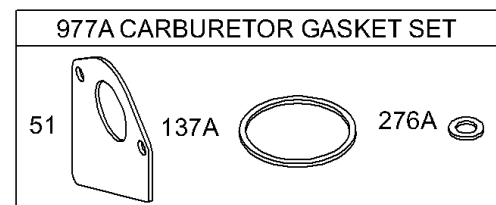

Carburetors, Gasket Sets

REF NO	PART NO	QTY	DESCRIPTION
133	494381		FLOAT, Carburetor
133A	694914		FLOAT, Carburetor
134	494788		KIT, Needle/Seat -(LMT 5, 6)
137	281165S		GASKET, Float Bowl
137A	694920		GASKET, Float Bowl
141	495097		KIT, Choke Shaft -(Manual Choke)
141A	495931		KIT, Choke Shaft -(Choke A Matic)
141B	694913		KIT, Choke Shaft
142	691434		NOZZLE, Carburetor -(Standard) (LMT 92, 96)(Gravity Feed)
142	691425		NOZZLE, Carburetor -(Standard) (LMT 5, 6, 37, 41, 77, 81, 157)
143	497737		NOZZLE, Carburetor -(High Altitude) (LMT 5, 6, 37, 41, 77, 81, 157)
143	497567		NOZZLE, Carburetor -(High Altitude) (LMT 5, 6, 37, 41, 77, 81, 157)
147	497472		JET, Pilot -(LMT 37, 41, 77, 81)
147A	694927		JET, Pilot
173	694926		VALVE, Idle Mixture
186	692317		CONNECTOR-HOSE
231	691636		SCREW -(Choke Valve)
231A	690718		SCREW -(Choke Valve)
276	692255		WASHER, Sealing
276A	690997		WASHER, Sealing
633	690998		SEAL, Choke/Throttle Shaft
634	690801		SPRING/SEAL ASSEMBLY
634A	690802		SPRING/SEAL ASSEMBLY
634B	694912		SPRING/SEAL ASSEMBLY
692	690572		SPRING, Detent
950	691657		SCREW -(Float Bowl)
950A	694919		SCREW -(Float Bowl)
955	694924		PLUG, Carburetor -(Idle Chamber)
955A	694921		PLUG, Carburetor -(Pilot Jet)
975	495933		BOWL, Float -(Float Bowl)
975A	694908		BOWL, Float
977	690192		SET, Carburetor Gasket
977A	694931		SET, Carburetor Gasket -(Nikki Carburetor)
987	691326		SEAL, Choke/Throttle Shaft
987A	692001		SEAL, Choke/Throttle Shaft -(LMT 5, 6, 37, 41)
1091	691333		CAP, Limiter

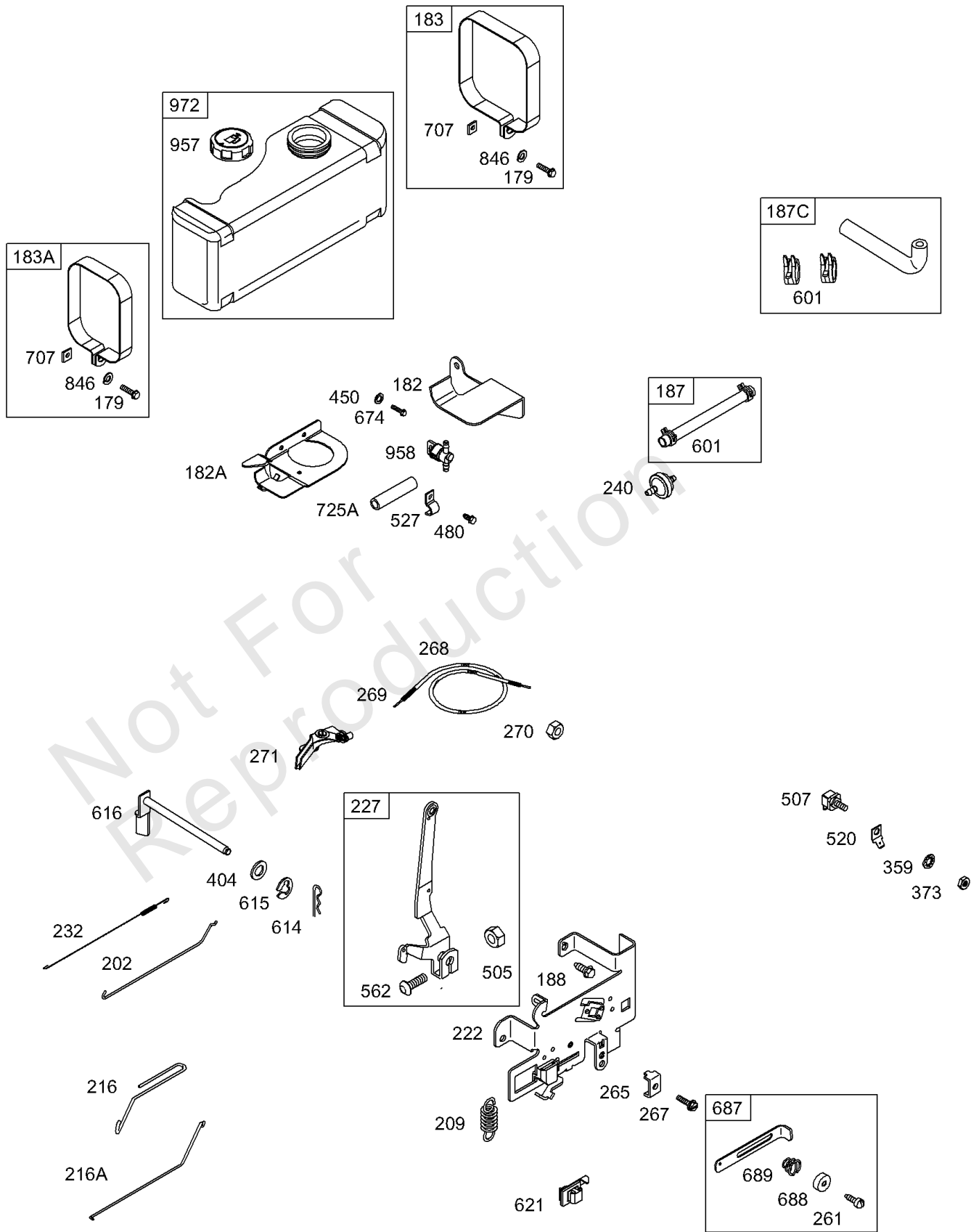

Controls, Springs, Fuel, Links

REF NO	PART NO	QTY	DESCRIPTION
179	692331		SCREW -(Fuel Tank Strap)
182	690443		BRACKET-FUEL TANK -(Right Hand)
182A	692535		BRACKET-FUEL TANK -(Left Hand)
183	698459		STRAP-FUEL TANK -(Right Hand)
183A	692030		STRAP-FUEL TANK -(Left Hand)
187	296004		LINE, Fuel -(Cut To Required Length)
187C	699331		LINE, Fuel -(Formed)(10-1/4)(Cut to Required Length)
188	691693		SCREW -(Control Bracket)
202	691841		LINK, Mechanical Governor
209	690480		SPRING, Governor -(Red)
216	691840		LINK, Choke
222	694042		BRACKET, Control
227	691374		LEVER, Governor Control
232	691842		SPRING, Governor Link
240	298090S		FILTER, Fuel -(Red)
240	394358S		FILTER, Fuel -(White)
261	690278		SCREW -(Control Slide)
265	691024		CLAMP, Casing
267	690804		SCREW -(Casing Clamp)
268	691025		CASING, Control Wire -(Cut To Required Length)
269	691026		WIRE, Control -(Cut To Required Length)
270	691027		NUT -(Control Wire Casing)
271	691028		LEVER, Control
359	691077		WASHER -(Ground Terminal)
373	691612		NUT -(Ground Terminal)
404	691691		WASHER -(Governor Crank)
450	690259		WASHER -(Fuel Tank Bracket) (Electric Start)
450	691261		WASHER -(Fuel Tank Bracket) (Rewind Starter)
480	690664		SCREW -(Tube Clamp)
505	691251		NUT -(Governor Control Lever)
507	691972		INSULATOR
520	691084		TERMINAL, Ground
527	690394		CLAMP, Hose
562	691119		BOLT -(Governor Control Lever)

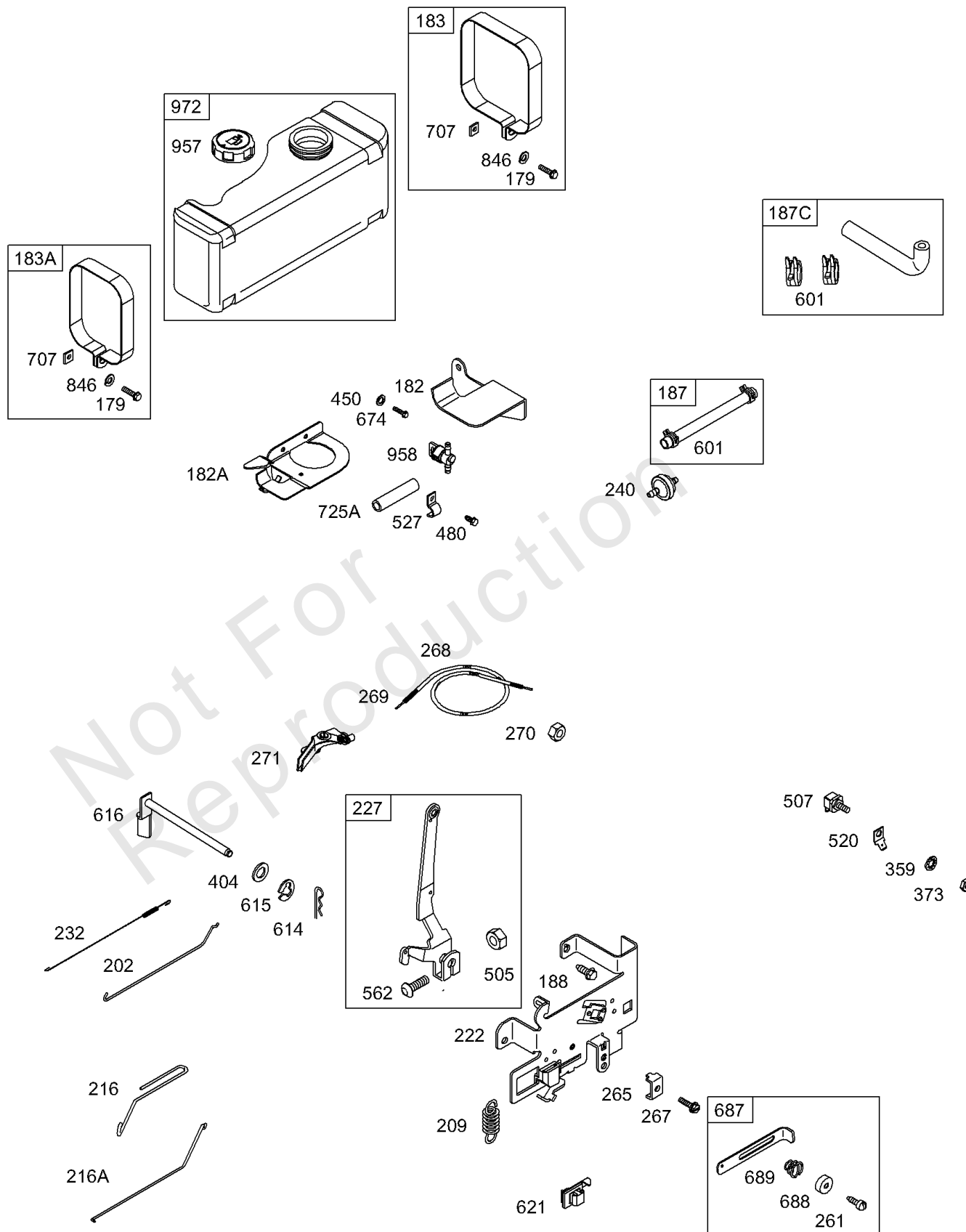

Controls, Springs, Fuel, Links

REF NO	PART NO	QTY	DESCRIPTION
601	95162S		CLAMP, Hose
614	691620		PIN, Cotter
615	93307		RETAINER, Governor Shaft
616	692012		CRANK, Governor
621	692310		SWITCH, Stop
674	690341		SCREW -(Fuel Tank Bracket) (Used On Engines With Electric Start Only)
674	691058		SCREW -(Fuel Tank Bracket) (Rewind Starter)
687	691949		SLIDE, Control
688	690395		CAP, Friction
689	690529		SPRING, Friction -(Control Bracket)
707	690279		NUT -(Fuel Tank Strap)
725A	690420		SHIELD, Heat
846	690371		WASHER -(Fuel Tank Strap)
957	493988S		CAP, Fuel Tank -(Plastic)
958	698183		VALVE, Fuel Shut Off -(Plastic)
972	390225		TANK, Fuel -(Plastic) (3 Quart Tank)

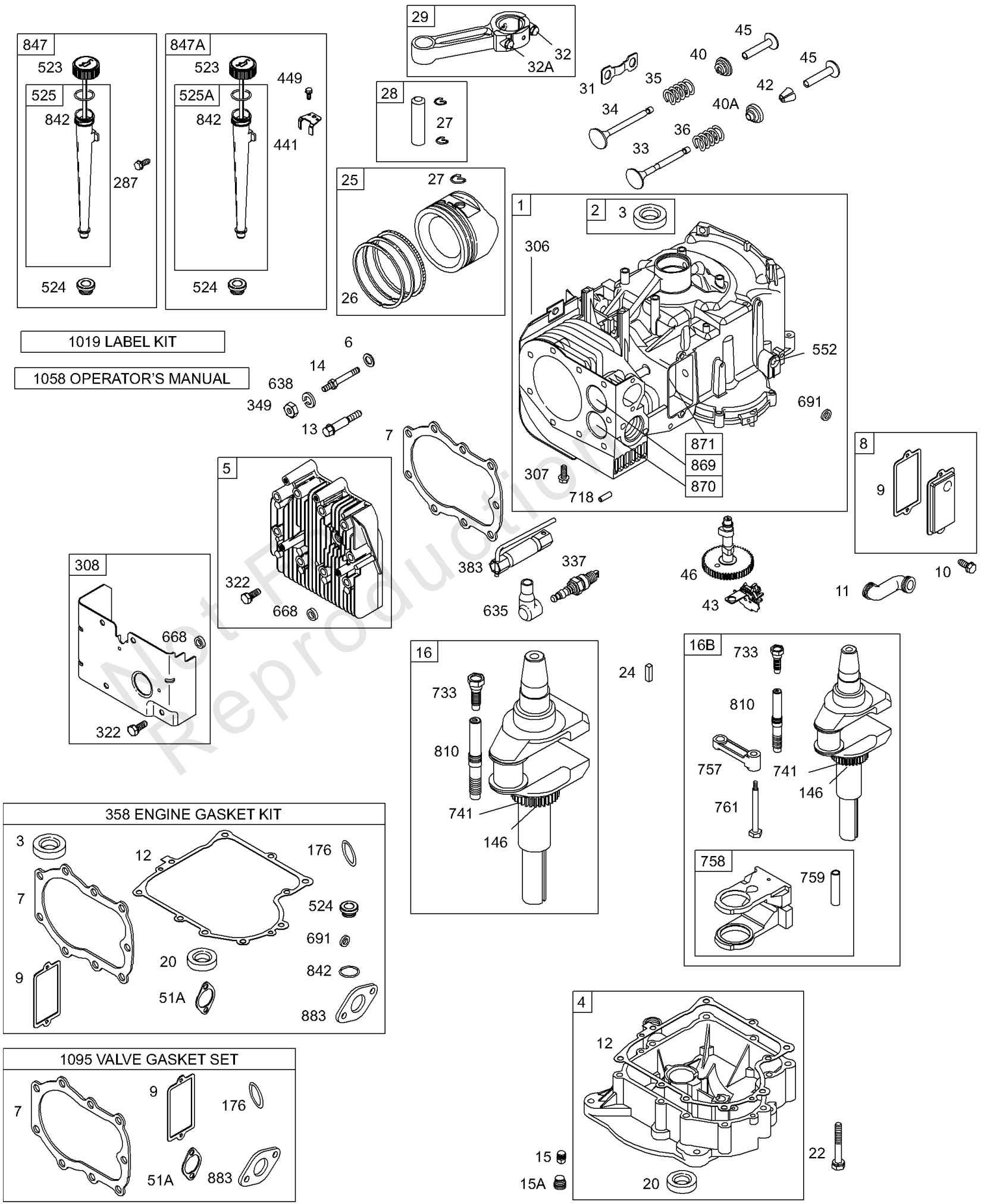

Cylinder, Oil, Crankshaft, Sump, Cam, Piston, Gaskets

REF NO	PART NO	QTY	DESCRIPTION
1	496413		CYLINDER ASSEMBLY
2	399265		KIT, Bushing/Seal -(Magneto Side)
3	391086S		SEAL, Oil -(Magneto Side)
4	494238		SUMP, Engine
5	494240		HEAD, Cylinder
6	691261		WASHER -(Cylinder Head)
7	271866S		GASKET, Cylinder Head
8	495735		BREATHER ASSEMBLY
9	27803S		GASKET, Breather
10	691666		SCREW -(Breather Assembly)
11	692253		TUBE, Breather
12	692406		GASKET, Crankcase -(.005)
12	692226		GASKET, Crankcase -(.015)(Standard)
12	692405		GASKET, Crankcase -(.009)
13	690904		SCREW -(Cylinder Head)
14	691109		STUD -(Cylinder Head)
15	690946		PLUG, Oil Drain
16	693944		CRANKSHAFT -Used After Code Date 95073100
16B	693653		CRANKSHAFT -Used Before Code Date 95080100
20	291675S		SEAL, Oil -(PTO Side)
22	692125		SCREW -(Crankcase Cover/Sump)
24	222698S		KEY, Flywheel
25	696397		PISTON ASSEMBLY -(Standard) -Used After Code Date 01060600
25	696399		PISTON ASSEMBLY -(.020 Oversize) -Used After Code Date 01060600
25	696400		PISTON ASSEMBLY -(.030 Oversize) -Used After Code Date 01060600
25	499284		PISTON ASSEMBLY -(Standard) -Used Before Code Date 01060700
25	499292		PISTON ASSEMBLY -(.020 Oversize) -Used Before Code Date 01060700
26	499998		SET, Ring -(.020 Oversize) -Used Before Code Date 01060700
26	696403		SET, Ring -(Standard) -Used After Code Date 01060600
26	696404		SET, Ring -(.010 Oversize) -Used After Code Date 01060600
26	696405		SET, Ring -(.020 Oversize) -Used After Code Date 01060600

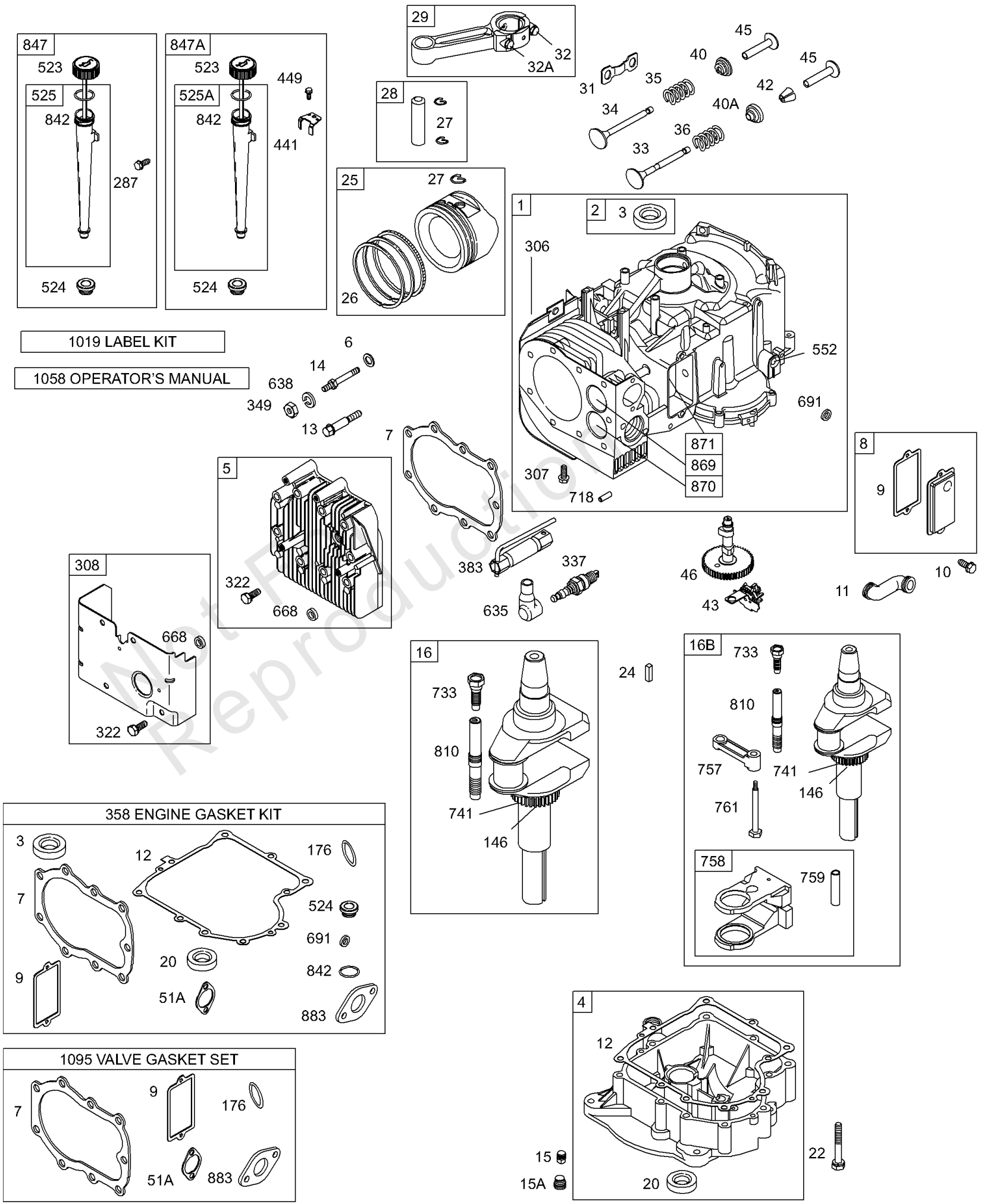

Cylinder, Oil, Crankshaft, Sump, Cam, Piston, Gaskets

REF NO	PART NO	QTY	DESCRIPTION
26	696406		SET, Ring -(.030 Oversize) -Used After Code Date 01060600
26	392331		SET, Ring -(Standard)(Chrome) -Used Before Code Date 01060700
26	499996		SET, Ring -(Standard) -Used Before Code Date 02060700
27	691299		LOCK, Piston Pin -Used After Code Date 95101500
27	691792		LOCK, Piston Pin -Used Before Code Date 95101600
28	498319		PIN, Piston -(Standard) -Used After Code Date 95101500
28	498320		PIN, Piston -(.005 Oversize) -Used After Code Date 95101500
28	299691		PIN, Piston -(Standard) -Used Before Code Date 95101600
28	391286		PIN, Piston -(.005 Oversize) -Used Before Code Date 95101600
29	495490		ROD, Connecting -(.020 Undersize)
29	494504S		ROD, Connecting -(Standard)
31	222299		LOCK, Rod Screw
32	690348		SCREW -(Connecting Rod) (1 5/8)
32A	690356		SCREW -(Connecting Rod) (1 7/8)
33	262246S		VALVE, Exhaust
34	262247S		VALVE, Intake
35	691605		SPRING, Valve -(Intake)
36	691597		SPRING, Valve -(Exhaust)
40	690656		RETAINER, Valve -(Intake)
40A	691939		RETAINER-VALVE -(Exhaust)
42	494553		KEEPER, Valve -(Exhaust)
43	691968		SLINGER, Governor/Oil
45	691811		TAPPET, Valve
46	697668		CAMSHAFT
51A	272554S		GASKET, Intake
146	691639		KEY, Woodruff
176	691917		SEAL, O-Ring -(Air Cleaner Base)
287	691002		SCREW -(Dipstick Tube)
306	698477		SHIELD-CYLINDER
307	691003		SCREW -(Cylinder Shield)
308	491490		COVER, Cylinder Head

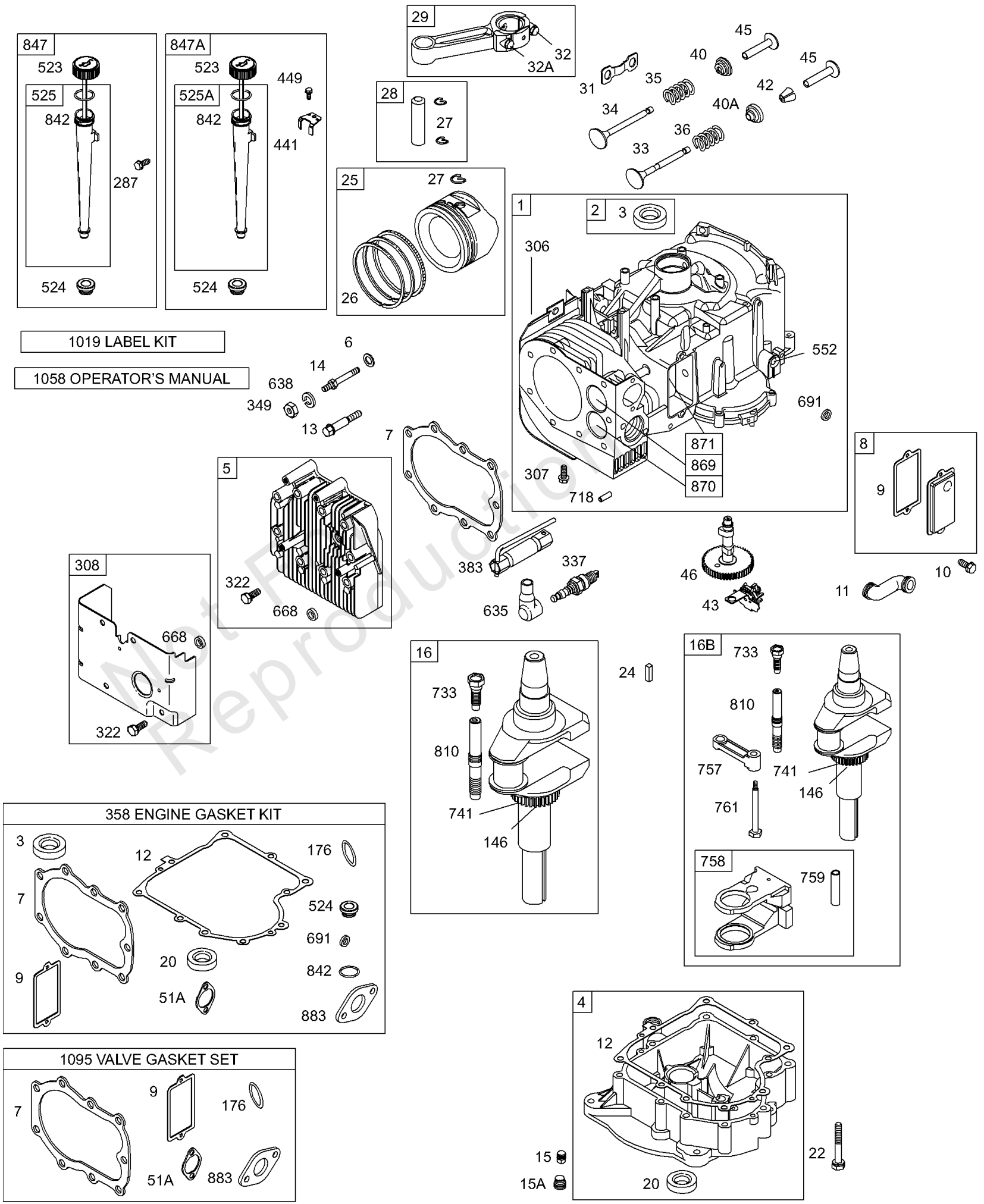

Cylinder, Oil, Crankshaft, Sump, Cam, Piston, Gaskets

REF NO	PART NO	QTY	DESCRIPTION
322	692198		SCREW -(Cylinder Head Cover)
337	802592S		PLUG, Spark -(Resistor)
349	691105		LOCKNUT -(Cylinder Head Cover)
358	494241		GASKET SET, Engine
383	89838S		WRENCH-SPARK PLUG
441	224390		BRACKET, Oil Fill
449	691678		SCREW -(Oil Fill Bracket)
523	692014		DIPSTICK
524	281370S		SEAL-DIPSTICK TUBE -(Dipstick Tube)
525	691398		TUBE, Dipstick
525A	495768		TUBE, Dipstick
552	491986		BUSHING, Governor Crank -(1/4 I.D.)
635	66538S		BOOT, Spark PLug
638	691075		WASHER -(Cylinder Head Cover)
668	690510		SPACER -(Cylinder Head Cover)
691	692407		SEAL, Governor Shaft
718	690959		PIN, Locating
733	691658		SCREW -(Crankshaft Extension)
741	691284		GEAR, Timing
757	691714		LINK, Counterweight -(-Used After Code Date 78100411)
758	692423		COUNTERWEIGHT
759	691239		PIN, Counterweight
761	691096		SCREW -(Counterweight)
810	691779		EXTENSION, Crankshaft
842	691870		SEAL, O-Ring -(Dipstick Tube)
847	496415		DIPSTICK/TUBE ASSEMBLY
847A	490474		DIPSTICK/TUBE ASSEMBLY
869	691802		SEAT, Valve -(Intake)
870	691844		SEAT-VALVE -(Exhaust)
871	231218		BUSHING, Valve Guide -(Brass)
871	261961		BUSHING, Valve Guide -(Exhaust)
883	692236		GASKET, Exhaust
1019	491255		KIT, Label
1058	274787		MANUAL, Operator's
1095	498539		GASKET SET, Valve

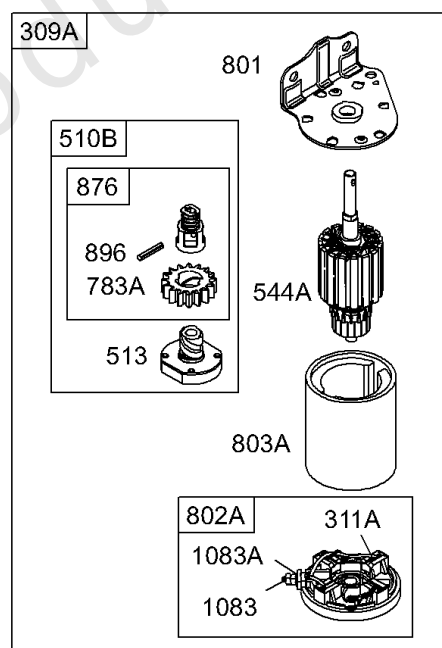
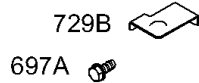
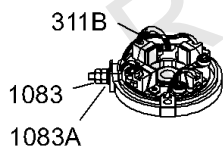
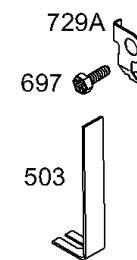
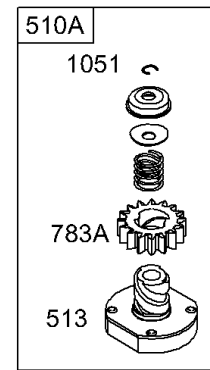
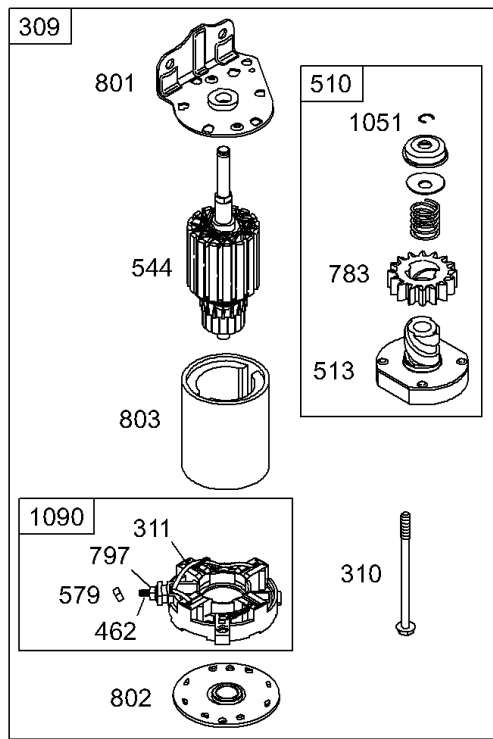

NOTE: For Replacement Starter Motor, See Reference 309.

Electric Starters

REF NO	PART NO	QTY	DESCRIPTION
309	499521		MOTOR, Starter -(4 3/8 Housing Length For Aluminum Ring Gear Only)
309	693054		MOTOR, Starter -(3 5/8) (Aluminum Ring Gear)
309	693551		MOTOR, Starter -(3 5/8 Housing Length For Steel Ring Gear Only)
309	693552		MOTOR, Starter -(4 3/8 Housing Length For Steel Ring Gear Only)
309	497401		MOTOR, Starter -(4 3/8 Housing Length For Plastic Ring Gear Only)
309	497595		MOTOR, Starter -(3 5/8) (Plastic Ring Gear)
309A	-----		Motor-Starter -(For Replacement Starter Motor, Order Reference 309)
310	690323		SCREW -(Starter Motor) (For 3 5/8" Housing Length)
310	691263		BOLT -(Starter Motor) (4 3/8 Housing)
310	692329		BOLT -(Starter Motor) (4 9/16 Housing)
311	497608		SET, Brush
311A	395538		SET, Brush -(3 5/8 Housing)
311B	490311		SET, Brush -(4 9/16 Housing)
462	691261		WASHER -(Starter Cable)
503	691532		STRAP, Starter
510	693699		DRIVE, Starter -(Used With Steel Ring Gear)
510A	696541		DRIVE, Starter -(Used With Aluminum And Plastic Ring Gears)
510B	696540		DRIVE, Starter -(4 3/8 Housing)
513	692024		CLUTCH, Drive
544	692034		ARMATURE, Starter -(3 5/8 Housing)
544A	490309		ARMATURE, Starter -(4 3/8 Housing)
544A	390837		ARMATURE, Starter -(3 5/8 Housing)
579	691029		NUT -(Starter Cable)
697	690372		SCREW -(Drive Cap)
697A	691058		SCREW -(Drive Cap)
729A	691224		CLIP, Wire
729B	224723		CLIP, Wire
783	693713		GEAR, Pinion
783A	695708		GEAR-PINION
797	693167		NUT -(Brush Retainer)
801	691283		CAP, Drive
802	691286		CAP, End
802A	395537		CAP, End -(3 5/8 Housing)
803	693757		HOUSING, Starter -(3 5/8 Housing)

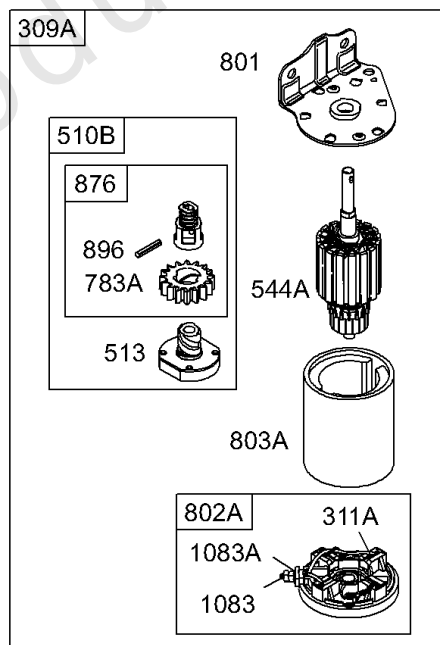
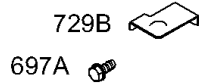
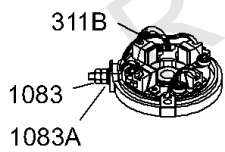
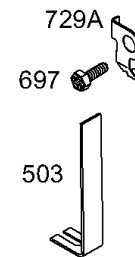
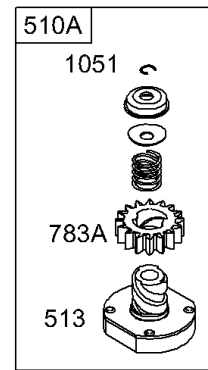
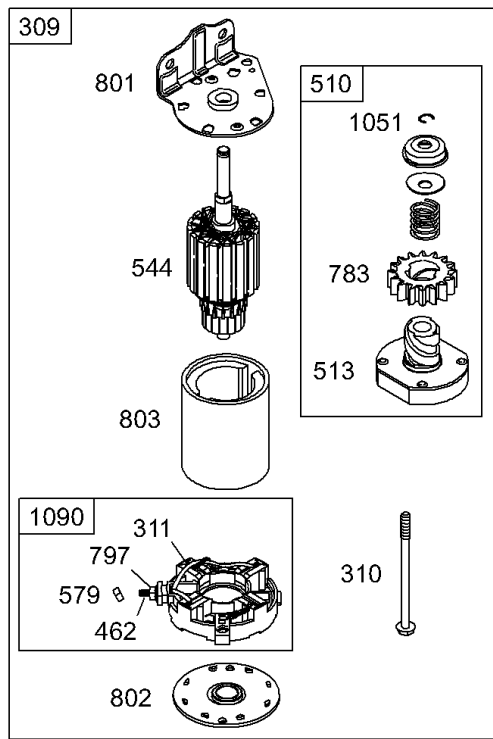

NOTE: For Replacement Starter Motor, See Reference 309.

Electric Starters

REF NO	PART NO	QTY	DESCRIPTION
803A	398159		HOUSING, Starter -(3 5/8 Housing)
803A	494205		HOUSING, Starter -(4 3/8 Housing)
876	696539		KIT, Pinion Spring
896	691641		PIN, Drive Retainer
1051	691265		RING, Retaining
1083	691626		NUT -(End Cap)
1083A	690958		NUT -(End Cap)
1090	691293		RETAINER, Brush

Not For Reproduction

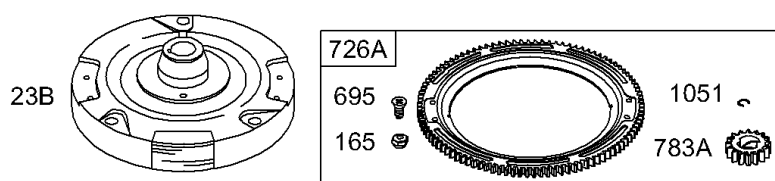
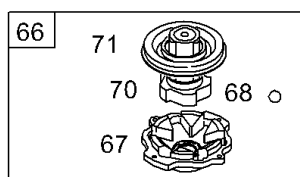
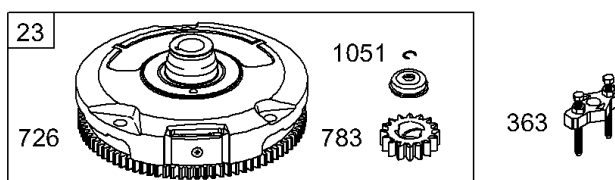
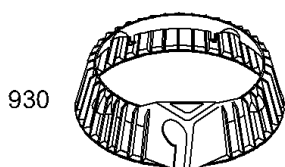
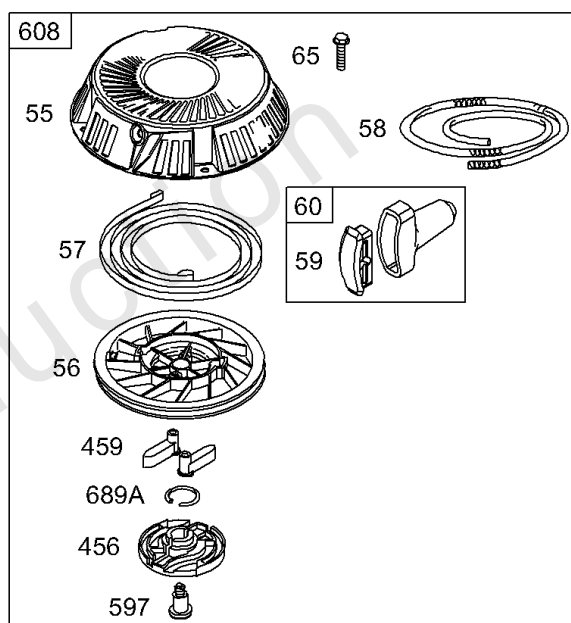
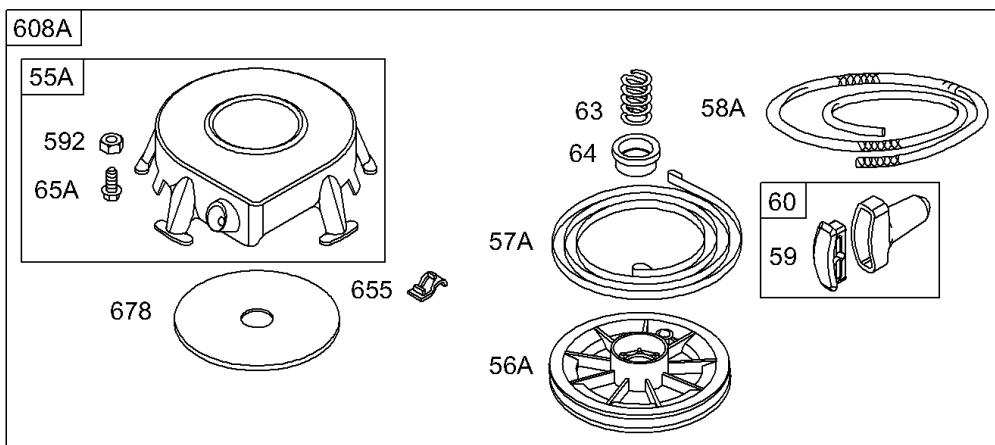

Flywheel, Rewind Starter

REF NO	PART NO	QTY	DESCRIPTION
23	693557		FLYWHEEL -(Steel Ring Gear)
23B	693555		FLYWHEEL
55	695130		HOUSING, Rewind Starter -Used After Code Date 99102400
55A	393576		HOUSING, Rewind Starter -Used Before Code Date 99102500
56	695129		PULLEY, Starter -Used After Code Date 99102400
56A	295871		PULLEY, Starter -Used Before Code Date 99102500
57	695131		SPRING, Rewind Starter -Used After Code Date 99102400
57A	490179		SPRING-REWIND STR -Used Before Code Date 99102500
58	695132		ROPE, Starter -Used After Code Date 99102400
58A	692188		ROPE, Starter -Used Before Code Date 99102500
59	490653		INSERT, Grip
60	490652		GRIP-STARTER ROPE
63	690547		SPRING, Ratchet -Used Before Code Date 99102500
64	691920		ADAPTER, Ratchet Spring -Used Before Code Date 99102500
65	695453		SCREW -(Rewind Starter) -Used After Code Date 99102400
65A	690837		SCREW -(Rewind Starter) -Used Before Code Date 99102500
66	399671		CLUTCH-STARTER -Used Before Code Date 99102500
67	394897		HOUSING, Clutch -Used Before Code Date 99102500
68	691604		BALL, Clutch -Used Before Code Date 99102500
70	691945		RATCHET-CLUTCH -Used Before Code Date 99102500
71	691359		COVER, Ratchet -Used Before Code Date 99102500
165	693148		NUT -(Ring Gear)
363	19203		PULLER, Flywheel
456	695128		PLATE, Pawl Friction -Used After Code Date 99102400
459	281505S		PAWL-RATCHET -Used After Code Date 99102400
592	690800		NUT -(Rewind Starter) -Used Before Code Date 99102500
597	691696		SCREW -(Pawl Friction Plate) -Used After Code Date 99102400
608	695058		STARTER, Rewind -Used After Code Date 99102400
608A	390391		STARTER, Rewind -Used Before Code Date 99102500
655	691734		ANCHOR-REWIND SPRING -Used Before Code Date 99102500

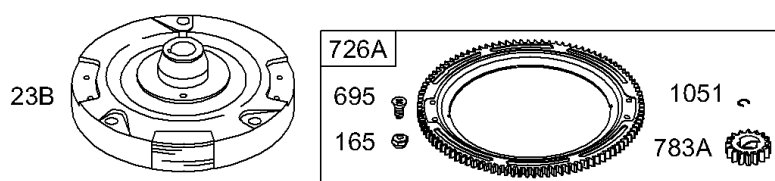
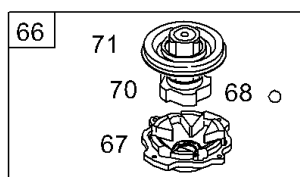
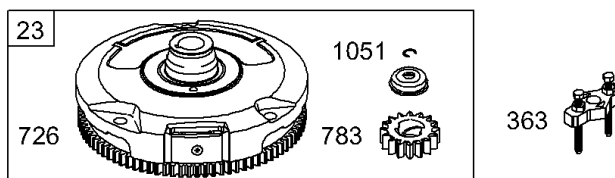
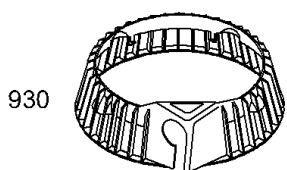
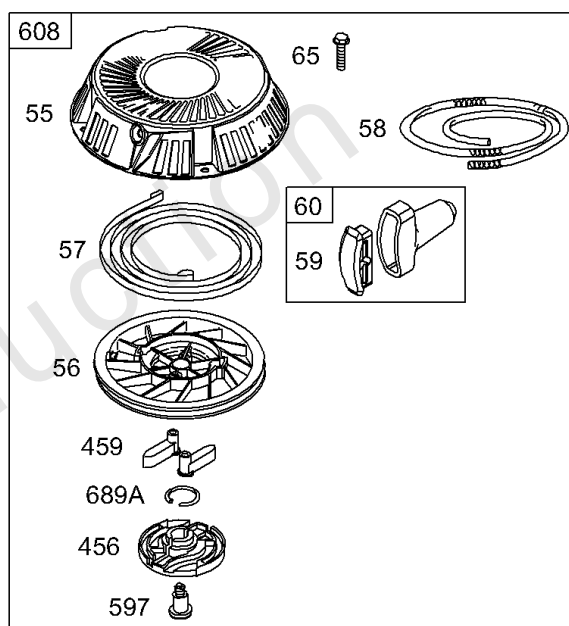
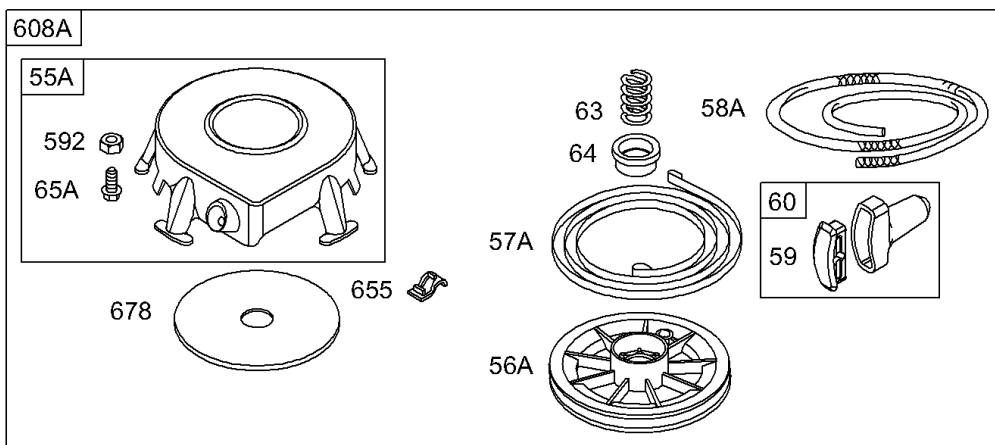

Flywheel, Rewind Starter

REF NO	PART NO	QTY	DESCRIPTION
678	490817		SPACER-REWIND -(Rewind) -Used Before Code Date 99102500
689A	691855		SPRING-FRICTION -(Rewind Starter)
695	693109		SCREW -(Ring Gear)
726	-----		Gear-Ring -(Steel)(See Reference 23 for Service)
726A	696537		GEAR, Ring -(Aluminum)(Services Plastic Ring Gear Only)
783	693713		GEAR, Pinion
783A	695708		GEAR-PINION
930	691904		GUARD, Rewind -Used Before Code Date 99102500
1051	691265		RING, Retaining

Not For Reproduction

Replacement Engine - US & Canada

REF NO	PART NO	QTY	DESCRIPTION
	2199073026	1	Replacement Engine
	-----		Top No-Load Speed: 3300 -Trim: ALL
	-----		Service Note: If the replacement engine supersedes to or is a Model 210000 series engine, refer to the illustrations located after the conversion data for this model series. The overall dimensions which differ, are shown in the illustrations.
	-----		Service Note: If after making a visual inspection and it is determined the Model 210000 series engine cannot be used because of equipment interference, the original engine should be repaired with a short block and/or individual parts.
	-----		Service Note: If the original engine is equipped with a Six Pin Wiring Harness transfer to the replacement engine.

Not For Reproduction

