

零件手册

制造编号: 126T02-0675-B1



模型组件	页
凸轮轴, 曲轴, 缸体, 发动机油底壳, 润滑, 活塞组, 阀门.....	4
化油器.....	12
导风罩, 飞轮, 启动拉盘.....	16
护罩.....	20
控制, 电气, 飞轮刹车, 调速弹簧.....	22
替代发动机-美国和加拿大.....	26
燃料供应, 点火.....	27
电启动器, 垫片套件.....	29
空气滤清器, 排气系统.....	33

Not For
Reproduction

1319 WARNING LABEL

1330 REPAIR MANUAL

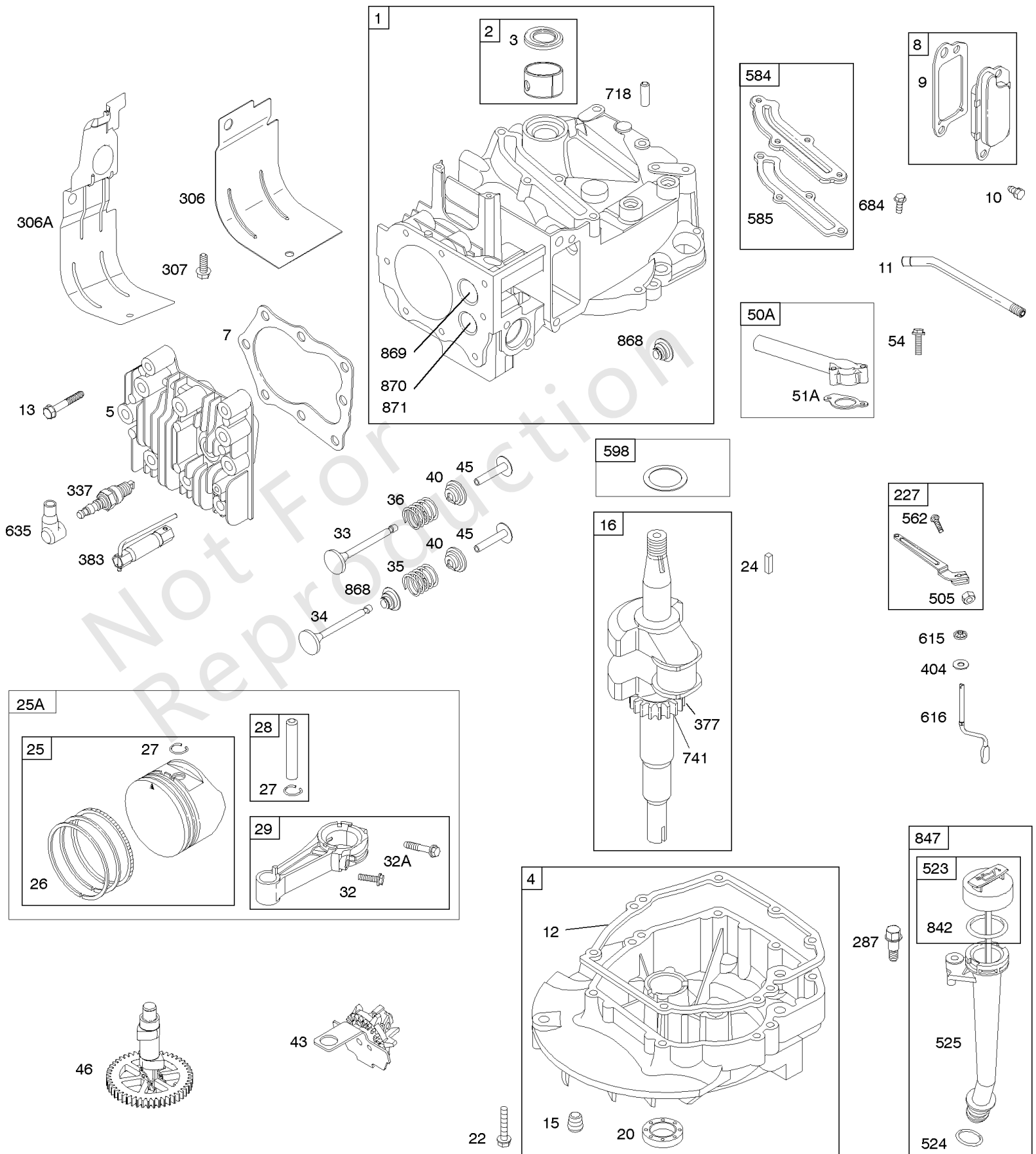

凸轮轴, 曲轴, 缸体, 发动机油底壳, 润滑, 活塞组, 阀门

参考编号	零件号	数量	描述
1	592645		缸体组件
2	796961		套件, 衬套/密封件 - (磁铁侧)
3	299819S		海豹油 - (磁铁侧)
4	493279		油底壳, 发动机
5	594989		Head-Cylinder
7	692249		垫片, 缸头 -在代码日期11070100 -之前使用
7	799875		垫片, 缸头 -在代码日期11063000 -之后使用
8	590395		呼吸器 组件
9	699833		GASKET-BREATHER
10	691125		拧 - (呼吸器组装)
11	691781		TUBE-BREATHER
12	692232		垫片, 曲轴箱盖
13	690912		拧 - (缸头) 代码日期11070100 -之前使用
13	590422		拧 - (缸头) 代码日期11063000后使用
15	690946		插头, 排油 - (3/8 "-18 NPTF-外部7/16" Sq)
15	691680		插头, 排油 - (3/8 "-18 NPTF - 内部3/8" Sq)
16	797017		曲轴
20	399781S		海豹油 - (PTO方)
22	691092		拧 - (曲轴箱盖/油底壳)
24	222698S		钥匙, 飞轮
25	799064		活塞组件 - (.020 加大) 在代码日期09041700 -之前使用
25	590404		活塞组件 - (标准) 代码日期07090300后使用
25	590405		活塞组件 - (.020加大) 代码日期09041600后使用
25	799063		活塞组件 - (标准) 在代码日期07090400 -之前使用
25A	590406		活塞组件 - (标准) 在代码日期09041700 -之前使用
26	797304		套装, 戒指 - (更换, 参见参考号25,590404) 代码日期后使用09041600代码日期前使用 11070100
26	797305		套装, 戒指 -代码日期09041600 -之后使用的 (.020加大) 代码日期11070100 -之前使用
26	590402		套装, 戒指 - (标准) 代码日期11063000后使用
26	590403		套装, 戒指 -代码日期11063000后使用 (.020加大)
26	791098		套装, 戒指 - (标准) 在代码日期07090400 -之前使用

1319 WARNING LABEL

1330 REPAIR MANUAL

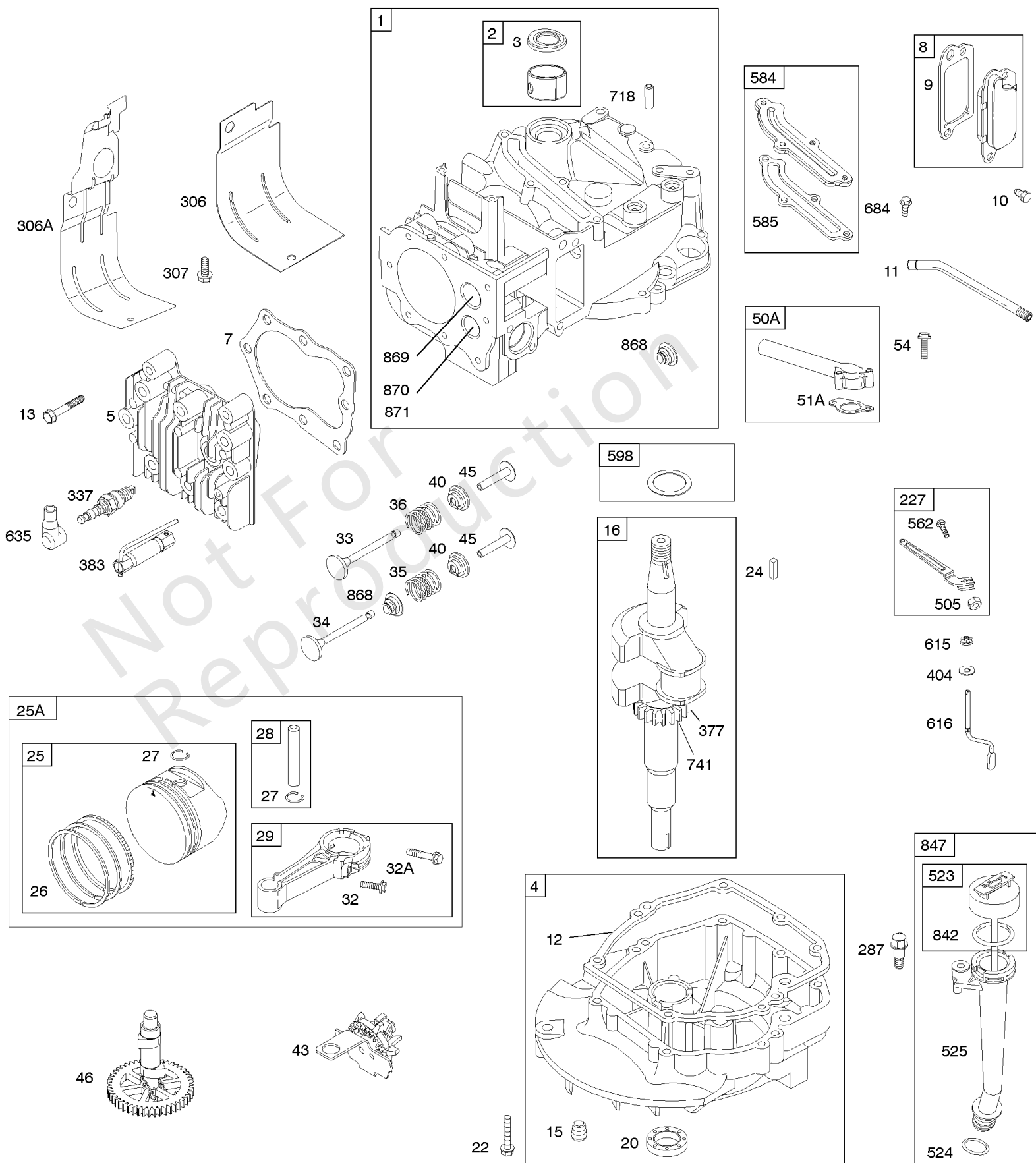

凸轮轴, 曲轴, 缸体, 发动机油底壳, 润滑, 活塞组, 阀门

参考编号	零件号	数量	描述
26	791324		套装, 戒指 - (.020 加大) 在代码日期07090400 -之前使用
26	795431		戒指套装 - (标准) 代码日期07090300 -之后使用代码日期09041700 -之前使用
26	795432		套装, 戒指 -代码日期07090300在代码日期09041700 -之前使用后使用 (.020加大)
27	691866		Lock-Piston Pin -在代码日期09041700 -之前使用
27	691588		锁, 活塞销 -在代码日期09041600 -之后使用
28	499423		PIN-PISTON/STD - (标准) 在代码日期09041700 -之前使用
28	298909		PIN. Piston - (标准) 在代码日期09041600 -之后使用
29	797306		杆, 连接 - (标准) 在代码日期09041600 -之后使用
29	499424		杆, 连接 - (替换, 参见参考号25A, 590406) 在代码日期09041700 -之前使用
32	691664		拧 - (连杆)
32A	695759		拧 - (连杆)
33	590394		VALVE-EXHAUST -在代码日期11063000 -之后使用
34	590393		Valve-Intake -在代码日期11063000 -之后使用
35	691270		弹簧, 阀门 - (排气) (进气)
36	691270		弹簧, 阀门 - (排气)
40	692194		保持器, 阀门
43	691997		抛油环, 调速/机油
45	690548		挺杆, 阀门
46	691449		凸轮轴
50A	794305		歧管, 摄入量
51A	794306		垫片, 进气管
54	691650		拧 - (进气歧管)
227	690783		LEVER-GOV CONTROL
287	690940		拧 - (试纸管)
306	690450		护罩, 缸体
306A	790836		护罩, 缸体
307	690345		拧 - (呼吸器组装) (缸体护罩)
337	593941		塞, 火花 -在代码日期11063000 -之后使用

1319 WARNING LABEL

1330 REPAIR MANUAL

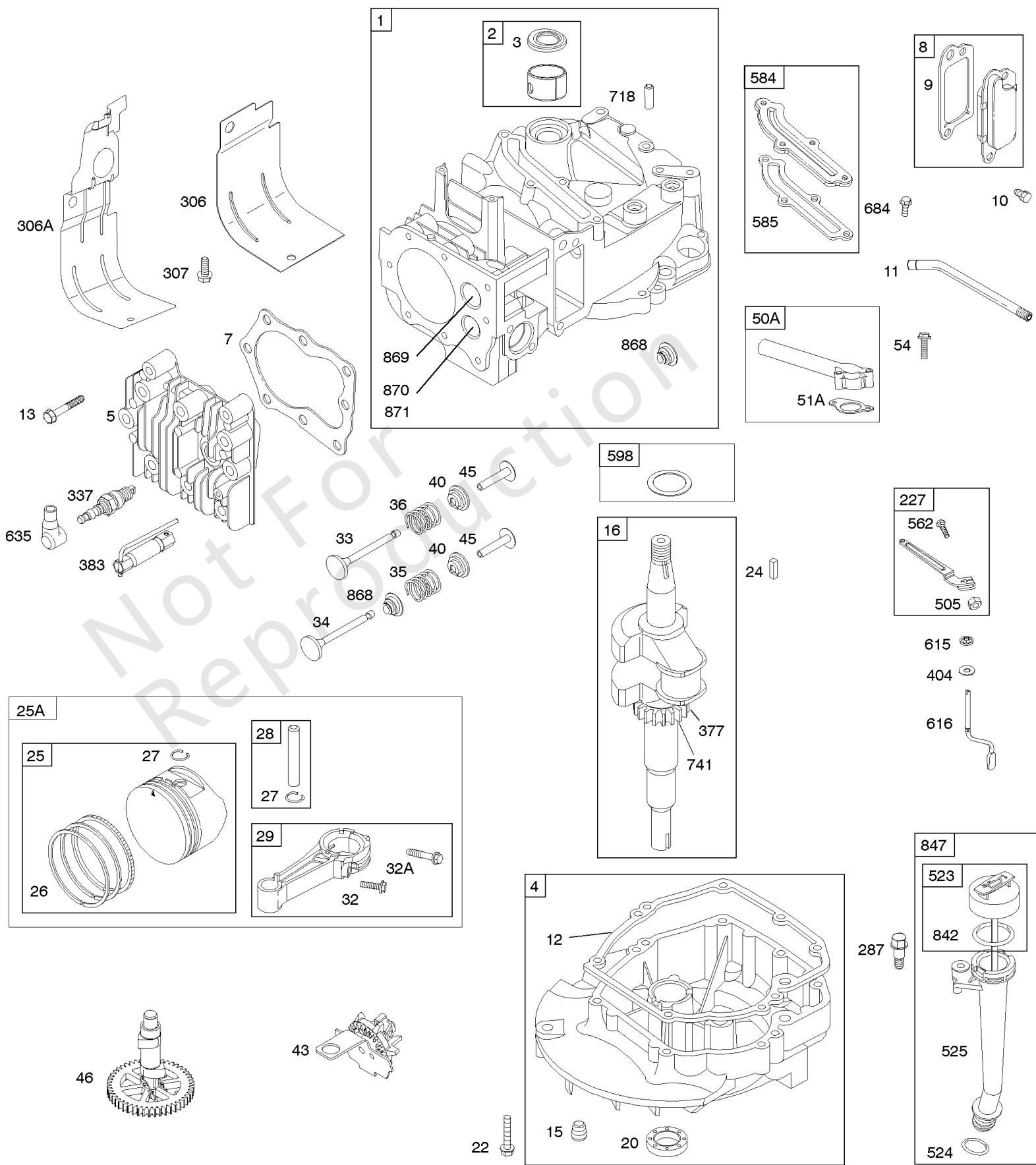

凸轮轴, 曲轴, 缸体, 发动机油底壳, 润滑, 活塞组, 阀门

参考编号	零件号	数量	描述
337	697451		塞, 火花 - (EMS) 在代码日期11070100 -之前使用
337	796112S		PLUG-SPARK - (电阻器) 在代码日期11070100 -之前使用
377	690979		键, 半月形
383	89838S		Wrench-Spark Plug
404	690272		垫圈 - (调速克兰克)
505	691251		坚果 - (调速控制杆)
523	499621		机油尺
524	692296		Seal-Dipstick Tube - (试纸管)
525	495265		管子, 机油尺
562	691119		螺栓 - (调速控制杆)
584	697734		COVER-BREA PASSAGE
585	691879		GASKET-BREA PASSAGE
598	592587		垫片, 结束游戏 - (曲轴或凸轮轴轴承) (0.012)
615	690340		固定器, 调速轴
616	698801		Crank-Governor
635	66538S		帽, 火花塞
684	690345		拧 - (呼吸器组装) (呼吸器通道盖)
718	690959		销, 定位
741	797521		齿轮, 正时 - (金属) 代码日期08021700后使用
741	691830		GEAR-TIMING - (使用半月形钥匙)
741	790345		齿轮, 正时 - (使用没有半月形钥匙) 在代码日期07100100 -之前使用
741	794388		齿轮, 正时 - (在没有半月形钥匙的情况下使用) 代码日期07093000在代码日期08021800 -之前使用
842	691031		密封圈, O形圈 - (试纸管)
847	692047		DIPSTICK/TUBE ASSY
868	697338		密封, 阀门 -在代码日期11070100 -之前使用
868	590410		密封, 阀门 -在代码日期11063000 -之后使用
869	691155		座椅, 阀门 - (录取)
870	690380		座椅, 阀门 - (排气)
871	262001		BUSHING-VALVE GUIDE - (排气) 在代码日期11070100 -之前使用
871	590409		套管, 阀门导轨 - (进气和排气) 代码日期11063000后使用
871	63709		套管, 阀门导轨 - (摄入) 代码日期11070100 -之前使用

1319 WARNING LABEL

1330 REPAIR MANUAL

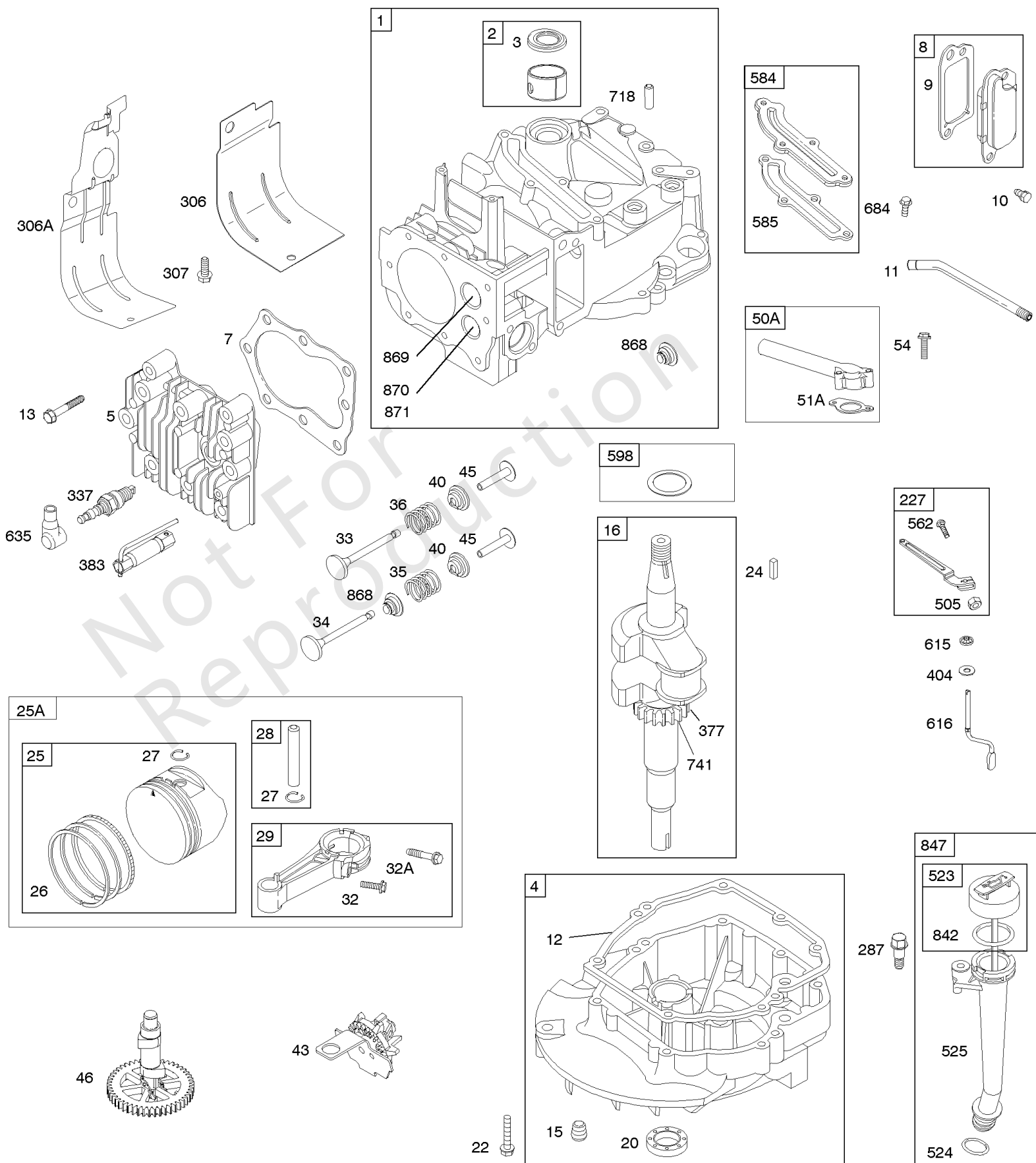

凸轮轴, 曲轴, 缸体, 发动机油底壳, 润滑, 活塞组, 阀门

参考编号	零件号	数量	描述
1319	794467		标签, 警告
1330	270962		REP MAN-1 CYL L-HD

Not For Reproduction

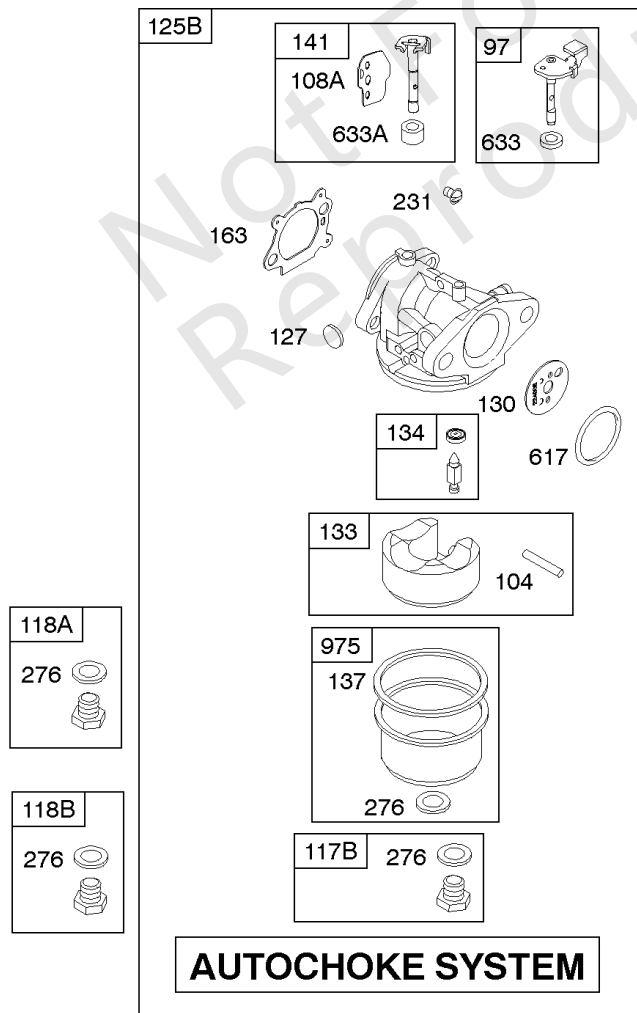
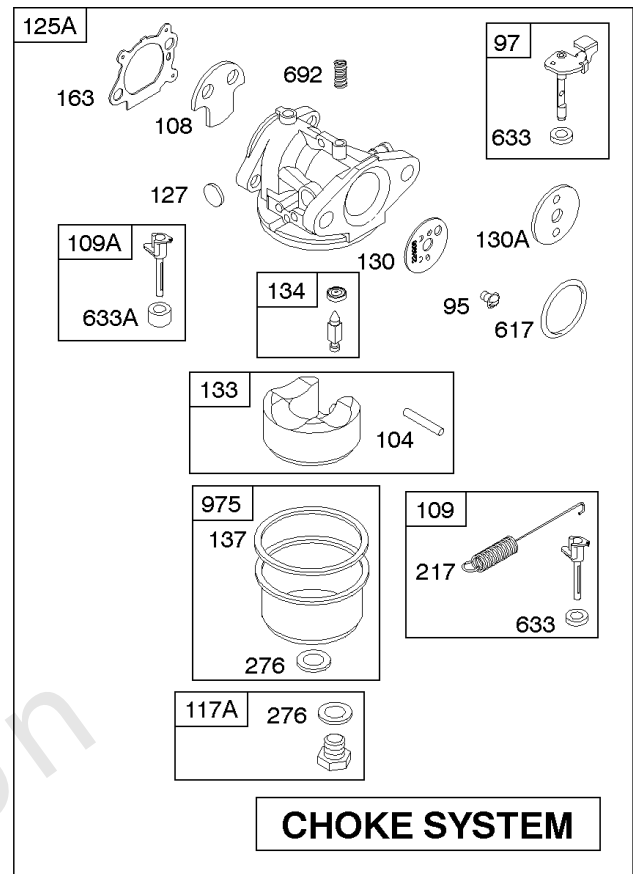
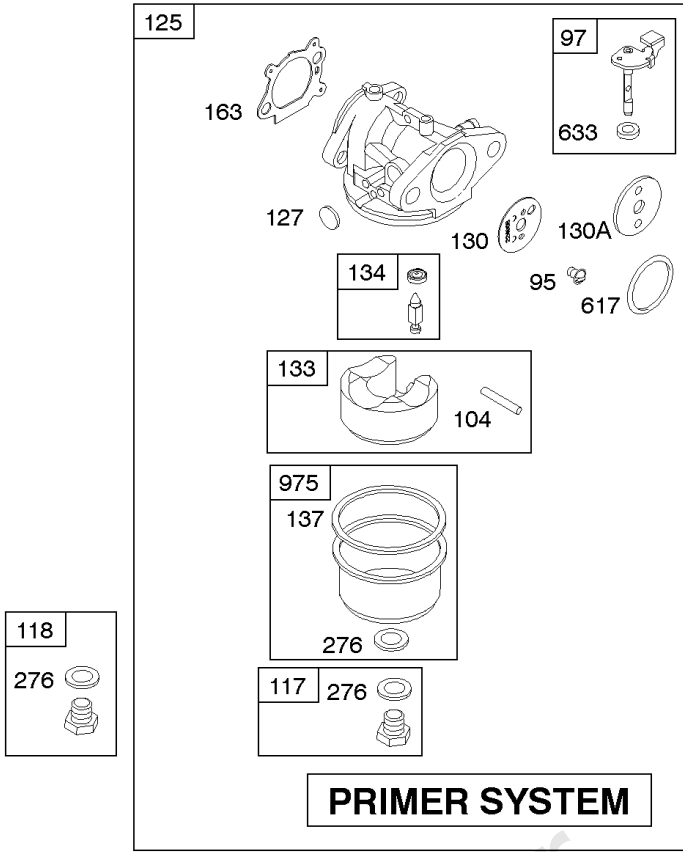

化油器

参考编号	零件号	数量	描述
95	691636		拧 - (节气门)
97	493267		轴, 油门 - (金属)
97	696565		轴, 油门 - (塑料)
104	797622		Pin-Float Hinge
108	691182		Valve-Choke
108A	795935		阀门, 阻风门 -在代码日期08031200 -之后使用
108A	790844		阀门, 阻风门 -在代码日期08031300 -之前使用
109	494218		套件, 阻风门 轴
109A	498593		轴, 阻风门
117	498978		喷嘴, 主 - (标准)
117A	498981		喷嘴, 主 - (标准)
117B	498977		喷嘴, 主 - (标准) 代码日期08061900后使用
117B	697355		喷嘴, 主 - (标准) 在代码日期07020700 -之前使用
117B	691428		喷嘴, 主 - (标准) 在代码日期07020600 -之后使用代码日期08062000 -之前使用
118	798660		喷嘴, 主 - (高海拔)
118A	494870		喷嘴, 主 - (高海拔)
118B	695042		喷嘴, 主 -代码日期07020600代码日期08062000 -之前使用的 (高海拔)
118B	692677		喷嘴, 主 - (高海拔) 在代码日期07020700 -之前使用
118B	694250		喷嘴, 主 - (高海拔) 代码日期08061900后使用
125	799868		化油器 - (底漆)
125A	799869		化油器 - (呛)
125B	799866		化油器 - (自动阻风门系统) 代码日期07020600后使用
125B	799871		化油器 - (自动阻风门系统) 在代码日期07020700 -之前使用
127	694468		塞, 韦尔奇 - (碗通风口)
130	696564		阀门, 节气门
130A	691203		阀门, 节气门
133	398187		浮子化油器
134	398188		套件-针/座
137	796610		垫片, 浮子碗 - (1/8)
137	693981		垫片 - 浮球碗 - (1/16)

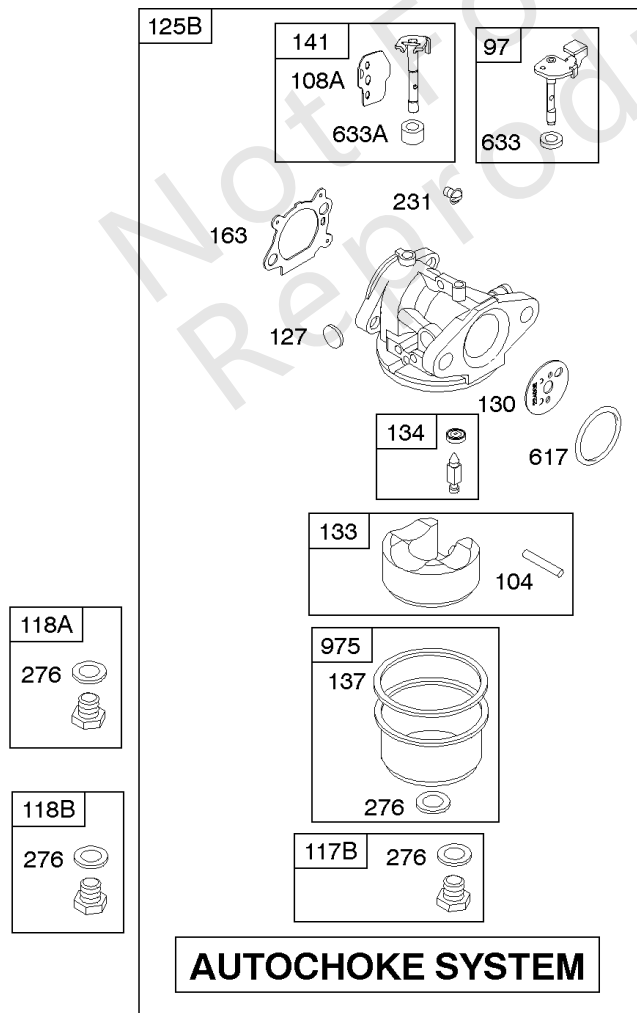
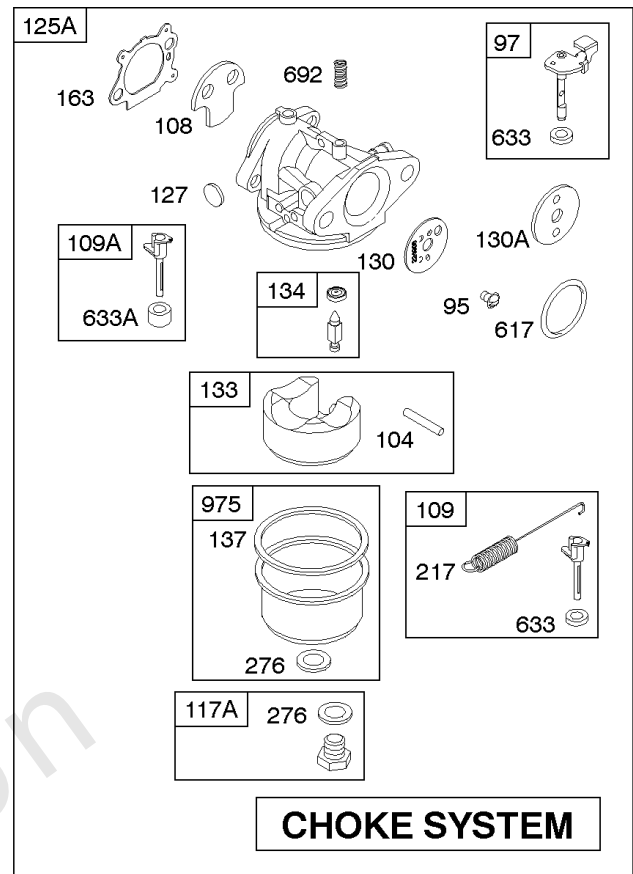
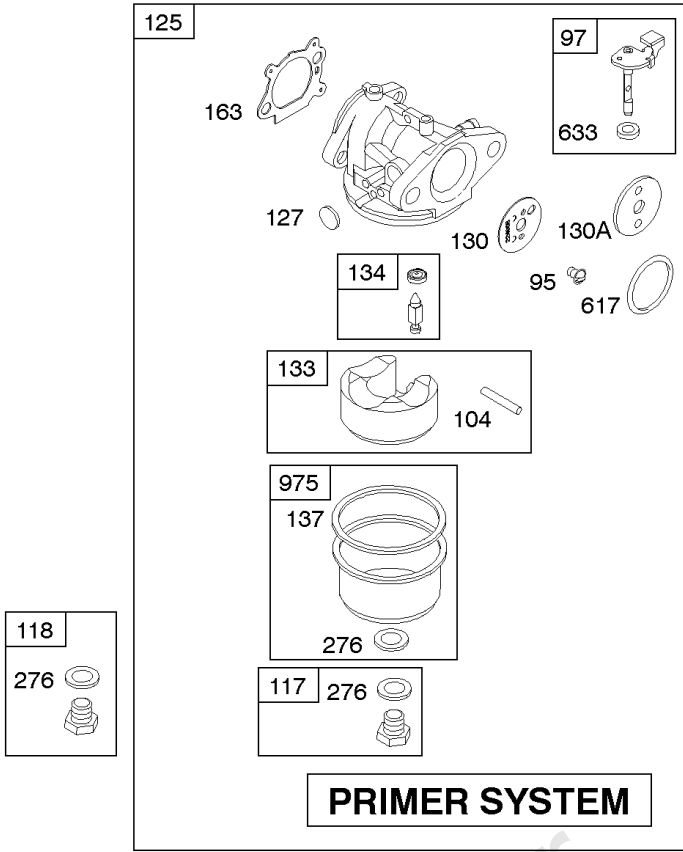

化油器

参考编号	零件号	数量	描述
141	796193		套件, 阻风门 轴 -在代码日期08031200 -之后使用
163	795629		垫片 - 空气滤清器 - (空气滤清器)
217	690354		弹簧, 阻风门 回位
231	691636		拧 - (节气门)
276	271716		垫片用密封
617	270344S		密封圈, O形圈 - (进气歧管)
633	691321		Seal-Choke/Thr Shaft - (节气门轴)
633A	693867		密封, 阻风门/节气门轴
692	590931		弹簧, 骑兵
975	796611		碗, 浮子

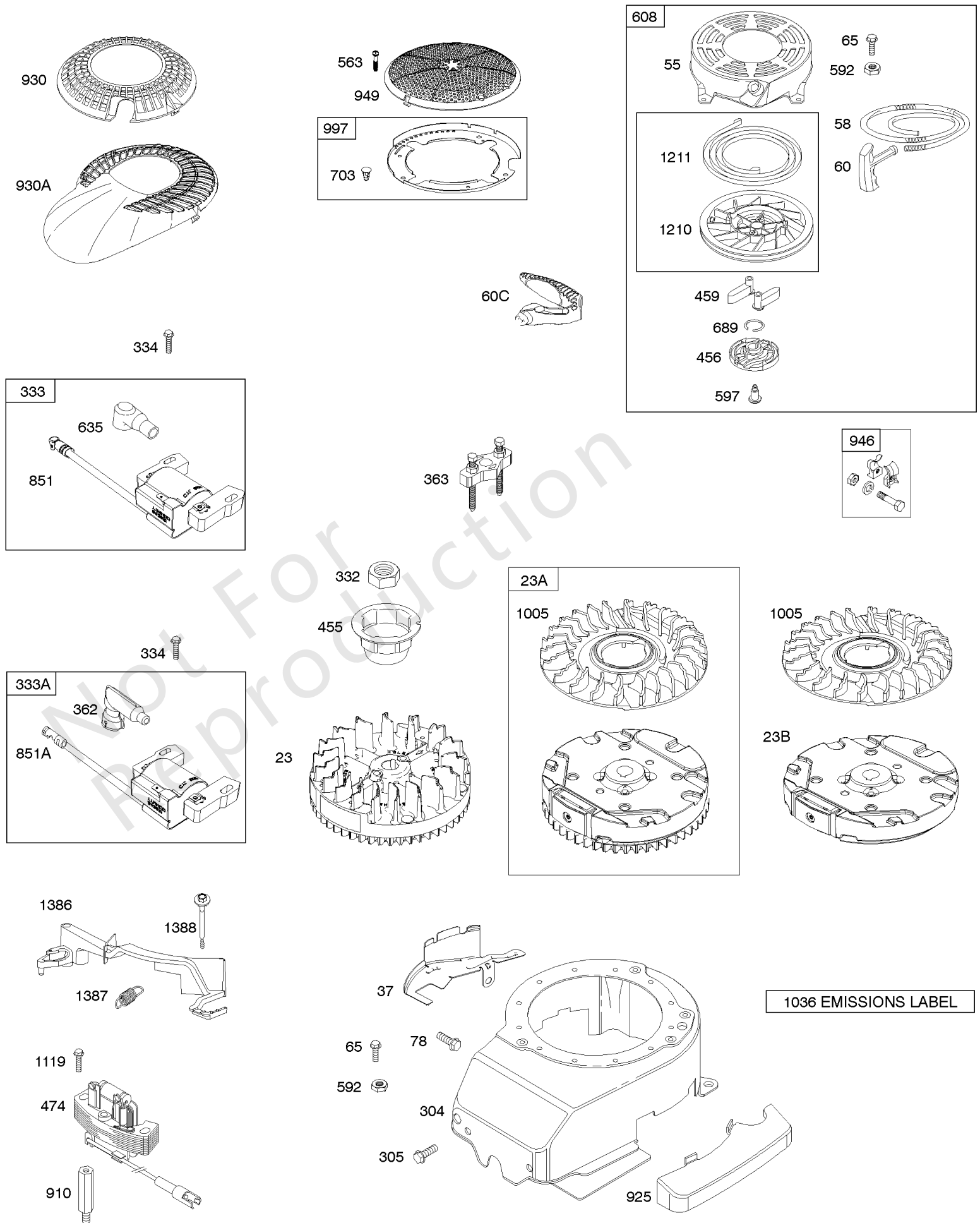

导风罩, 飞轮, 启动拉盘

参考编号	零件号	数量	描述
23	691987		飞轮
37	793756		Guard-Flywheel
55	691421		壳, 自绕回弹入门
58	697316		绳, 启动 - (切成所需长度)
60	281434S		紧握, 启动 绳
60C	799716		紧握, 启动 绳
65	690837		拧 - (启动拉盘)
78	691108		拧 - (飞轮护罩)
304	790826		壳, 导风罩
305	691108		拧 - (导风罩房)
332	690662		坚果 - (飞轮)
333	590454		ARMATURE-MAGNETO -订购Ref # 1386 空气叶片 # 790848
334	691061		拧 - (磁电枢)
362	793351		SHIELD-SPARK PLUG
363	19069		拉拔器, 飞轮
455	791960		杯, 飞轮
456	692299		板爪摩擦
459	281505S		Pawl-Ratchet
474	691991		发马达
563	691138		拧 - (碎片屏保护)
592	690800		坚果 - (启动拉盘)
597	691696		拧 - (棘爪摩擦片)
608	497680		启动, 自绕回弹
635	66538S		帽, 火花塞
689	691855		Spring-Friction
703	696309		夹
851	493880S		TERMINAL-SPARK PLUG
851A	692424		端子, 火花塞
910	691094		螺柱 - (发电线圈)
925	795403		Cover-Linkage
930	691919		保护, 自绕回弹
930A	691345		保护, 自绕回弹
946	691738		停止, 绳索
949	696306		保护, 碎片屏
997	696310		护罩, 碎片
1005	691346		风扇, 飞轮
1036	-----		Label-Emissions - (可从百力通授权经销商处获得)
1119	692979		拧 - (发电线圈)
1210	498144		PULLEY/SPRING ASSY - (滑轮)
1211	498144		PULLEY/SPRING ASSY - (弹簧)

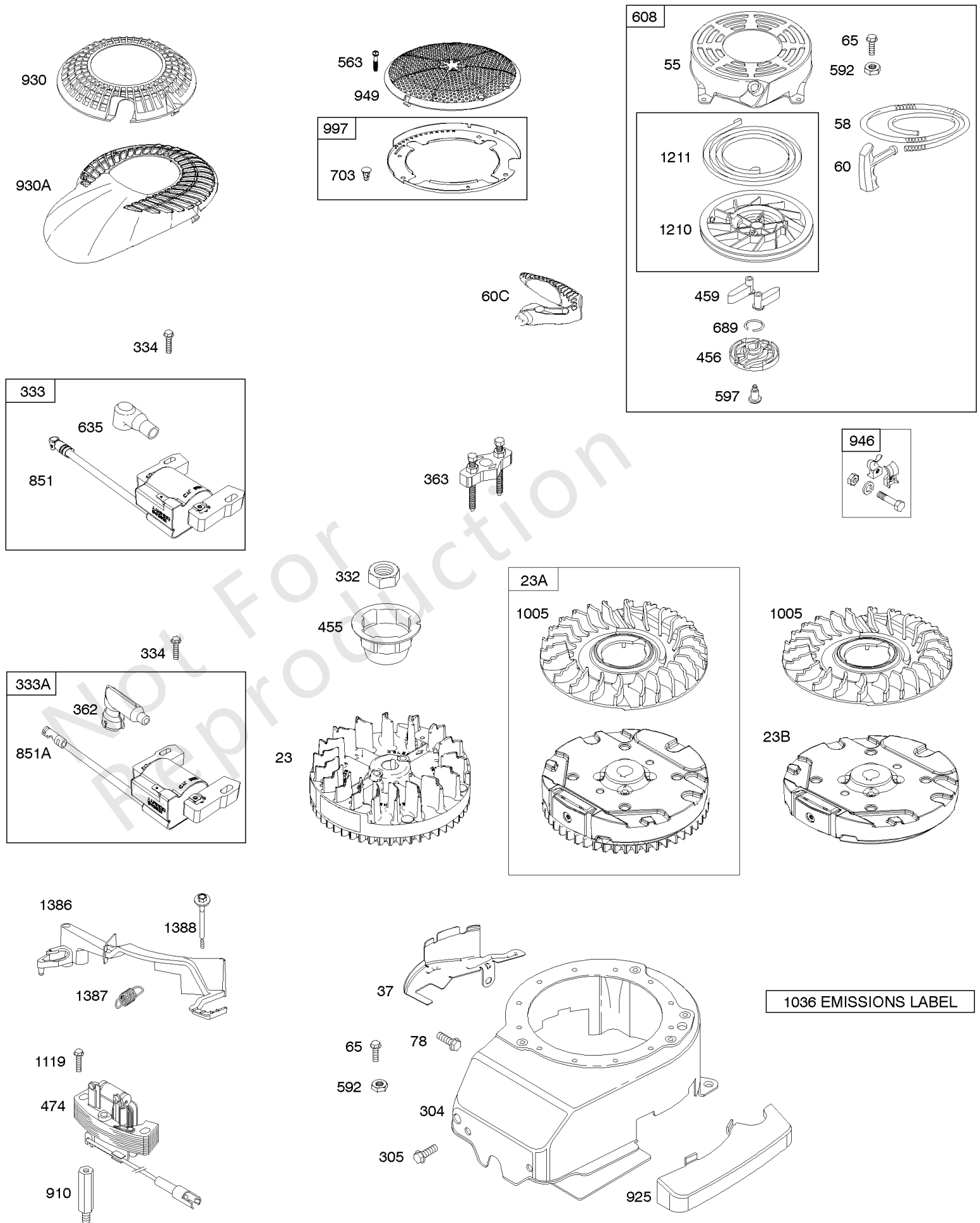

导风罩, 飞轮, 启动拉盘

参考编号	零件号	数量	描述
1386	790848		叶片, 空气 -自动阻风门系统 - 需要与替换电枢Ref # 333,590454一起使用
1387	790849		弹簧, 空气叶片
1388	790850		拧 - (风向标) (自动阻风门系统)

Not For Reproduction

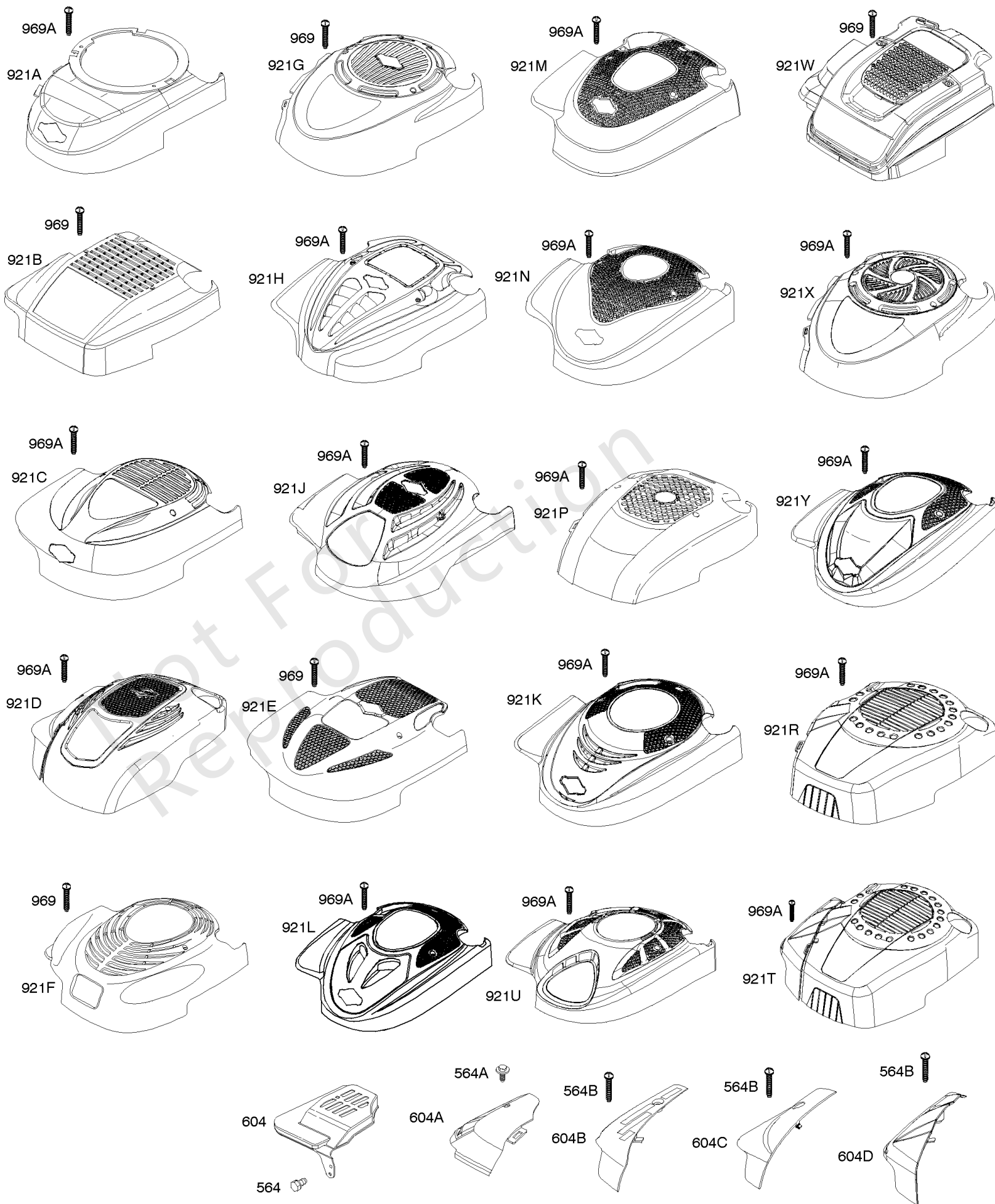

护罩

参考编号	零件号	数量	描述
564	690664		拧 - (控制盖)
564A	691142		拧 - (控制盖)
564B	698589		拧 - (控制盖)
604	691757		COVER-CONTROL
604A	691344		盖子, 控制
604B	790703		盖子, 控制
604C	792418		盖子, 控制
604D	793770		盖子, 控制 - (更换, 订单更换921T)
921A	695886		COVER-BLOWER HSG
921B	692931		壳, 导风罩
921D	591955		壳, 导风罩
921T	592290		壳, 导风罩
921C	695889		壳, 导风罩
921E	696262		壳, 导风罩
921F	697343		壳, 导风罩
921K	699984		壳, 导风罩
921J	790036		壳, 导风罩
921H	790037		壳, 导风罩
921L	791026		壳, 导风罩
921M	792652		壳, 导风罩
921N	792675		壳, 导风罩
921P	792687		壳, 导风罩
921R	793771		壳, 导风罩
921U	794355		壳, 导风罩
921G	795064		壳, 导风罩
921X	796706		壳, 导风罩
921W	796921		壳, 导风罩
921Y	798277		壳, 导风罩
969	690700		拧 - (导风罩房)
969A	691138		拧 - (导风罩房)

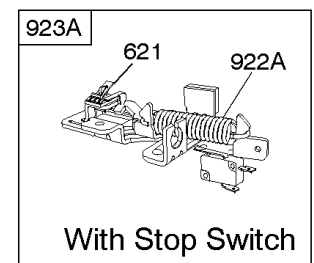
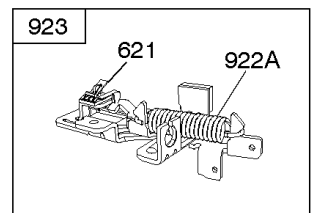
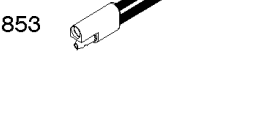
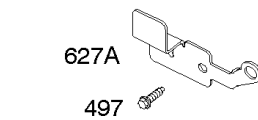
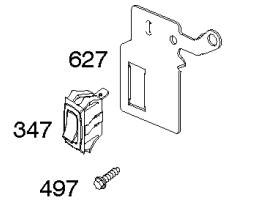
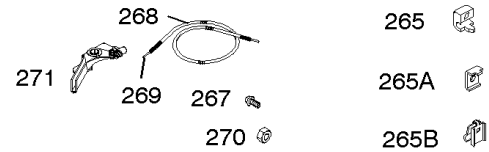
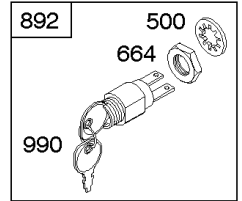
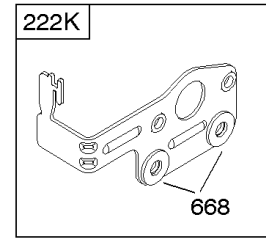
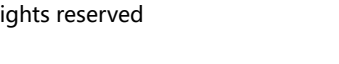
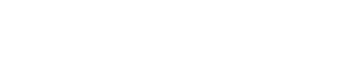
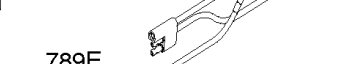
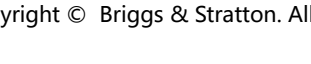
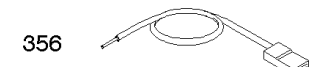
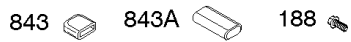
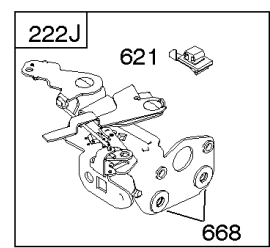
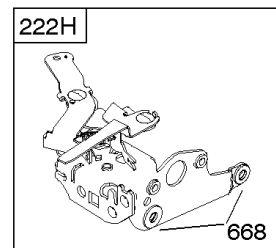
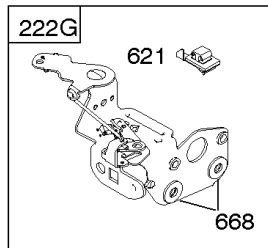
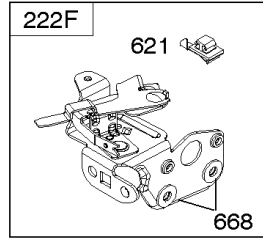
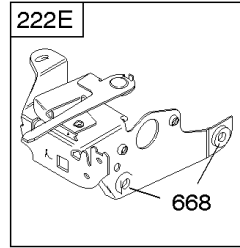
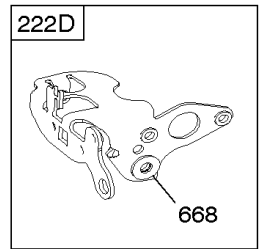
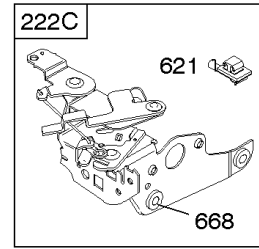
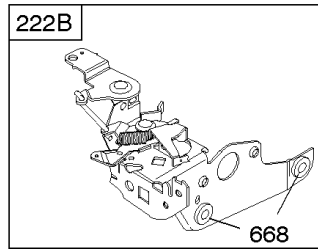
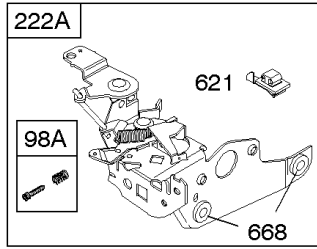
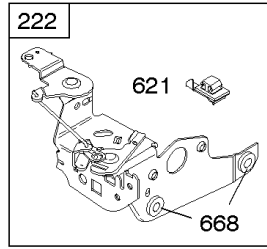

控制, 电气, 飞轮刹车, 调速弹簧

参考编号	零件号	数量	描述
98A	493280		KIT-IDLE SPEED - (怠速)
188	693399		拧 - (控制支架)
202	691829		连接, 机械调速器
209B	699056		调速斯普林
222K	593582		Bracket-Control
236	691826		链接, 锁定
265	690798		夹子, 线
265A	691024		夹子, 线
265B	692179		CLAMP-CASING
267	691044		拧 - (线夹)
268	691025		外壳, 控制线 - (切成所需长度)
269	691026		电线, 控制 - (切成所需长度)
270	691027		坚果 - (控制线套管)
271	691028		杠杆, 控制
347	691396		开关, 摇杆
356	692390		线, 停止
356B	693010		线, 停止
356D	496381		线, 停止
356H	690791		线, 停止
497	690664		拧 - (熄火开关支架)
500	691086		垫圈 - (钥匙开关)
578	398153		线组装
578A	695283		线组装
621	692310		转, 停
627	792565		BRACKET-STOPSWITCH
627A	793211		支架, 熄火开关
664	691087		坚果 - (钥匙开关)
668	493823		垫片 - (包括2)
745	691648		拧 - (刹车)
789A	696546		线束, 接线
789F	594393		线束, 接线
789B	792685		线束, 接线
789C	796385		线束, 接线
789D	796574		线束, 接线
789E	594392		线束, 接线
843	691884		衬套, 杠杆 - (速度控制)
843A	691895		衬套, 杠杆 - (呛)
853	695268		适配器, 电线
853A	695897		适配器, 电线
892	690646		开关, 钥匙
922A	692135		弹簧, 刹车
923	796136		刹车 - (自绕回弹开始)

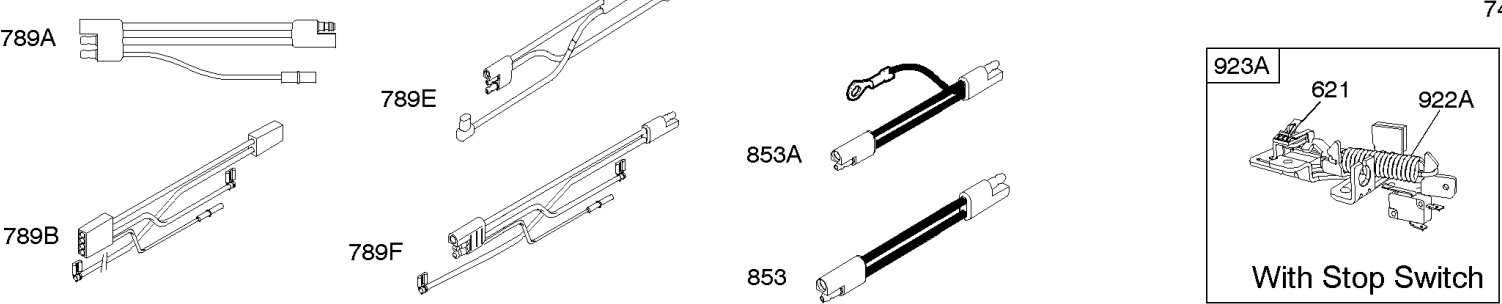
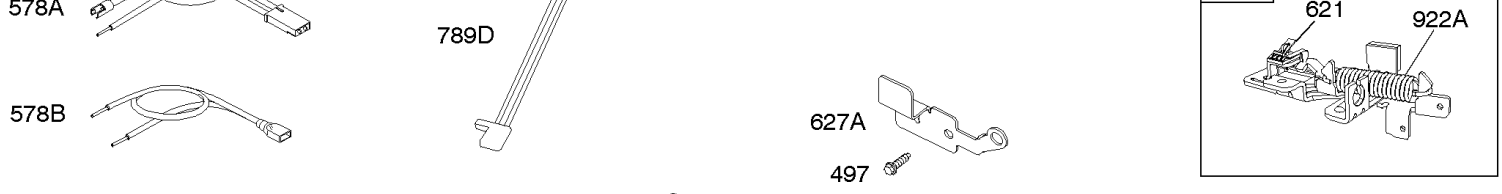
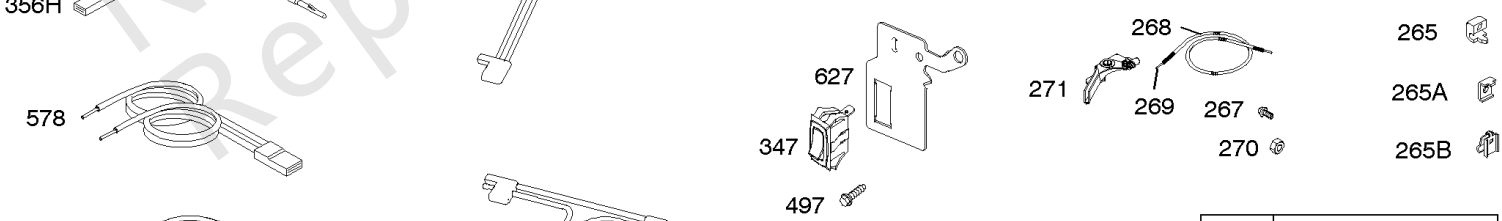
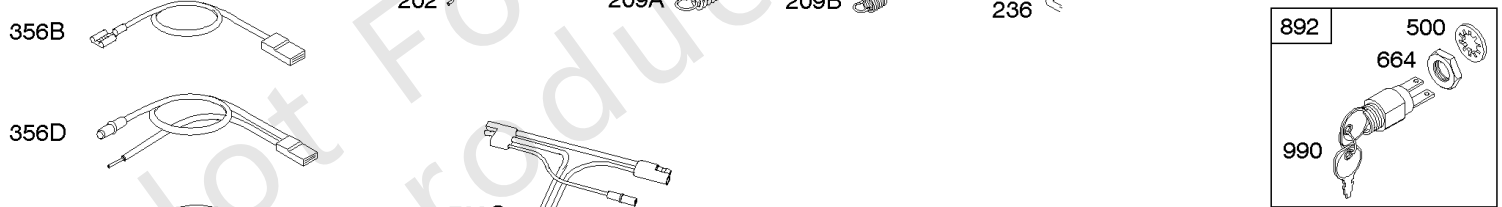
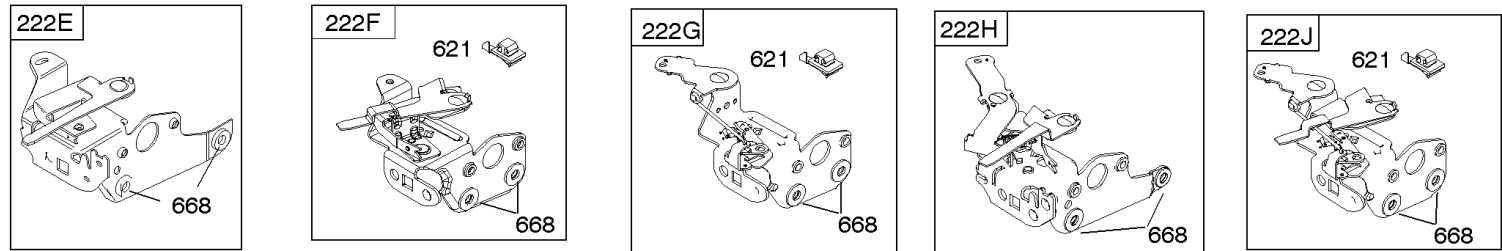
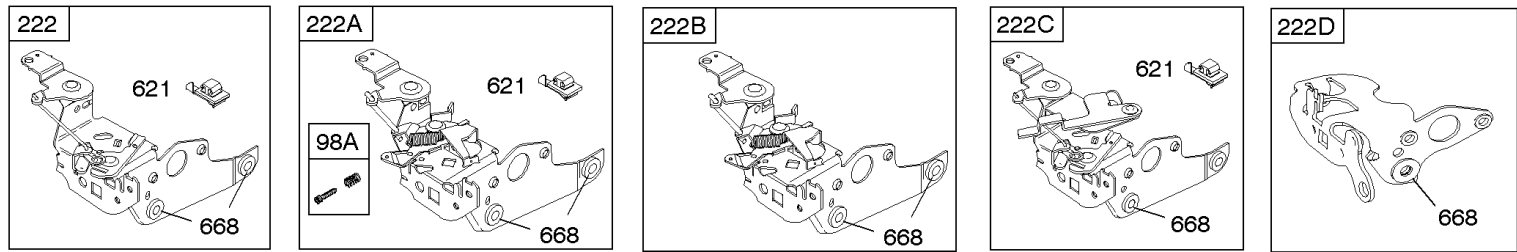

控制, 电气, 飞轮刹车, 调速弹簧

参考编号	零件号	数量	描述
923A	796387		刹车 - (电动启动)
990	691959		套装, Key

Not For Reproduction

替代发动机-美国和加拿大

参考编号	零件号	数量	描述
	126L021625	1	更换发动机
	792741	1	更换短块
	-----		Top No-Load Speed: 3100 -类型: 全部

Not For Reproduction

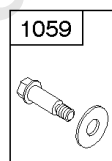
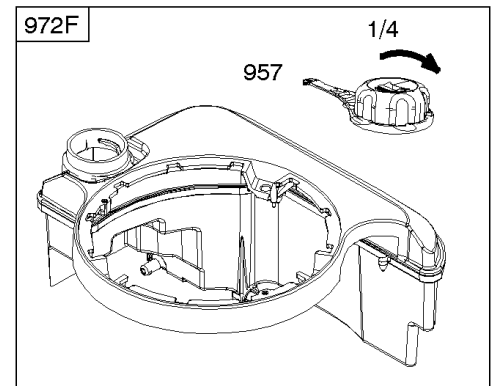
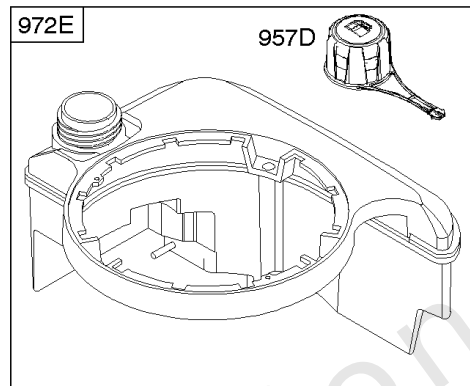
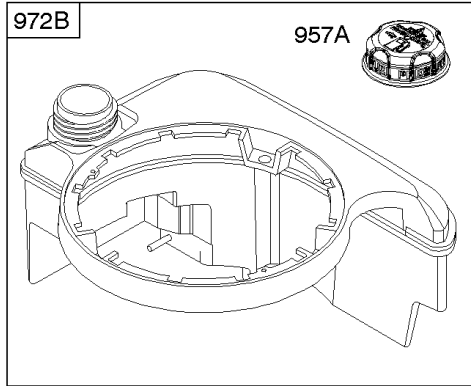
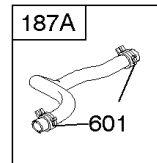
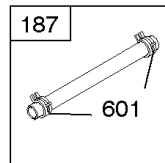
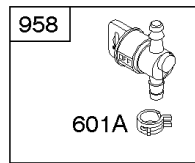
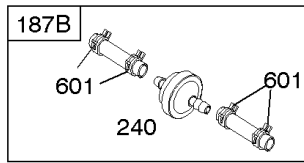

Not For
Reproduction

燃料供应, 点火

参考编号	零件号	数量	描述
187	791766		管, 燃油 - (15英寸长) (切成所需长度)
187A	791873		Line-Fuel - (成型)
187B	791891		Line-Fuel
190	690940		拧 - (油箱)
240	298090S		过滤器, 燃料
601	791850		夹子, 软管
601A	691038		夹子, 软管
670	692294		垫片, 油箱
957	591003		盖, 油箱 - (1/4转盖 - 红色)
957	799585		盖, 油箱 - (1/4转盖 - 黑色)
957A	692046		盖, 油箱 - (螺纹) (带通风口) 设定
957D	796577		帽燃油箱 - (螺纹) (带通风口) 设定
958	698183		阀门, 燃油关闭
972B	699374		油箱, 燃料 - (螺纹)
972F	590490		油箱, 燃料 - (1/4转盖 - 黑色)
972E	796578		油箱, 燃料 - (Flourinated)
1059	692311		套件, 螺丝/垫圈

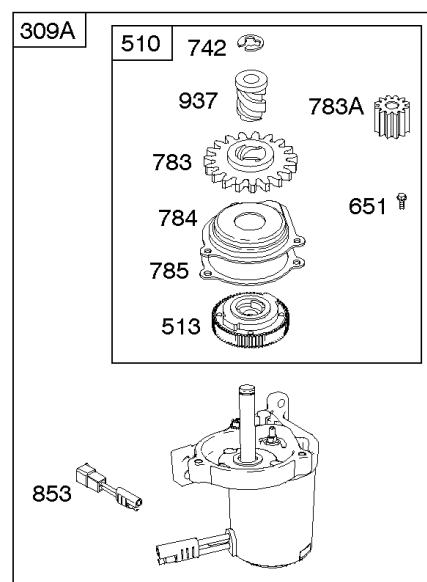
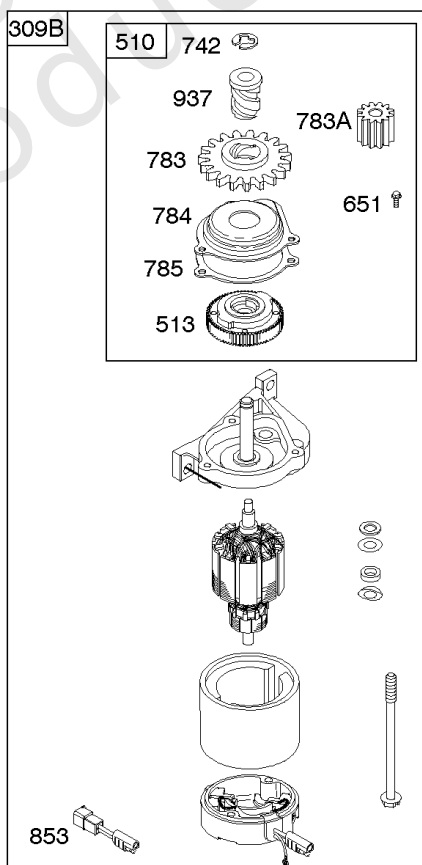
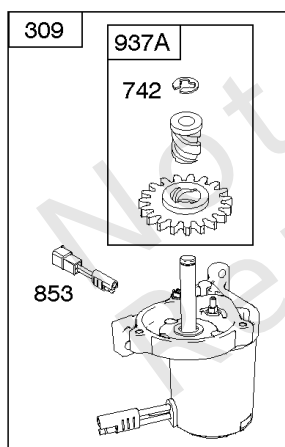
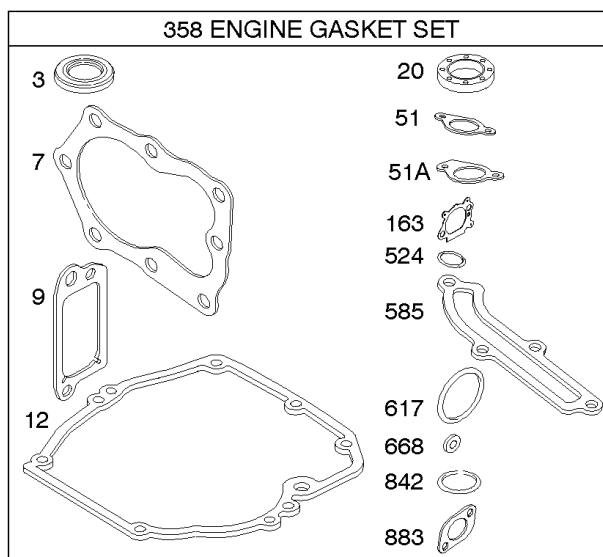
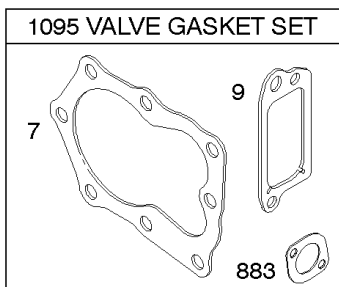
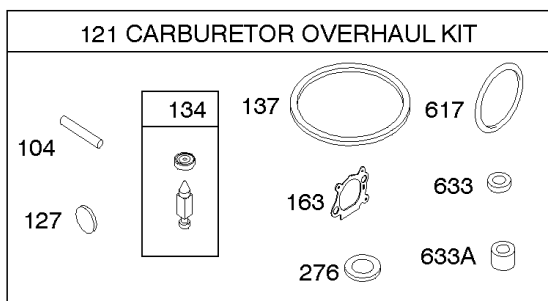

电启动器, 垫片套件

参考编号	零件号	数量	描述
3	299819S		海豹油 - (磁铁侧)
7	692249		垫片, 缸头 -在代码日期11070100 -之前使用
7	799875		垫片, 缸头 -在代码日期11063000 -之后使用
7	799874		垫片, 缸头
9	699833		GASKET-BREATHER
12	692232		垫片, 曲轴箱盖
20	399781S		海豹油 - (PTO方)
51	272199S		垫片, 进气管
51A	794306		垫片, 进气管
104	797622		Pin-Float Hinge
121	498260		套件, 化油器大修
127	694468		塞, 韦尔奇 - (碗通风口)
134	398188		套件-针/座
137	796610		垫片, 浮子碗 - (1/8)
137	693981		垫片 - 浮球碗 - (1/16)
163	795629		垫片 - 空气滤清器 - (空气滤清器)
276	271716		垫片用密封
309	799045		启动马达 -在代码日期10112700 -之后使用
309A	-----		启动马达 - (对于更换启动马达, 订货参考309)
309B	-----		启动马达 - (不再可用) (请参见参考309进行替换) 在代码日期07052800 -之后使用在代码日期10112800 -之前使用
358	590508		垫片包, 发动机
510	795093		驱动, 启动
513	795100		CLUTCH-DRIVE
524	692296		Seal-Dipstick Tube - (试纸管)
585	691879		GASKET-BREA PASSAGE
617	270344S		密封圈, O形圈 - (进气歧管)
633	691321		Seal-Choke/Thr Shaft - (节气门轴)
633A	693867		密封, 阻风门/节气门轴
651	691660		拧 - (起动机齿轮盖)
668	493823		垫片 - (包括2)
697	691127		拧 - (启动马达) (驱动器盖)
742	93941		固定器, E戒指
783	795099		GEAR-PINION
783A	795096		GEAR-PINION
784	795095		盖, 启动 齿轮
785	692352		GASKET-STARTER COVER

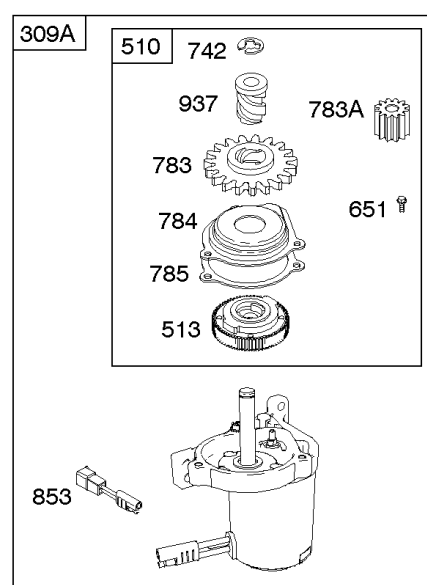
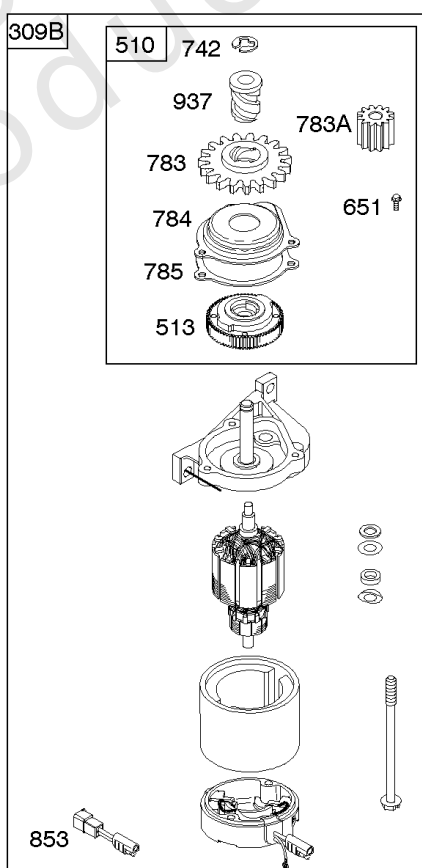
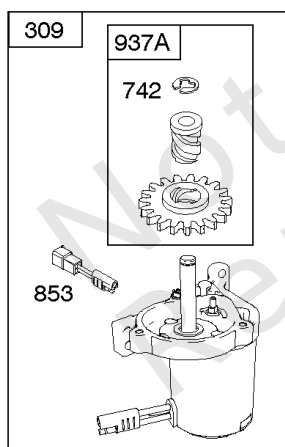
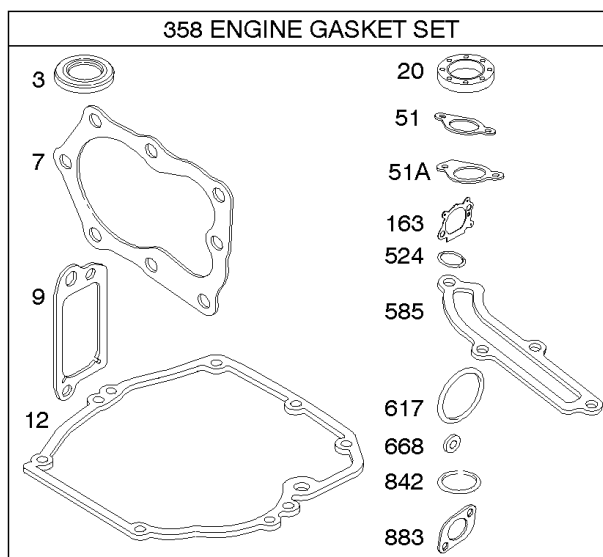
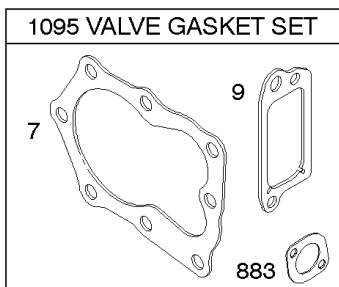
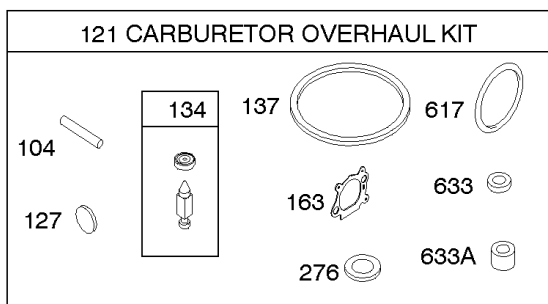

电启动器, 垫片套件

参考编号	零件号	数量	描述
842	691031		密封圈, O形圈 - (试纸管)
853	695268		适配器, 电线
883	691881		垫片, 排气
937	795098		SPLINE-STARTER
937A	799420		花键, 启动
1095	590507		垫片包, 阀门

Not For Reproduction

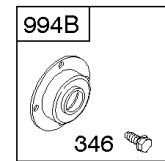
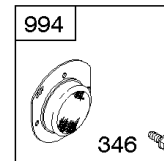
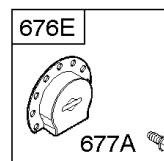
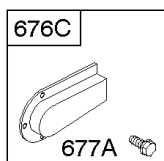
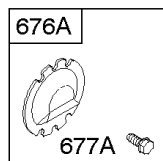
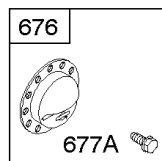
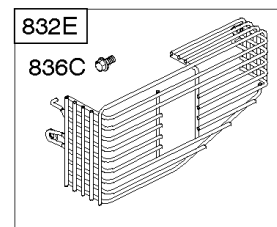
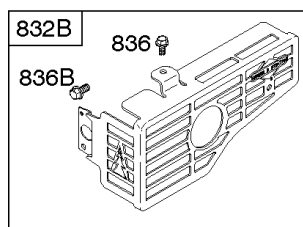
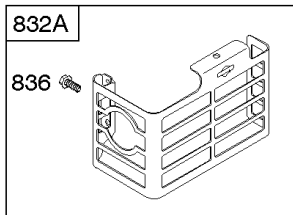
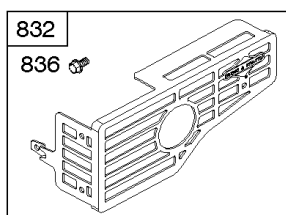
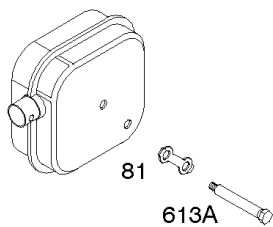
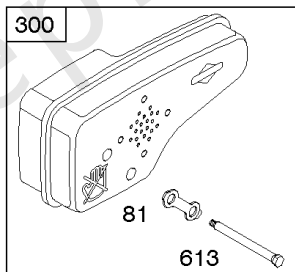
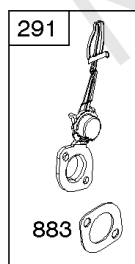
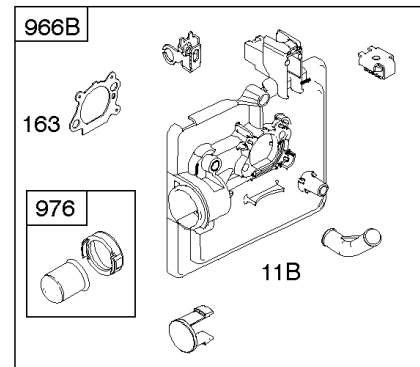
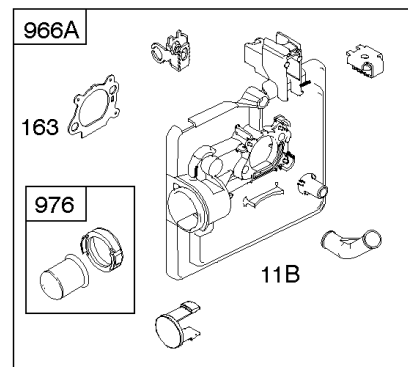
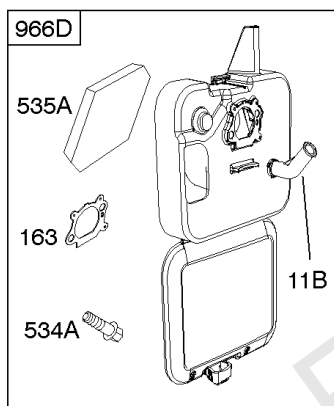
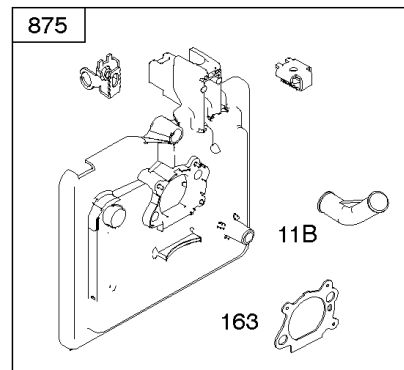
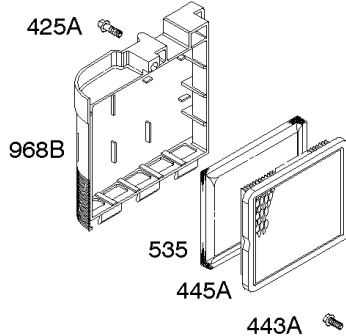
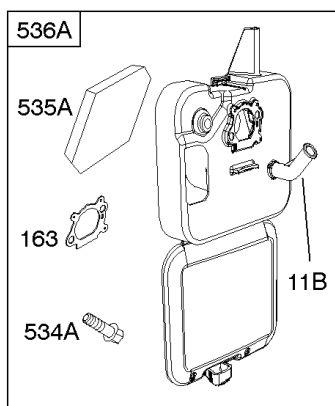

空气滤清器, 排气系统

参考编号	零件号	数量	描述
11B	691923		管子, 呼吸器
81	691740		锁, 消音器螺丝
163	795629		垫片 - 空气滤清器 - (空气滤清器)
291	593208		温控器
300	593581		围巾 - (准备启动系统) 在代码日期13122200 -之后使用
300	790828		围巾 -在代码日期13122300 -之前使用
346	690661		拧 - (火花捕捉器)
425A	690670		拧 - (空气滤清器盖)
443A	692523		拧 - (空气滤清器底漆基地)
445A	491588S		过滤器, 空气滤清器盒
534A	798294		拧 - (空气滤清器)
535	493537S		过滤器, 空气过滤器泡沫
536A	798293		清洁剂, 空气
613	691340		拧 - (消音器) (1 / 4-20 x 2.75英寸总长度, 2.25英寸肩长)
613	790833		拧 - (消音器) (1 / 4-20 x 2.75英寸总长度, 2.08英寸肩长)
613	792678		拧 - (消音器) (1 / 4-20 x 3.39英寸总长度, 2.71英寸肩长)
613A	691653		拧 - (消音器) (1 / 4-20 x 3.39英寸总长度, 2.88英寸肩长)
676	396548		消除器, 消音器
676A	393756		消除器, 消音器 - (侧面插座)
676C	493871		消除器, 消音器
676E	393760		消除器, 消音器
677	690661		拧 - (消音器导流器) (螺纹成型)
677A	593440		拧 - (消音器导流板) (自钻和攻丝)
832	593875		保护, 围巾
832A	691424		围巾
832B	497683		保护, 围巾
832E	793568		围巾
836	690664		拧 - (消音器卫队)
836B	691147		拧 - (消音器卫队)
836C	790745		拧 - (消音器卫队)
883	691881		垫片, 排气
966A	593942		底座, 空气滤清器 - (引物) (2点安装) 在代码日期14012600 -之后使用
966D	593945		底座, 空气滤清器 - (引物) 在代码日期14012600 -之后使用
966B	795259		BASE-AIR CLEANER PRIM - (底漆) (3点安装) 代码日期14012700 -之前使用

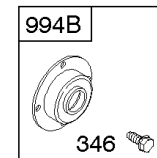
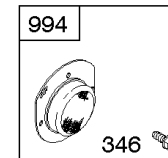
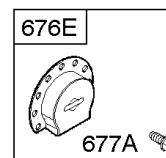
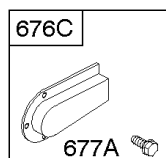
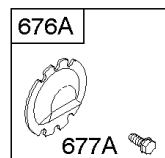
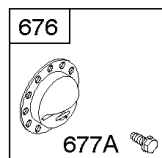
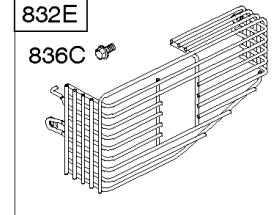
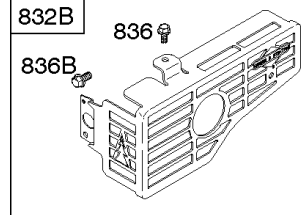
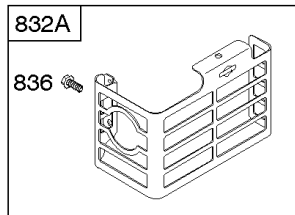
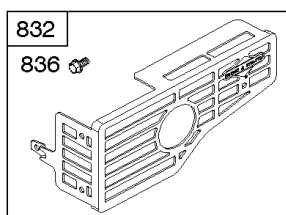
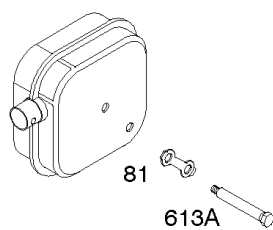
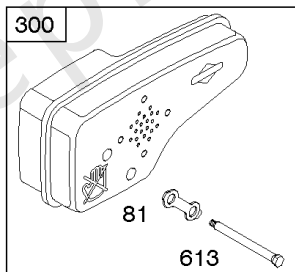
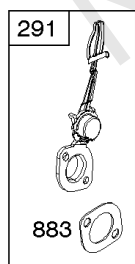
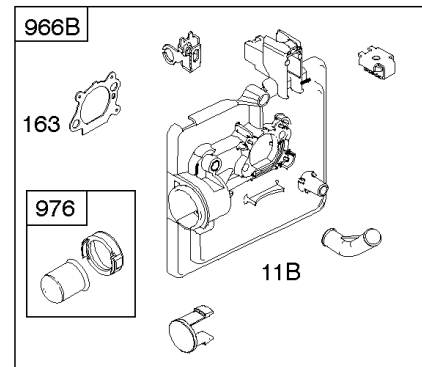
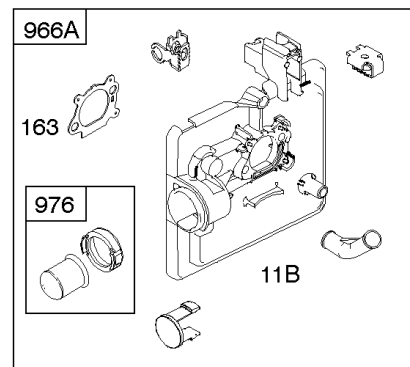
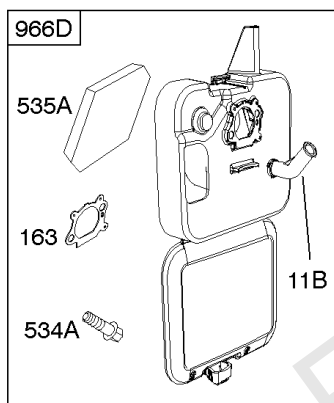
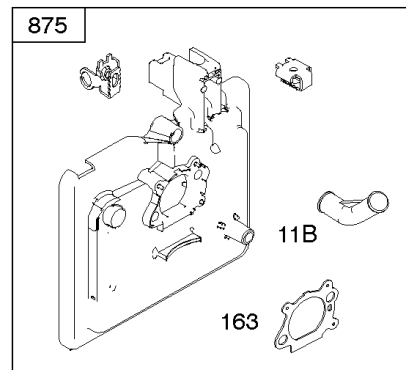
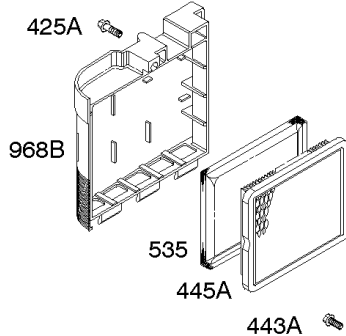
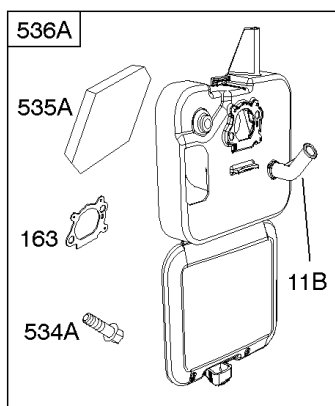

空气滤清器, 排气系统

参考编号	零件号	数量	描述
968B	692298		盖子, 空气滤清器
976	694395		泵油, 化油器
994	398067		ARRESTOR-SPARK
994B	792245		捕捉器, 火花

Not For Reproduction

