



Parts Manual

Mfg. No: 060501-9410-24

Model Components	Page
Blower Hsgs,Rewind Starters.....	4
Carburetors,AirCleaners,Fuel.....	6
Cylinder,Sump Base,PistonGrp.....	10
Replacement Engine - US & Canada.....	18

Not For
Reproduction

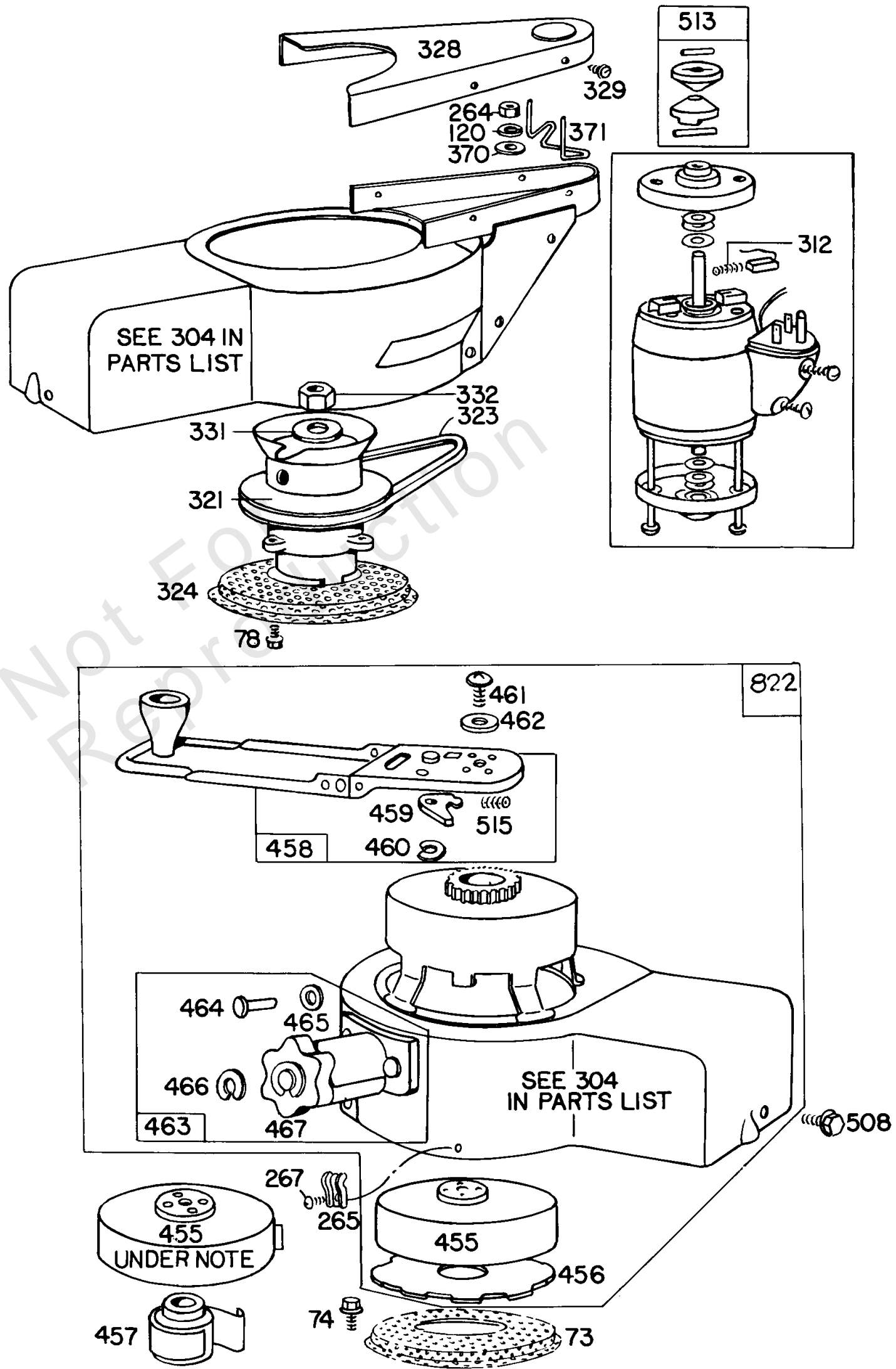

Blower Hsgs,Rewind Starters

REF NO	PART NO	QTY	DESCRIPTION
73	220648		SCREEN, Rotating
74	93042		SCREW
78	93705		SCREW -(8-32 X 3/8)
120	92290		WASHER
264	90355		NUT, Hex
265	221407		CLAMP, Casing
267	93067		SCREW -(3/8)
304	294263		HOUSING, Blower -(Rope Starter)
312	260404		SPRING, Brush
321	210711		PULLEY, Starter -(Fits Crankshafts With 1/2-20 Thread) When ordering this pulley, order Vee-Belt part No. 67238 also.
323	67028		BELT, Vee -Used Before Code Date 5903020
323	67238		BELT, Vee
324	220648		SCREEN, Rotating
328	221039		GUARD, Belt
329	93705		SCREW -(8-32 X 3/8)
331	62577		WASHER -(1/2 Hole)
332	91708		NUT -(1/2-20 L.H. Thread)
370	66432		WASHER
371	260275		GUARD, Belt
455	296455		CUP, Flywheel -(With Pinned Spring)
456	221222		PLATE, Retainer
457	296264		SPRING, Rewind Starter -Used on earlier model engines
458	298431		HANDLE, Cranking
459	221220		PAWL, Ratchet -Used on earlier model engines. (Double Acting) Used on earlier model engines
459	221332		PAWL, Ratchet
460	93272		RETAINER, E Ring
461	93298		SCREW
462	221237		WASHER
463	296445		HOUSING, Flywheel
464	93291		RIVET -(2)
465	221226		WASHER
466	93272		RETAINER, E Ring
467	211017		KNOB, Air Cleaner Cover
508	93294		SCREW -(5/8)
513	296567		CLUTCH, Starter
515	260537		SPRING, Ratchet
822	297518		STARTER SUB ASSEMBLY

Footnotes:

Cables used on and after this serial number are molded into the coil.

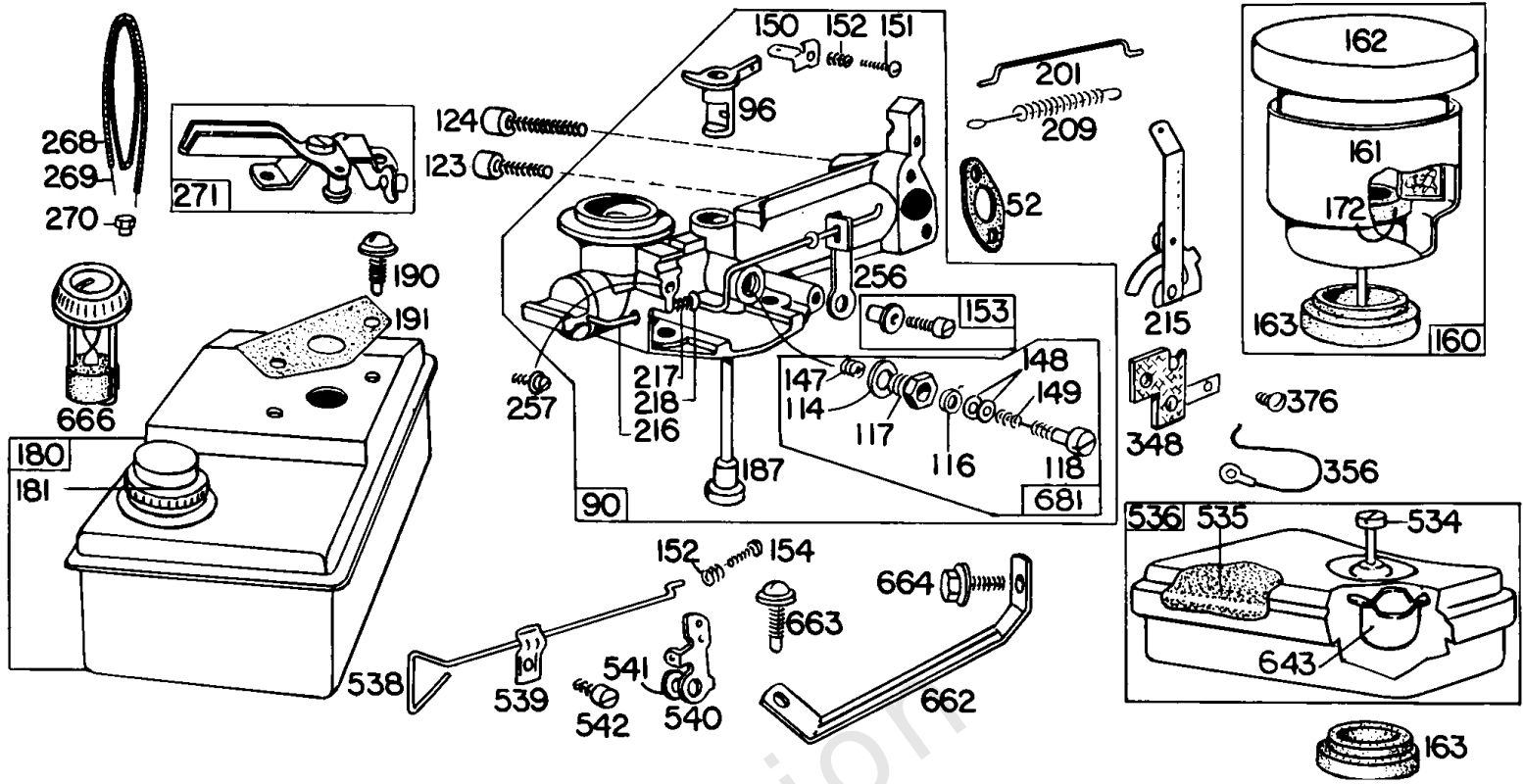

Carburetors, Air Cleaners, Fuel

REF NO	PART NO	QTY	DESCRIPTION
52	27355		GASKET, Intake -(2) Included in Gasket Set-Part No. 297275
90	295276		CARBURETOR -(Manual Choke)
96	210721		LINK, Throttle
114	65787		SEAT, Needle Valve -Included in Needle Valve Kit-No. 299059
116	65978		SEAL, O-Ring -(Needle Valve) Included in Needle Valve Kit-No. 299059
117	23431		NUT, Needle Valve -Included in Needle Valve Kit-No. 299059
118	23433		VALVE, Float Needle -Included in Needle Valve Kit-No. 299059
123	93357		SCREW
124	93360		SCREW -(Carburetor)
147	23432		SEAT, Needle Valve -Included in Needle Valve Kit-No. 299059
148	22235		WASHER -Included in Needle Valve Kit-No. 299059
149	26336		SPRING, Needle Valve -Included in Needle Valve Kit-No. 299059
150	220105		LINK, Mechanical Governor
151	93527		SCREW -(5-40 X 5/8)
152	260575		SPRING, Throttle Return
153	298031		SCREW -(Carburetor Lever)
154	93349		SCREW
160	294870		CLEANER, Air -(With Mounting Stud)
161	293991		CLEANER, Air
162	294861		COVER, Air Cleaner -(With Mounting Stud)
163	27660		GASKET, Air Cleaner -Included in Gasket Set-Part No. 297275
172	27795		GASKET, Air Cleaner -(Air Cleaner)
180	293630		TANK, Fuel
181	298425		CAP, Fuel Tank -(Metal)
187	296476		TUBE, Pick Up -(Used To Replace Plastic Pipes) Used to replace Plastic Pipes. Use: 293700 Pipe-Fuel to replace 2-17/32 long brass pipes.
187	296842		LINE, Fuel -Use: 295121 Pipe-Fuel to replace 2-9/32 long brass pipes. Used to replace 2-11/32 long plastic pipes.
190	93259		SCREW -(Fuel Tank)
191	27404		GASKET, Fuel Tank -Included in Gasket Set-Part No. 297275
201	260024		LINK, Choke
209	260025		SPRING, Governor -(Manual Choke)
215	220107		LEVER, Speed Adjuster

Footnotes:

Cables used on and after this serial number are molded into the coil.

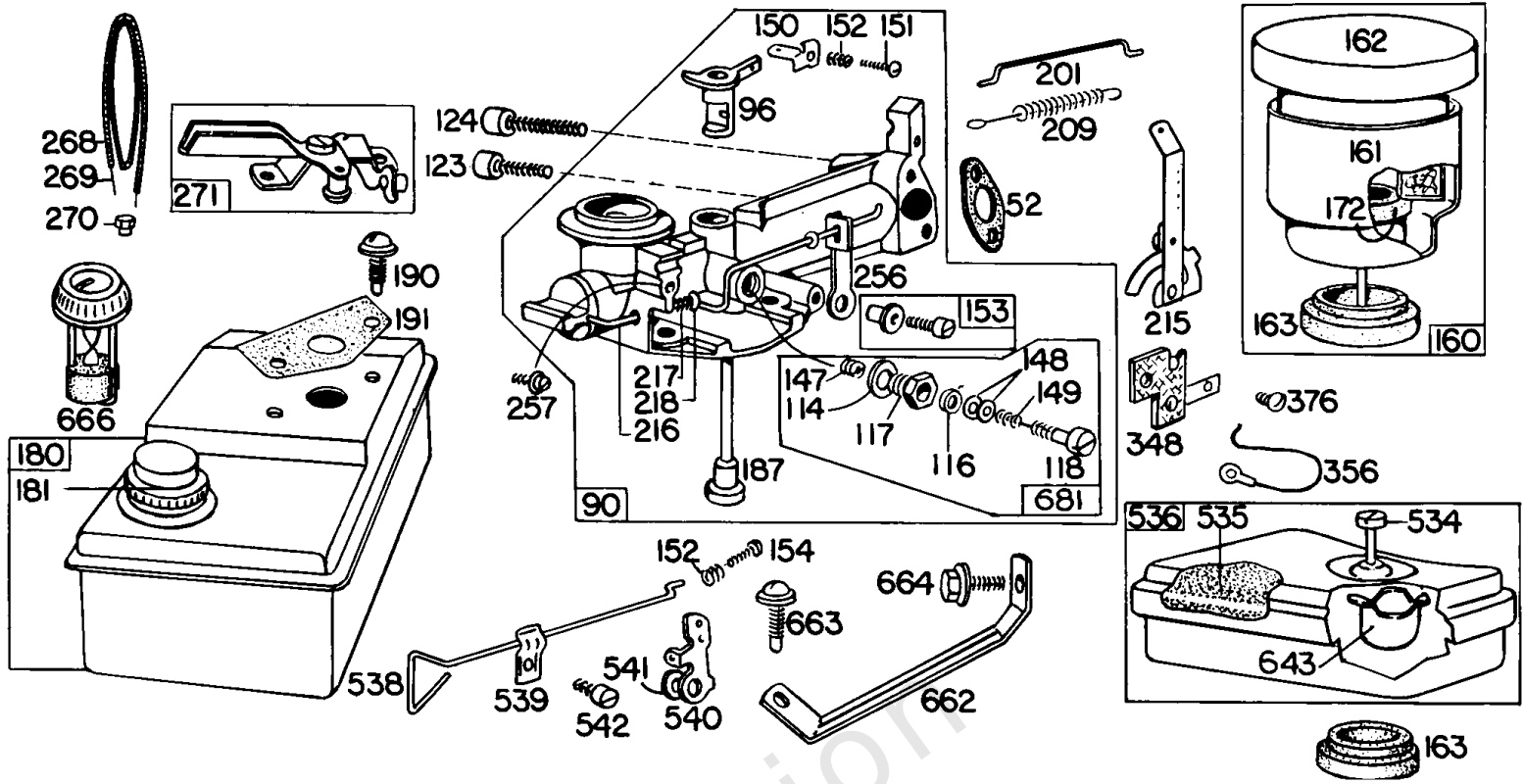

Not For
Reproduction

Carburetors, Air Cleaners, Fuel

REF NO	PART NO	QTY	DESCRIPTION
215	293424		LEVER, Governor Control
216	260188		LINK, Choke
217	260189		SPRING, Friction
218	220968		WASHER -(Choke Link)
256	220952		LEVER, Speed Adjuster
257	93263		SCREW -(10-32 X 3/8)
268	66986		CASING, Control Wire -(Cut To Required Length)
269	26099		WIRE, Control -(Cut To Required Length) If longer wire is needed, specify length in inches; if shorter wire is needed, order No. 26099 and cut to required length.
270	63426		NUT -(Control Wire Casing)
271	290568		LEVER, Control
348	296110		SWITCH, Stop
356	296185		WIRE, Stop
376	93167		SCREW
534	93322		SCREW -(1 15/16)
535	27987		FILTER, Air Cleaner Foam
536	296766		CLEANER, Air
538	260560		ROD, Governor Control
540	221380		LEVER, Control
541	22398		WASHER
542	91494		SCREW -(10-32 X 3/8)
643	221321		CUP, Air Cleaner
662	298081		BRACKET, Support
663	93259		SCREW -(Fuel Tank)
664	93415		SCREW -(1/4-20 X 3/4)
666	297073		GAUGE, Fuel
681	299059		KIT, Needle Valve

Footnotes:

Cables used on and after this serial number are molded into the coil.

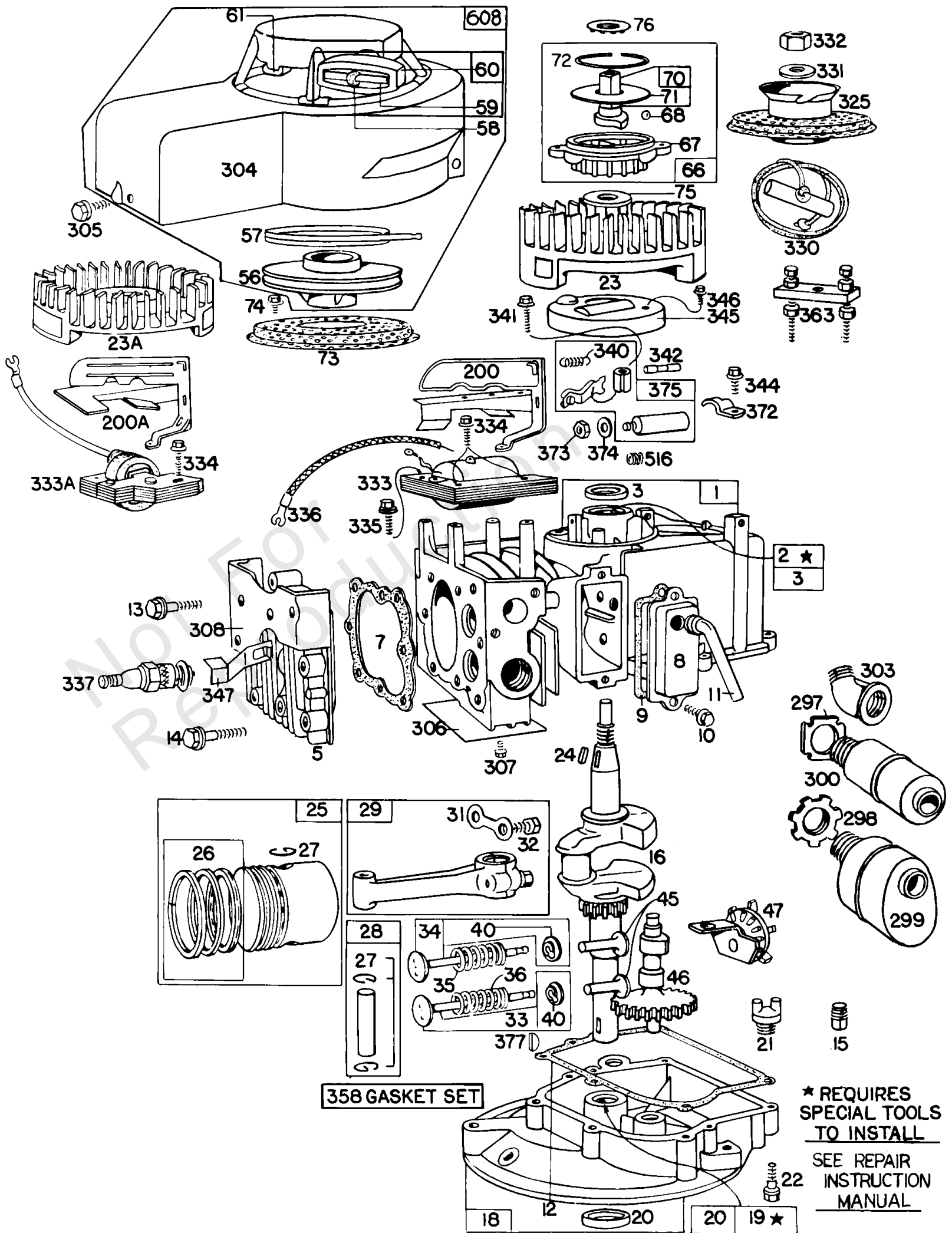

Cylinder,Sump Base,PistonGrp

REF NO	PART NO	QTY	DESCRIPTION
1	293511		CYLINDER ASSEMBLY -Used Before Code Date 5810060
1	295450		CYLINDER ASSEMBLY -Used After Code Date 581030
2	293708		KIT, Bushing/Seal -(Plain Bearing)
3	299819		SEAL, Oil -(Plain Bearing)
5	210209		HEAD, Cylinder -Used Before Code Date 5810060
7	27670		GASKET, Cylinder Head -Included in Gasket Set-Part No. 297275
8	292833		BREATHER ASSEMBLY
9	27549		GASKET, Rocker Cover -Included in Gasket Set-Part No. 297275
10	93394		SCREW
11	294032		TUBE, Breather -(with Spacer)
11	66638		TUBE, Breather
12	270833		GASKET, Crankcase -(.015) Included in Gasket Set-Part No. 297275
12	270895		GASKET, Crankcase -(.005) Included in Gasket Set-Part No. 297275
12	270896		GASKET, Crankcase -(.009) Included in Gasket Set-Part No. 297275
13	93111		SCREW -(15/16)
14	93113		SCREW -(2 5/16) (2-5/16)
15	91084		PLUG, Oil Drain -(3/8)
16	26976		CRANKSHAFT
18	293512		SUMP, Engine
19	293709		KIT, Bushing/Seal -(PTO Side)
20	391483		SEAL, Oil -(PTO Side)
21	66768		PLUG, Oil
22	93032		SCREW -(Fuel Tank) (Tank)
23A	297949		FLYWHEEL -Used After Code Date 6212310
23	293205		FLYWHEEL -Used Before Code Date 6212310
24	61760		KEY, Flywheel -(Breaker Ignition)
25	293400		PISTON ASSEMBLY -(2-5/16 Bore) -Used Before Code Date 5810060
25	293401		PISTON ASSEMBLY -(2-5/16 Bore) -Used Before Code Date 5810060
25	293402		PISTON ASSEMBLY -(2-5/16 Bore) -Used Before Code Date 5810060
25	293403		PISTON ASSEMBLY -(2-5/16 Bore) -Used Before Code Date 5810060

Footnotes:

Cables used on and after this serial number are molded into the coil.

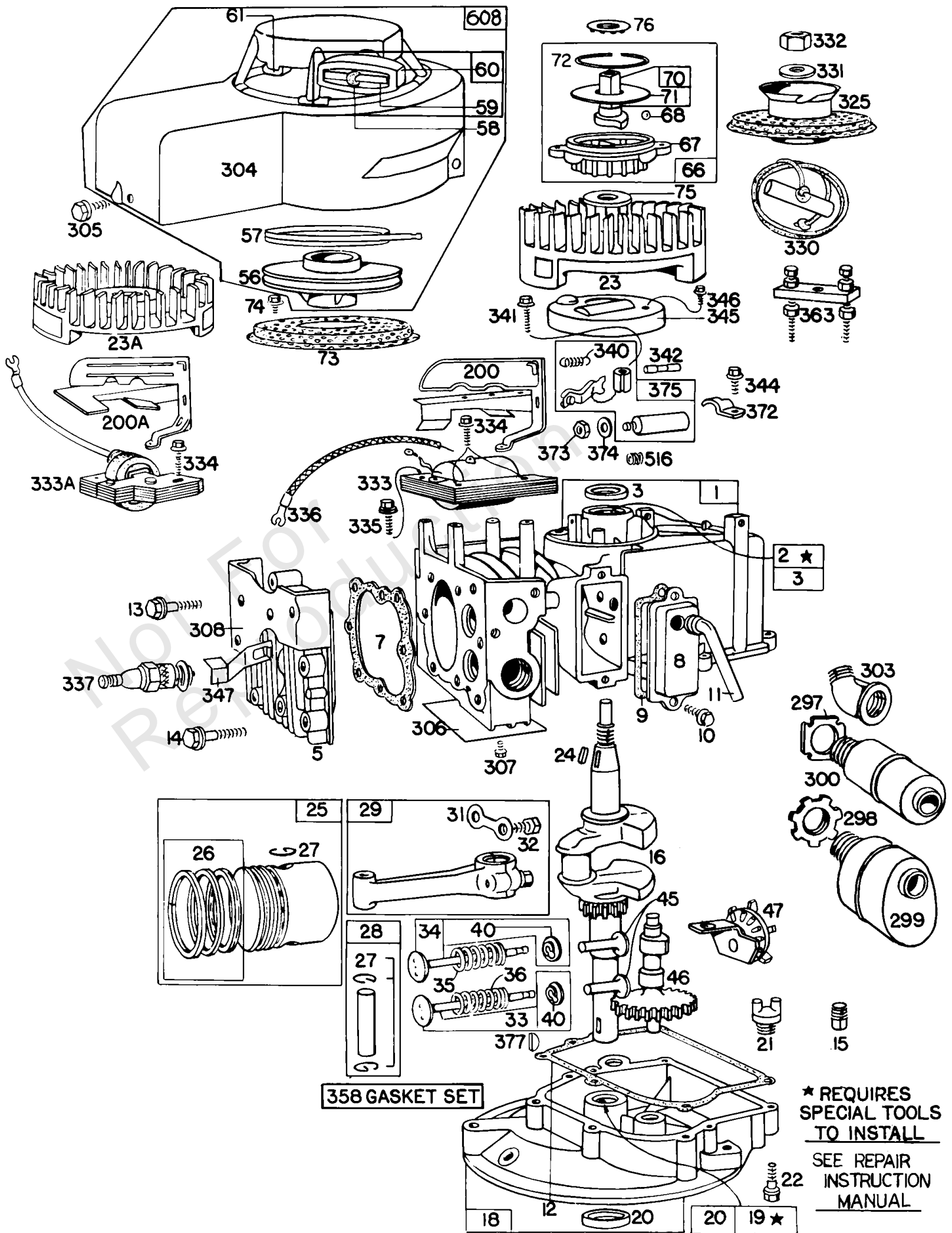

Cylinder,Sump Base,PistonGrp

REF NO	PART NO	QTY	DESCRIPTION
25	295587		PISTON ASSEMBLY -Used After Code Date 5810030
25	295588		PISTON ASSEMBLY -(2-3/8 Bore) -Used After Code Date 5810030
25	295589		PISTON ASSEMBLY -(2-3/8 Bore) -Used After Code Date 5810030
25	295590		PISTON ASSEMBLY -(2-3/8 Bore) -Used After Code Date 5810030
26	293506		SET, Ring -Used Before Code Date 5810060
26	293507		SET, Ring -(.010 Oversize) -Used Before Code Date 5810060
26	293508		SET, Ring -(.020 Oversize) -Used Before Code Date 5810060
26	293509		SET, Ring -(.030 Oversize) -Used Before Code Date 5810060
26	294224		SET, Ring -(.010 Oversize) -Used After Code Date 5810030
26	294225		SET, Ring -(.020 Oversize) -Used After Code Date 5810030
26	294226		SET, Ring -(.030 Oversize) -Used After Code Date 5810030
26	294232		SET, Ring -Used After Code Date 5810030
27	26026		LOCK, Piston Pin
28	298908		PIN, Piston -(.005 Oversize)
28	298909		PIN, Piston
29	293505		ROD, Connecting
31	220460		LOCK, Rod Screw
32	92296		SCREW -(Connecting Rod)
33	296676		VALVE, Exhaust -(Grooved Stem-Includes Retainer)
34	23386		VALVE, Intake -(With Hole In Stem) -Used Before Code Date 5810060
35	260552		SPRING, Valve -(Exhaust)
36	26478		SPRING, Valve -(Exhaust)
40	23184		RETAINER, Valve
40	23187		PIN, Locating -(Use with valves with hole in stem except with rotocap)
40	93312		RETAINER, Valve -(Valves With Groove In Stem)
45	230173		TAPPET, Valve
46	210453		CAMSHAFT

Footnotes:

Cables used on and after this serial number are molded into the coil.

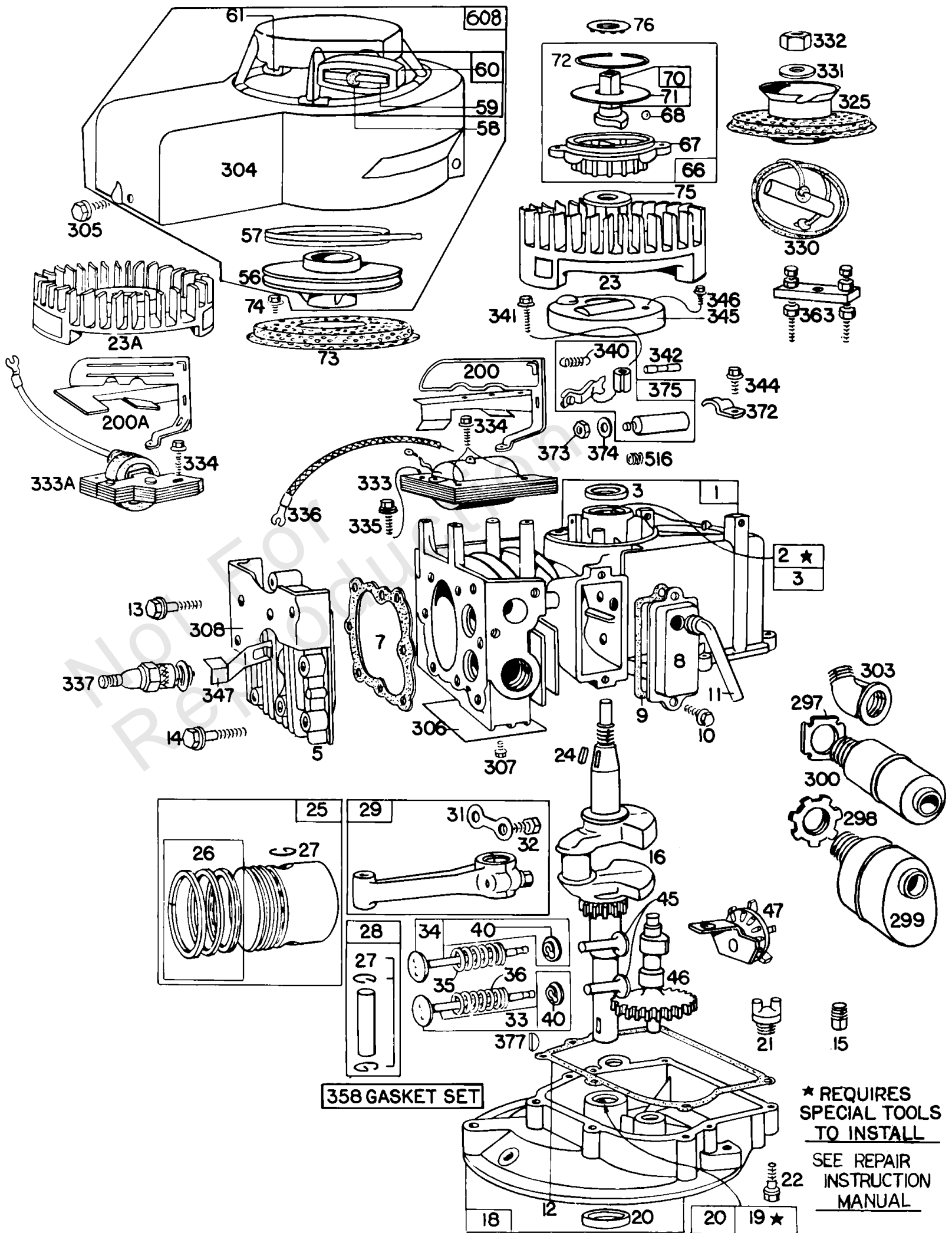

Cylinder,Sump Base,PistonGrp

REF NO	PART NO	QTY	DESCRIPTION
47	294652		SLINGER, Governor/Oil
56	294088		PULLEY, Starter
57	294303		SPRING, Rewind Starter
58	294584		ROPE, Starter -(47-1/8) If longer rope is needed, order No. 66514 and cut to required length.
59	230228		PIN, Starter Grip
60	393152		GRIP-STARTER ROPE
61	68618		BUMPER, Starter Pulley -(Used with Steel Pulley only)
66	298798		CLUTCH, Starter -(Rewind Starter) Uses: 212132 Housing-Starter Clutch 66718 Washer-Thrust 298799 Ratchet Assy. 221653 Washer-Clutch
67	210400		HOUSING, Clutch
68	63770		BALL, Clutch
70	296597		RATCHET, Clutch
71	221301		WASHER
72	26032		RETAINER
73	220648		SCREEN, Rotating
74	93042		SCREW
75	220865		WASHER -(Heavy Flywheel)
76	66738		WASHER, Sealing -(Used only with 7 point shank ratchet)
200A	297309		BLADE, Governor -Used After Code Date 6212310
200	294617		BLADE, Governor -Used Before Code Date 6212310
297	91811		LOCKNUT -(Elbow)
298	220859		LOCKNUT -(Muffler and Elbow)
299	392811		MUFFLER -(Lo Tone)
300	89966		MUFFLER
304	294263		HOUSING, Blower -(Rope Starter)
305	93158		SCREW -(1/4-20 X 5/8)
306	220478		SHIELD, Cylinder
307	93042		SCREW
308	220581		COVER, Cylinder Head
325	293959		PULLEY, Rope Starter -(1/2 Hole In Pulley)
330	294584		ROPE, Starter -(47-1/8)
331	62577		WASHER -(1/2 Hole)
332	91708		NUT -(1/2-20 L.H. Thread)
333A	298502		ARMATURE, Magneto -(Points And Condenser) -Used After Code Date 6212310
333	291617		ARMATURE, Magneto -Used Before Code Date 6212310

Footnotes:

Cables used on and after this serial number are molded into the coil.

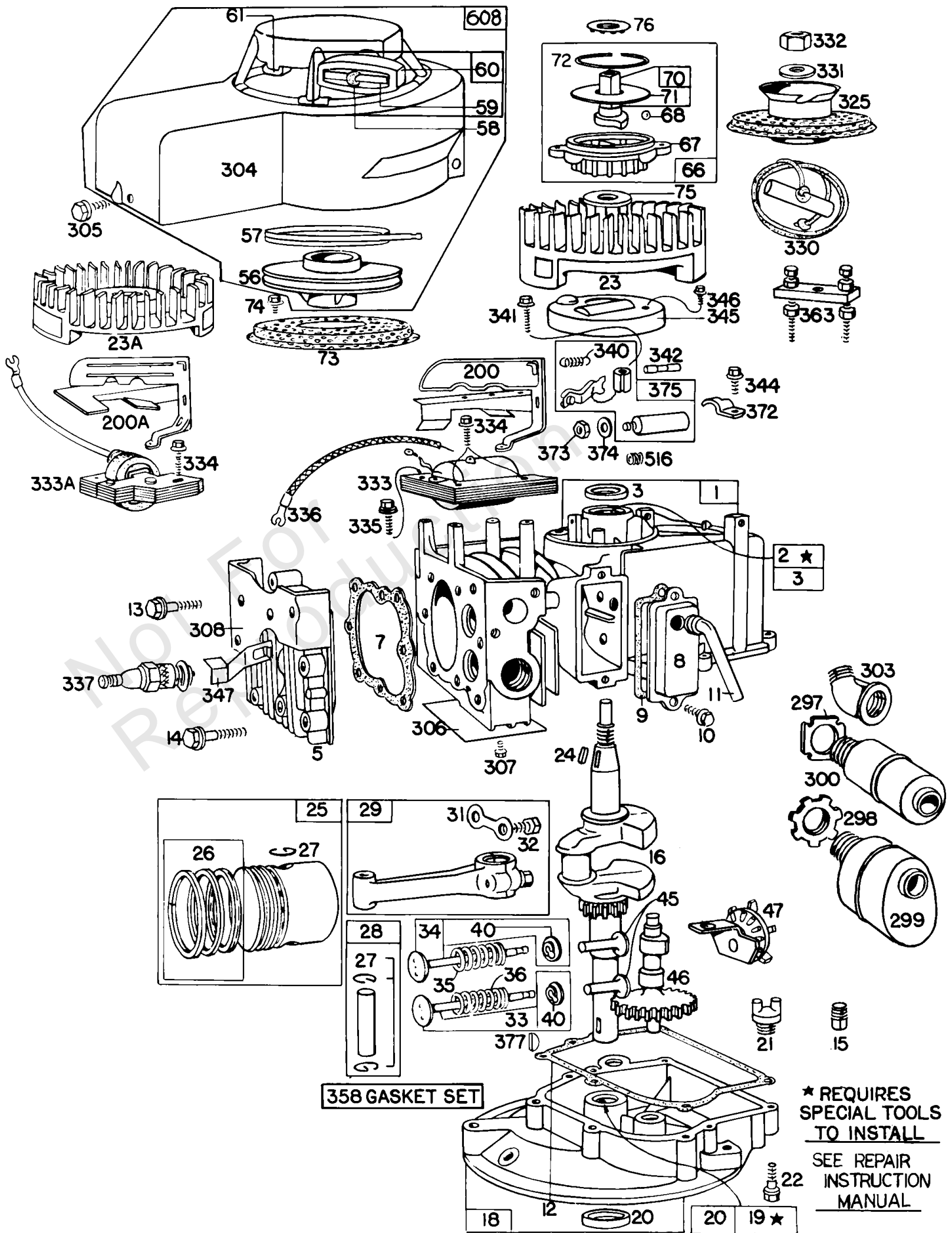

Cylinder, Sump Base, Piston Grp

REF NO	PART NO	QTY	DESCRIPTION
334	93381		SCREW
335	93381		SCREW
336	292149		CABLE, Ignition -Used Before Code Date 6212310
337	29693		PLUG, Spark
340	26018		SPRING, Breaker Arm
341	93381		SCREW
342	65704		PLUNGER, Breaker
344	93042		SCREW
345	220366		COVER, Breaker
346	93705		SCREW -(8-32 X 3/8)
347	221808		SWITCH, Stop
358	297275		GASKET SET, Engine -(Used with Rotary Choke Carburetors)
363	19069		PULLER, Flywheel
372	220477		CLAMP
373	92987		STARTER, Rewind
374	92813		WASHER
375	293999		STRAP, Ground
375	294628		BREAKER, Ignition
375	90072		SCREW -(8-32 X 5/8)
375	90576		NUT -(Ground Terminal)
375	92791		WASHER
377	93065		KEY, Woodruff -(#6)
516	260374		SPRING, Condensor
608	294259		HOUSING, Blower -(10 O'clock)

Footnotes:

Cables used on and after this serial number are molded into the coil.

Replacement Engine - US & Canada

REF NO	PART NO	QTY	DESCRIPTION
	10T8020015	1	Replacement Engine
	-----		Service Note: Replacement engine listed is not available in the State of California. Repair with individual parts.

Not For Reproduction

