

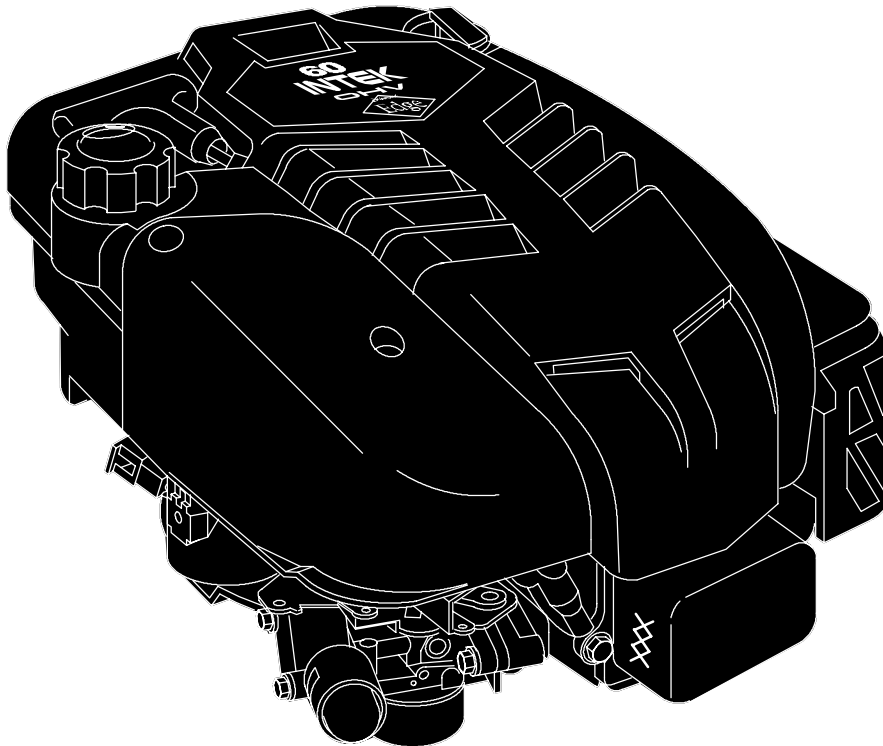

The Power That Works For You.®

# Operating & Maintenance Instructions





Model 110000 120000 Series covered in this manual

---

[www.briggsandstratton.com](http://www.briggsandstratton.com)

## Safety References



The safety alert symbol  is used to identify safety information about hazards that can result in personal injury. A signal word (DANGER, WARNING, or CAUTION) is used with the alert symbol to indicate the likelihood and the potential severity of injury. In addition, a hazard symbol may be used to represent the type of hazard.

 **DANGER** indicates a hazard which, if not avoided, **will result in death or serious injury**.

 **WARNING** indicates a hazard which, if not avoided, **could result in death or serious injury**.

 **CAUTION** indicates a hazard which, if not avoided, **might result in minor or moderate injury**.

















**CAUTION**, when used **without** the alert symbol, indicates a situation that **could result in damage to the engine**.

  This manual contains safety information to make you aware of the hazards and risks associated with engines, and how to avoid them. Because Briggs & Stratton does not necessarily know what equipment this engine will power, it is important that you read and understand these instructions and the instructions for the equipment this engine powers.

### Table of Contents

Safety References .....	2
Engine Features .....	3
Operator Safety .....	4 - 5
Quick Start Instructions .....	6 - 7
Troubleshooting .....	8
Readystart™ Engines .....	9
Starting and Stopping Instructions .....	10
Oil .....	11 - 12
Fuel .....	13
FRESH START™ Fuel Preserver Fuel Cap ...	14
Maintenance .....	15 - 17
Storage and Service .....	18
Engine Specifications .....	19
Emission Statement and Warranty .....	20 - 21
Engine Warranty Policy .....	22 - 23

## SYMBOLS ASSOCIATED WITH THIS ENGINE:

	Fire		Read Manual
	Explosion		Oil
	Kickback		Fuel
	Hot Surface		Fuel Shutoff
	Toxic Fumes		On Off
	Moving Parts		Choke
	Shock		Stop
	Hazardous Chemicals		Slow
			Fast

### WARNING

Briggs & Stratton does not approve or authorize the use of these engines on 3-wheel All Terrain Vehicles (ATVs), motor bikes, fun/recreational go-karts, aircraft products or vehicles intended for use in competitive events. Use of these engines in such applications could result in property damage, serious injury (including paralysis), or even death.

### WARNING

The engine exhaust from this product contains chemicals known to the State of California to cause cancer, birth defects, or other reproductive harm.

### CAUTION

This engine is shipped from Briggs & Stratton without oil. If you start the engine without oil, the engine will be damaged beyond repair and will not be covered under warranty.

## Engine Features

1. Rewind rope handle
2. Fuel cap
3. Air cleaner
4. Primer bulb
5. Spark plug wire
6. Engine identification  
Model Type and Date Code
7. Oil fill and dipstick
8. Side oil drain, if equipped
9. Muffler and spark arrester, if equipped

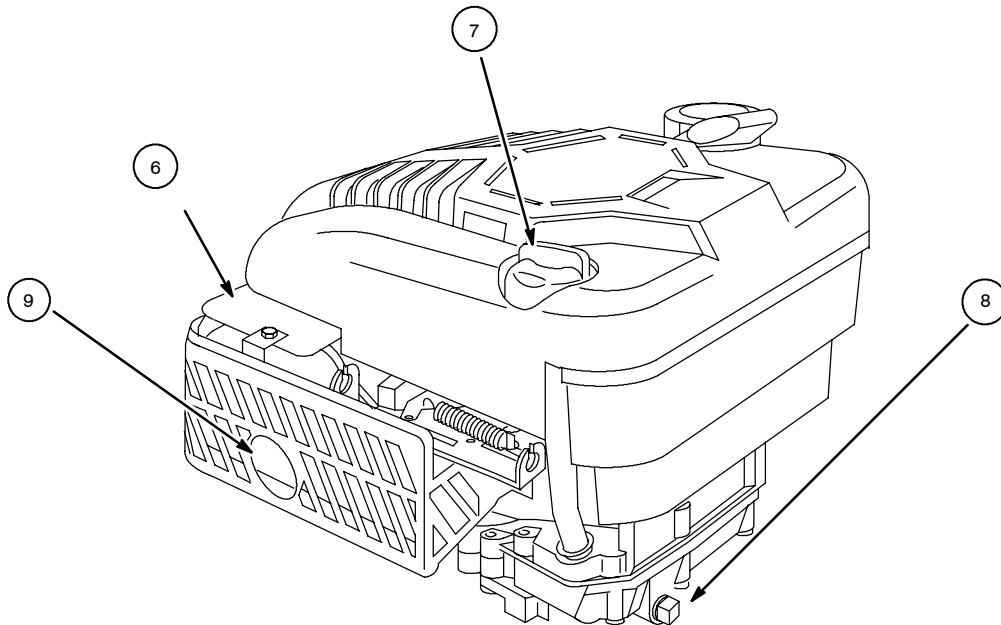
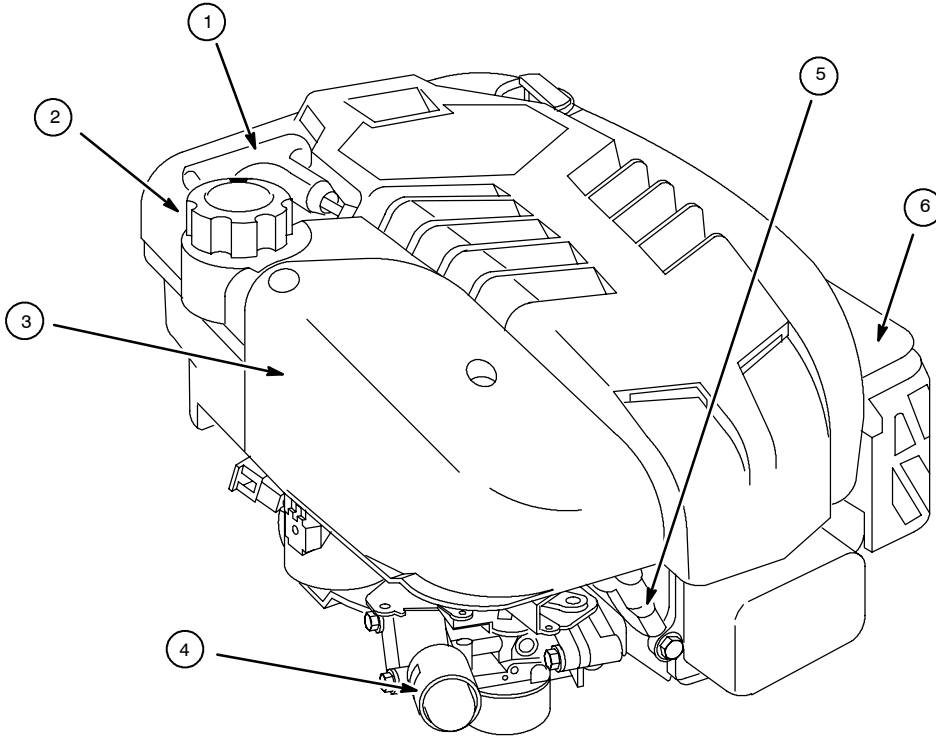

## Operator Safety



### WARNING

Gasoline and its vapors are extremely flammable and explosive. Fire or explosion can cause severe burns or death.

#### WHEN ADDING FUEL

- Turn engine OFF and let engine cool at least 2 minutes before removing gas cap.
- Fill fuel tank outdoors or in well-ventilated area.
- Do not overfill fuel tank.
- Keep gasoline away from sparks, open flames, pilot lights, heat, and other ignition sources.
- Check fuel lines, tank, cap, and fittings frequently for cracks or leaks. Replace if necessary.

#### WHEN STARTING ENGINE

- Make sure spark plug, muffler, fuel cap and air cleaner are in place.
- Do not crank engine with spark plug removed.
- If fuel spills, wait until it evaporates before starting engine.
- If engine floods, set choke to OPEN/RUN position, place throttle in FAST and crank until engine starts.

#### WHEN OPERATING EQUIPMENT

- Do not choke carburetor to stop engine.

#### WHEN TRANSPORTING EQUIPMENT

- Transport with fuel tank EMPTY.

#### WHEN STORING GASOLINE OR EQUIPMENT WITH FUEL IN TANK

- Store away from furnaces, stoves, water heaters or other appliances that have pilot light or other ignition source because they can ignite gasoline vapors.



### WARNING

Starting engine creates sparking. Sparking can ignite nearby flammable gases. Explosion and fire could result.

- If there is natural or LP gas leakage in area, do not start engine.
- Do not use pressurized starting fluids because vapors are flammable.

## Fresh Start™ Fuel Cap



### DANGER

Contents are HARMFUL OR FATAL IF SWALLOWED. Avoid contact to eyes, skin, or clothing. Do not take internally. Avoid breathing the mist or vapor. Overexposure to eyes or skin can cause irritation. KEEP STABILIZER OUT OF THE REACH OF CHILDREN. Fuel stabilizer is a hazardous chemical.\*\*



- IF SWALLOWED, call physician immediately. Do not induce vomiting. If inhaled, remove to fresh air. In case of eye or skin contact, flush with water for 15 minutes.
- Store unopened cartridges in a cool, dry, well-ventilated area. Keep open cartridge in fuel cap, and fuel cap closed on fuel tank when not in use.
- In case of emergency, contact a physician immediately.
- For material safety information call **1-800-424-9300**

\*\* Fuel stabilizer contains: 2,6-di-tert-butylphenol (128-39-2) and aliphatic petroleum distillate (64742-47-8).

## Your engine may be equipped with a Fresh Start™ Fuel Cap

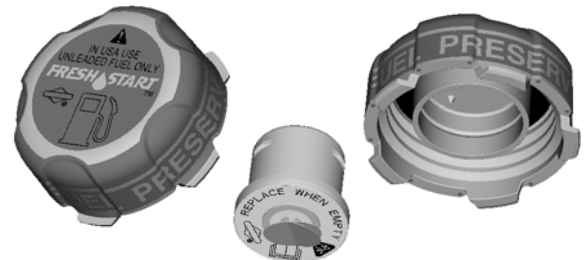

Cartridge is shown with tab partially removed.



### WARNING

Rapid retraction of starter cord (kickback) will pull hand and arm toward engine faster than you can let go. Broken bones, fractures, bruises or sprains could result.

- When starting engine, pull cord slowly until resistance is felt, then pull rapidly.
- Remove all external equipment/engine loads before starting engine.
- Direct coupled equipment components such as, but not limited to, blades, impellers, pulleys, sprockets, etc., must be securely attached.



### WARNING

Rotating parts can contact or entangle hands, feet, hair, clothing, or accessories. Traumatic amputation or severe laceration can result.

- Operate equipment with guards in place.
- Keep hands and feet away from rotating parts.
- Tie up long hair and remove jewelry.
- Do not wear loose-fitting clothing, dangling drawstrings or items that could become caught.



### WARNING

Engines give off carbon monoxide, an odorless, colorless, poison gas. Breathing carbon monoxide can cause nausea, fainting or death.

- Start and run engine outdoors.
- Do not start or run engine in enclosed area, even if doors or windows are open.



### WARNING



Running engines produce heat. Engine parts, especially muffler, become extremely hot. Severe thermal burns can occur on contact.



Combustible debris, such as leaves, grass, brush, etc. can catch fire.

- Allow muffler, engine cylinder and fins to cool before touching.
- Remove accumulated debris from muffler area and cylinder area.
- Install and maintain in working order a spark arrester before using equipment on forest-covered, grass-covered, brush-covered unimproved land. The state of California requires this (Section 4442 of the California Public Resources Code). Other states may have similar laws. Federal laws apply on federal land.



### WARNING

Unintentional sparking can result in fire or electric shock.



Fire or explosion can cause severe burns or death.



Unintentional start-up can result in entanglement, traumatic amputation, or laceration.

#### Before performing maintenance or repairs:

- Disconnect spark plug wire and keep it away from spark plug.
- Disconnect battery at negative terminal (only engines with electric start).
- Use only correct tools.
- Do not strike the flywheel with a hammer or hard object because the flywheel may later shatter during operation.
- Do not tamper with governor spring, links or other parts to increase engine speed.

#### When testing for spark:

- Use approved spark plug tester.
- Do not check for spark with spark plug removed.



This manual contains safety information to make you aware of the hazards and risks associated with engines. Read the Operating Manual before starting your engine.

## SIMPLE STEPS TO STARTING YOUR ENGINE ...



### ADD OIL

**WHAT KIND?**

High quality SAE 30 motor oil.

**HOW MUCH?**

To FULL line on dipstick.  
Engine holds about 20 oz. (0.61l).

**HOW?**

Unscrew and remove oil cap.  
Pour in oil. Replace cap.

**SPECIAL CONCERNS?**

Do not overfill.  
Do not tip engine.



See page 11 for details.

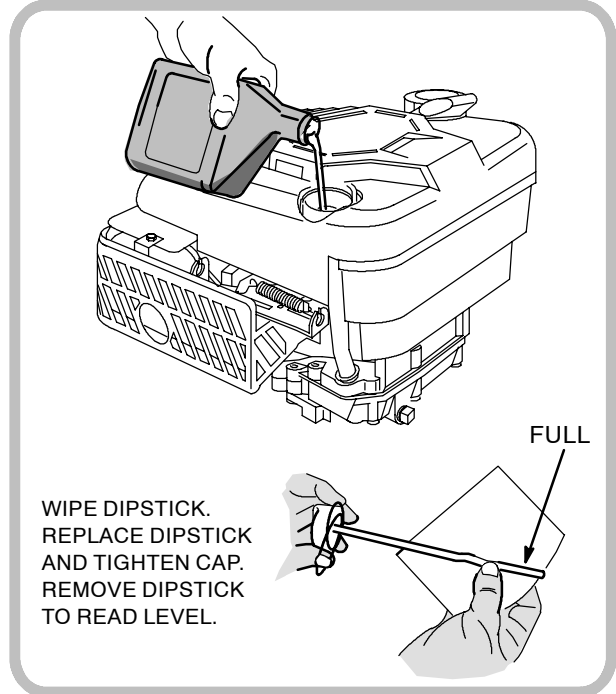

WIPE DIPSTICK.  
REPLACE DIPSTICK  
AND TIGHTEN CAP.  
REMOVE DIPSTICK  
TO READ LEVEL.

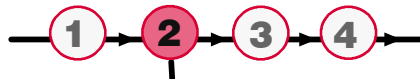

### ADD GAS

**WHAT KIND?**

Unleaded, 85 octane or higher.

**HOW MUCH?**

Fill to one inch below top of fuel fill neck.

**HOW?**

Remove gas cap. Pour in gas. Replace cap.

**SPECIAL CONCERNS?**

Fuel equipment outdoors. If fuel spills, wait until it evaporates before starting engine.



See page 13 for details.

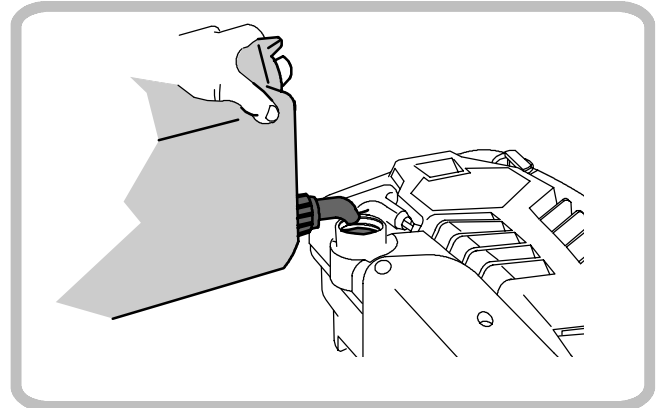

 **WARNING**



Starting engine creates sparking. Gasoline and its vapors are extremely flammable and explosive. Fire or explosion can cause severe burns or death.

If fuel spills, wait until it evaporates before starting engine.

DO NOT use pressurized starting fluids.



If **ReadyStart™** go to step 4.

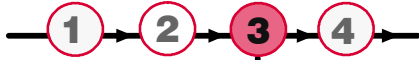

## **PUSH PRIMER**

### **HOW MANY TIMES?**

Press **5** times the **FIRST TIME** you start engine.  
For all future starts, press **3** times.

### **HOW?**

Locate primer bulb. Press with finger. Wait two seconds between each press.

### **SPECIAL CONCERNS?**

Pressing primer too many times can flood engine with gas. A flooded engine will not start. See *Troubleshooting* section.

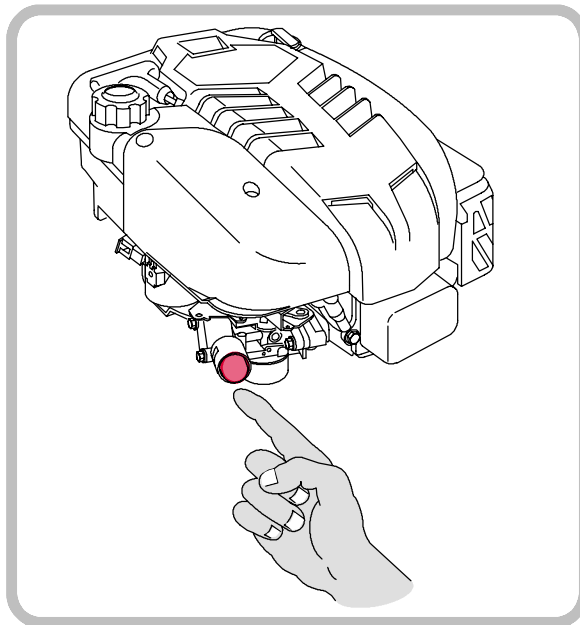

## **PULL STARTER HANDLE**

### **HOW?**

Stand behind equipment.  
Close bail, or operator control bar, on equipment with this feature. If you do not keep bail held against equipment handle, engine will not start.  
Slowly pull cord until you feel resistance, then pull quickly.

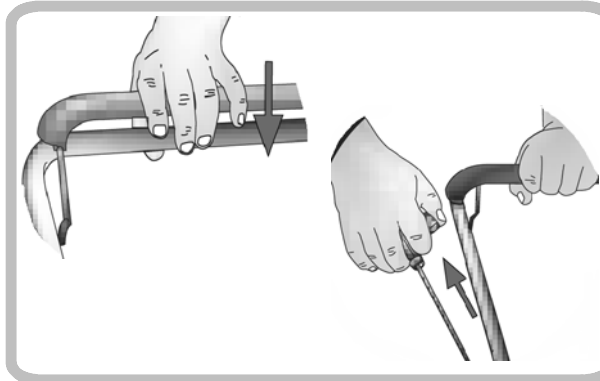

### **SPECIAL CONCERNS?**

If speed control equipped, start in **FAST** position. Also, see warning at right.



If **electric start** equipped see page 10.

## **To Stop Engine -**

Let go of bail, or operator control bar, which activates brake and stops engine from running.



For complete starting instructions see page 10.



### **WARNING**



Rapid retraction of starter cord (kickback) will pull hand and arm toward engine faster than you can let go.

Broken bones, fractures, bruises or sprains could result.



Rotating parts can cause traumatic amputation or severe laceration can result.

To avoid kickback, slowly pull the cord until you feel resistance, then pull rapidly.

Keep hands, feet, hair, clothing, or accessories away from rotating parts.



**Need assistance? 1-800-233-3723**



(USA and Canada ONLY, Pre-recorded message.)

[www.briggsandstratton.com](http://www.briggsandstratton.com)

# Troubleshooting

## Starter Handle will Not Pull

- Close bail or operator control bar.
- Place equipment on flat level surface.
- Remove all external equipment/engine loads before starting engine.
- Direct coupled equipment components such as, but not limited to, blades, impellers, pulleys, sprockets, etc., must be securely attached.

	 <b>WARNING</b>
	<p>Rapid retraction of starter cord (kickback) will pull hand and arm toward engine faster than you can let go. Broken bones, fractures, bruises or sprains could result.</p> <p>When starting engine, pull cord slowly until resistance is felt, then pull rapidly.</p>

## Engine will Not Start

### Out of Fuel

- Add fuel to tank.



### Engine Flooded

- Set choke (if equipped) to OPEN/RUN position, and continue to pull starter handle.

### Spark Plug Fouling

- Check and ensure the spark plug is clean. Check the gap with a feeler gage and reset to .51 mm or .020 in. if necessary.
- If the electrode is burned or worn, replace spark plug with new spark plug.

<b>CAUTION</b>
<p>This engine is shipped from Briggs &amp; Stratton without oil. If you start the engine without oil, the engine will be damaged beyond repair and will not be covered under warranty.</p>

 	 <b>WARNING</b>
	<p>Gasoline and its vapors are extremely flammable and explosive. Fire or explosion can cause severe burns or death.</p> <p>Ensure fuel cap is in place before starting engine Turn engine OFF and let engine cool at least 2 minutes before removing fuel cap. Check fuel lines, tank, cap, and fittings frequently for cracks or leaks. Replace if necessary. Do not crank engine with spark plug removed.</p>

## Engine is Smoking or Running Rough

### Engine may have been tipped during transport.

- Check for fouled spark plug.
- Check air cleaner filter for oil saturation. Squeeze pre-cleaner in clean, absorbant cloth to remove ALL EXCESS oil. If air cleaner is saturated, replace with new cartridge.

<b>CAUTION</b>
<p>To prevent oil or fuel from entering combustion chamber or air cleaner, keep the spark plug side of engine up during transport, when draining oil, cleaning debris, etc. otherwise engine damage could occur.</p>



## Readystart™ Instructions

1. Check the oil level. Ensure level is at FULL mark on the dipstick. Use a high quality motor oil. Check the oil recommendations for the correct oil type to use depending on expected starting temperatures.

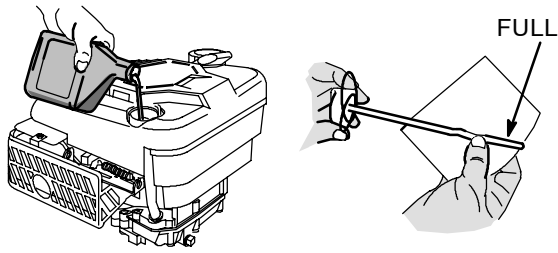

2. Move speed control to FAST, if equipped. Operate engine in FAST position.
3. Close bail, or operator control bar on equipment with this feature.

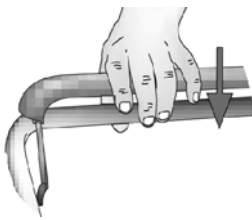

4. Start your engine. See options at right.

## Rewind Start

- Grasp rope handle. Pull slowly until resistance is felt, then pull rapidly to start engine and avoid kickback.

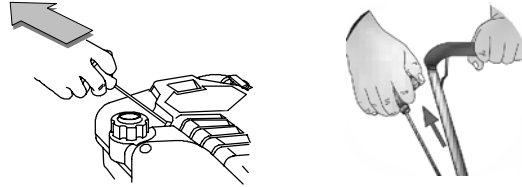

## Electric Start

- Insert key and turn to start.
- Allow engine to warm up.

### CAUTION

To prolong starter life use short starting cycles (5 seconds maximum, then wait one minute). Follow equipment manufacturer's recommendations for charging battery.

## Stopping Engine

- Release bail or operator control bar **-OR-** Move throttle (if equipped) to SLOW and then STOP position.

## Starting Instructions

1. Check oil level. Ensure level is at FULL mark on dipstick. Use a high quality motor oil. Check the oil recommendations for the correct oil type to use depending on expected starting temperatures.

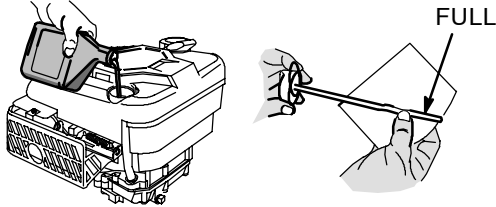

2. Open fuel shut-off valve 1/4 turn, if equipped.
3. Locate primer bulb on the engine and push 3 times **-OR-** rotate choke knob or move choke control lever to CHOKE position.

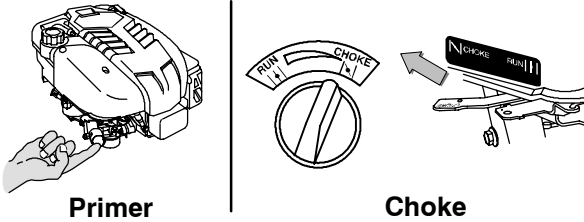

4. Move speed control to FAST, if equipped. Operate engine in FAST position.
5. Close bail, operator control bar on equipment with this feature.
6. Start your engine. See options stated here:

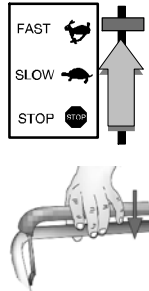

## Rewind Start

- Grasp rope handle. Pull slowly until resistance is felt, then pull rapidly to start engine and avoid kickback.



## Electric Start

- Insert key and turn to START.



### CAUTION

To prolong starter life, use short starting cycles (5 seconds maximum, then wait one minute). Follow equipment manufacturer's recommendations for charging battery.

7. Allow engine to warm up.

**Note: If choke equipped:** Slowly adjust toward RUN position. Wait until engine runs smoothly before each choke adjustment.

## Stopping Engine



### WARNING

Do not stop engine by moving choke control to CHOKE. Backfire, fire or engine damage could occur.

1. Move throttle lever (if equipped) to SLOW, then release safety brake control handle **-OR-** Move throttle (if equipped) to SLOW and then STOP position.
2. Push stop switch (if equipped) to OFF **-OR-** Turn key to OFF. Remove key and store out of reach of children.
3. Close fuel shut-off valve (if equipped).

# Oil

Check oil level before starting the engine.  
Keep oil level at FULL. Do not overfill.  
Check level daily, or after every eight (8) hours.

## Capacity

Engine oil capacity is 2/3 qt. (22 oz.; 0.65 liter). **NOTE:** Often residual oil remains in engine. Fill to FULL line on dipstick.

## Oil Recommendation

Use a high quality detergent oil classified "For Service SF, SG, SH, SJ" or higher.  
Do not use special additives.

**SAE 30** 40°F and higher (5°C and higher)  
is good for all purpose use above 40°F, use below 40°F will cause hard starting.

**10W-30** 0 to 100°F (-18 to 38°C)  
is better for varying temperature conditions. This grade of oil improves cold weather starting, but may increase oil consumption at 80°F (27°C) or higher.

**\*** Check oil level frequently at higher temperatures.

**Synthetic 5W-30** -20 to 120°F (-30 to 40°C)  
provides the best protection at all temperatures as well as improved starting with less oil consumption.

**5W-30** 40°F and below (5°C and below)  
is recommended for winter use, and works best in cold conditions.

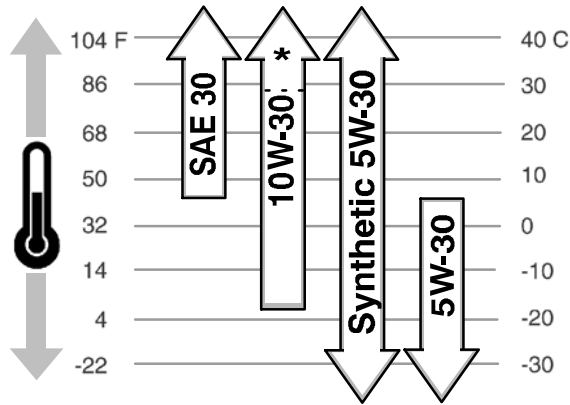

## Checking and Adding Oil

1. Place engine level and clean around oil fill area.
5. If needed, add oil slowly.

### Oil Fill

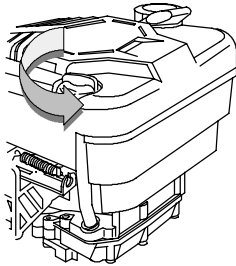

2. Remove dipstick and wipe with clean cloth.
3. Replace and tighten dipstick. Remove and check oil level.
4. Oil level should be at FULL line on dipstick.

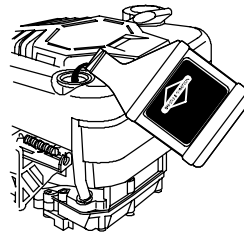
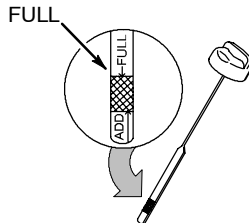

6. Re-check oil level. **Do not over fill.**
7. Replace and tighten dipstick.

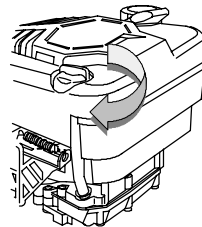

## Changing Oil

Change oil after first 5 to 8 hours of use, then every 50 hours. Change oil every 25 hours when operating the engine under heavy load or in high temperatures.

1. Run engine until it runs out of fuel. Otherwise, fuel can leak out, creating a fire/explosion hazard, when you tip engine in Step 4.
2. Disconnect spark plug wire and keep it away from spark plug.
3. With engine OFF but still warm remove dipstick.
4. Drain oil into appropriate receptacle.  
**Top oil drain:** Keep air cleaner above oil outlet.  
**Bottom or side oil drain (if equipped):** Keep engine level.

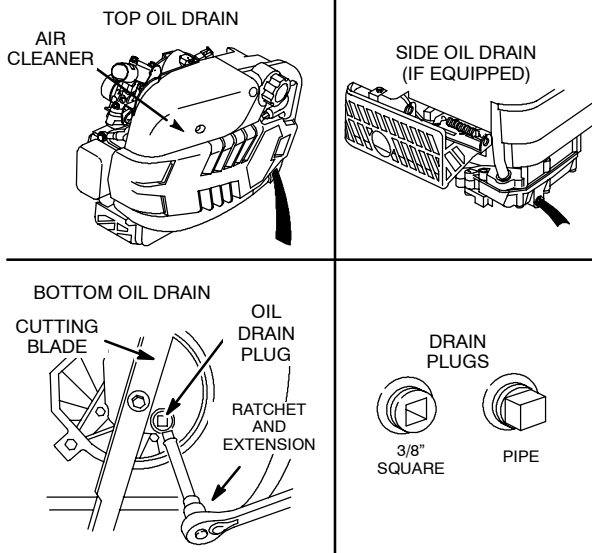

Top oil drain is recommended method, however oil can drain from side (if equipped) or bottom as shown.

5. Place engine level. Add about 20 oz or 0.61 liter of oil. Note: Often residual oil remains in engine. Fill to FULL line on dipstick. **Do not overfill.**

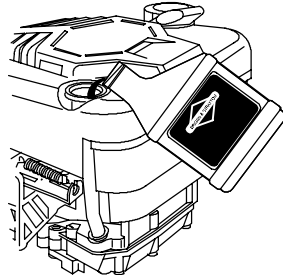

6. Replace dipstick.

### CAUTION

Used oil is a hazardous waste product. Dispose of used oil properly. Do not discard with household waste. Check with your local authorities, service center, or dealer for safe disposal/recycling facilities.

### WARNING



To prevent unintentional starting, disconnect spark plug wire and keep it away from spark plug.

Unintentional start-up can result in shock, entanglement, traumatic amputation, or laceration.

## Changing Oil Filter (if equipped)

Replace oil filter after every 100 hours of operation.

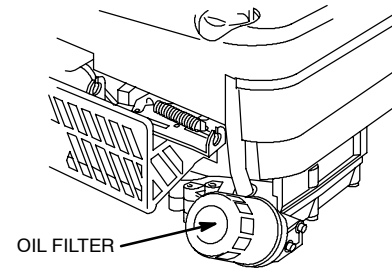

1. After draining engine of used oil, fill with fresh oil.
2. Before installing new filter, lightly oil gasket with fresh, clean oil.
3. Screw filter on by hand until gasket contacts oil filter adapter.
4. Tighten 1/2 - 3/4 turn more.
5. Start and run engine at idle to check for leaks.
6. Stop engine. Re-check oil level. Add oil if required.

# Fuel

## Type of gasoline to use

This engine is certified to operate on gasoline. The emission control system for this engine is EM (Engine Modifications).

**Always** use gasoline that meets these requirements:

- Clean, fresh unleaded gasoline.
- A minimum of 87 octane/87 AKI (91 RON). If operating at high altitude, see below.
- Gasoline with up to 10% ethanol (gasohol) or up to 15% MTBE (methyl tertiary butyl ether), is acceptable.
- Use of any gasoline other than those approved above will void the engine warranty. In some local areas fuel pumps may be marked if the gasoline contains alcohols or ethers. If you are unsure about the gasoline you purchase check with your fuel provider.
- Do not modify the engine fuel system or carburetor to run on alternative fuels.
- Never mix oil with gasoline.

All gasoline is not the same. If you experience starting or performance problems after new gasoline has been used in your engine, switch to a different fuel provider or change fuel brands.

### CAUTION

Some fuels, called oxygenated or reformulated fuels, are fuels blended with alcohols or ethers. Excessive amounts of these blends can damage the fuel system or cause performance problems. If any undesirable operating symptoms occur, use gasoline with a lower percentage of alcohol or ether.

## Fuel Storage

Fuel can become stale when stored over 30 days. Stale fuel causes acid and gum deposits to form in fuel system or on essential carburetor parts. Mix fuel stabilizer with fuel in tank or storage container. Run engine for a short time to circulate stabilizer through carburetor and engine. Engine and fuel can be stored up to 24 months.

If fuel stabilizer is not used, you need to drain gasoline from equipment prior to storage.

If the FRESH START continuous fuel preserver fuel cap (concentrated liquid cartridge) is used, there is no need to drain fuel, as long as cartridge contains stabilizer for seasonal storage.

## Fuel Stabilizer

To protect the fuel system from gum formation, use Briggs & Stratton FRESH START™ fuel stabilizer plus, or FRESH START continuous fuel preserver fuel cap (concentrated liquid cartridge), or FRESH START preservative & stabilizer (granular).

## High-altitude Use

At higher altitudes (over 5,000 feet), 85 octane/85 AKI (89 RON) gasoline can be used. Operation at high altitude may require a high-altitude carburetor jet kit to improve performance and decrease fuel consumption. See your local authorized Briggs & Stratton dealer for more information.

## Adding Fuel

1. Turn engine OFF and let engine cool at least 2 minutes before removing gas cap.
2. Remove cap. Fill tank to approximately 1 inch (25mm) below top of neck to allow for fuel expansion. Be careful not to overfill.
3. Replace cap before starting.

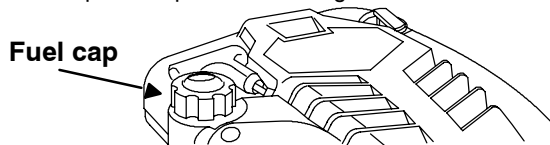

### WARNING



Gasoline and its vapors are extremely flammable and explosive.



Fire or explosion can cause severe burns or death.

### WHEN ADDING FUEL

- Turn engine OFF and let engine cool at least 2 minutes before removing gas cap.
- Fill fuel tank outdoors or in well-ventilated area.
- Do not overfill fuel tank.
- Keep gasoline away from sparks, open flames, pilot lights, heat, and other ignition sources.
- Check fuel lines, tank, cap, and fittings frequently for cracks or leaks. Replace if necessary.

## Fresh Start™ Continuous Fuel Preserver - Fuel Cap

Your engine may be equipped with a Fresh Start fuel cap.

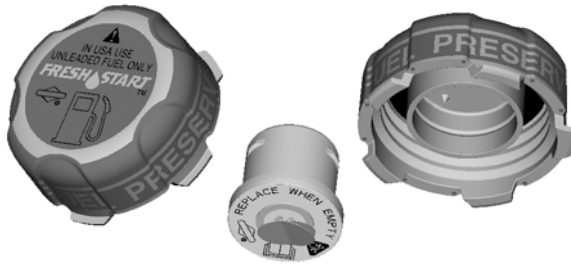

Cartridge is shown with tab partially removed.

Fresh Start fuel cap is designed to hold a cartridge which contains fuel stabilizer.

1. Place silver foil seal end of cartridge into fuel cap.
2. Press to “snap” cartridge into place.
3. Remove the white tab to expose membrane.
4. Reinstall fuel cap on engine fuel tank.
5. Check periodically - if empty, remove and replace.



### DANGER



Contents are HARMFUL OR FATAL IF SWALLOWED. Avoid contact to eyes, skin, or clothing. Do not take internally. Avoid breathing the mist or vapor. Overexposure to eyes or skin can cause irritation. KEEP STABILIZER OUT OF THE REACH OF CHILDREN. Fuel stabilizer is a hazardous chemical.\*\*



- IF SWALLOWED, call physician immediately. Do not induce vomiting. If inhaled, remove to fresh air. In case of eye or skin contact, flush with water for 15 minutes.
- Store unopened cartridges in a cool, dry, well-ventilated area. Keep open cartridge in fuel cap, and fuel cap closed on fuel tank when not in use.
- *In case of emergency, contact a physician immediately and call 1-800-424-9300 for material safety information.*

\*\* Fuel stabilizer contains: 2,6-di-tert-butylphenol (128-39-2) and aliphatic petroleum distillate (64742-47-8).

# Engine Maintenance

Regular maintenance will improve the performance and extend the life of the engine. See any Authorized Briggs & Stratton Dealer for service. **Use only genuine Briggs & Stratton parts. Other parts may not perform as well, may damage the engine, and may result in injury.** In addition, use of other parts may void your warranty.

## Emission Control

**Maintenance, replacement or repair of the emission control devices and systems may be performed by any nonroad engine repair establishment or individual.** However, to obtain no charge repairs under the terms and provisions of the Briggs & Stratton warranty statement, any service or emission control part repair or replacement must be performed by a factory authorized dealer. See Emission Warranty..

## Follow the instructions and schedules indicated below:

**WARNING**

Unintentional sparking can result in fire or electric shock.  
Fire or explosion can cause severe burns or death.

Unintentional start-up can result in entanglement, traumatic amputation, or laceration.

- Do not strike the flywheel with a hammer or hard object because the flywheel may later shatter during operation.
- Do not tamper with governor spring, links or other parts to increase engine speed.

**Before performing maintenance or repairs:**

- Disconnect spark plug wire and keep it away from spark plug.
- Disconnect battery at negative terminal (only engines with electric start).
- Use only correct tools.

**When testing for spark:**

- Use approved spark plug tester.
- Do not check for spark with spark plug removed.

Task <i>Perform task at hourly or calendar interval, whichever comes first.</i>	Every 8 Hours or Daily	25 Hours	50 Hours	100 Hours	100-400 Hours
Check Oil Level					
Clean Debris*					
Service Air Cleaner*					
Change Oil **					
Inspect Spark Arrester (if equipped)					
Change Oil Filter (if equipped)**					
Replace Spark Plug					
Replace In-line Fuel Filter (if equipped)					
Clean Air Cooling System***					
Check Valve Clearance					

\* Clean more often under dusty conditions or when airborne debris is present. Replace air cleaner, if very dirty.

\*\* **Change oil after first 5 to 8 hours of use**, then every 50 hours. Change oil every 25 hours when operating the engine under heavy load or in high temperatures.

\*\*\* On string trimmer applications clean debris at each refueling, sooner if needed and have qualified technician clean air cooling system every 30 hours, every season, or sooner if needed especially in high debris conditions.

## Air Cleaner

All engines have an air cleaner cartridge. The cartridge is either flat or oval. In addition, some engines have a pre-cleaner.

### CAUTION

Do not use pressurized air or solvents to clean cartridge. Pressurized air can damage cartridge; solvents will dissolve cartridge.

### Removing and Installing Flat Air Cleaner

ASSEMBLE SO CARTRIDGE LIP TOUCHES  
BASE IN DIRECTION SHOWN

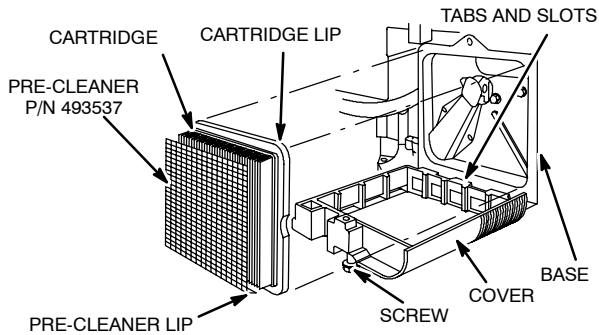

#### Flat Air Cleaner

1. Loosen screw, tilt cover down and remove air cleaner.
2. Install clean (or new) air cleaner assembly inside cover. Lip of pre-cleaner (if equipped) must be at bottom of cartridge pleats.
3. Insert cover tabs into slots in bottom of base.
4. Tilt cover up into place and tighten screw.

### Removing and Installing Oval Air Cleaner

ASSEMBLE SO THAT CARTRIDGE  
LIP SITS INSIDE BASE

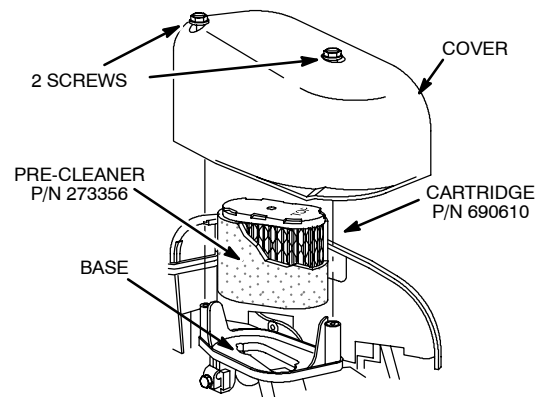

#### Oval Air Cleaner

5. Loosen two screws and lift off cover.
6. Remove air cleaner assembly (pre-cleaner, if equipped, and cartridge) from base.
7. Install clean (or new) air cleaner assembly in base. Air cleaner must fit securely in base.
8. Place cover over air cleaner.
9. Tighten screws.



### WARNING

Ensure air cleaner, retainer, and cover are properly installed before starting engine.

## Spark Plug

Check the spark plug every 100 hours. Replace the spark plug if upon inspection the electrode is burned or worn. Ensure the spark plug is clean. Check the gap with a feeler gage and reset to .020 (0.51 mm) if necessary. Use only Briggs & Stratton Spark Tester (part number 19368) to check for spark.

**Note:** In some areas, local law requires using a resistor spark plug to suppress ignition signals. If this engine was originally equipped with a resistor spark plug, use same type for replacement.

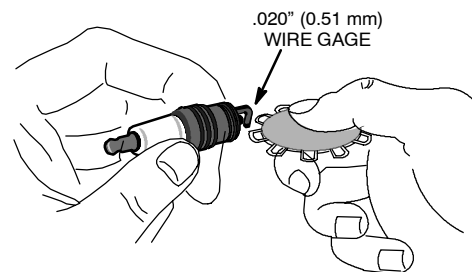



## Cleaning Debris

Daily or before every use, clean accumulated debris from engine. Keep linkage, spring and controls clean. Keep area behind muffler free of any combustible debris.

On string trimmer applications, clean accumulated debris at each refueling, sooner if needed.

### CAUTION

Do not use water to clean engine parts. Water could contaminate fuel system. Use a brush or dry cloth.

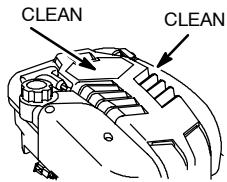

Finger Guard

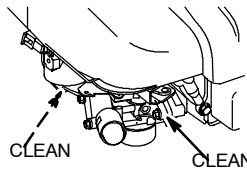

Linkage, Springs, Controls

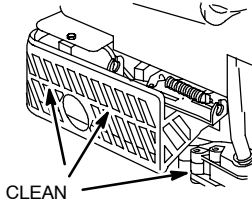

Muffler

## Fuel System

### Replacing In-line Fuel Filter (if equipped)

Disconnect spark plug wire and keep away from spark plug.

Drain Fuel tank or close fuel shut-off valve before replacing fuel filter. Otherwise, fuel can leak out creating a fire/explosion hazard.

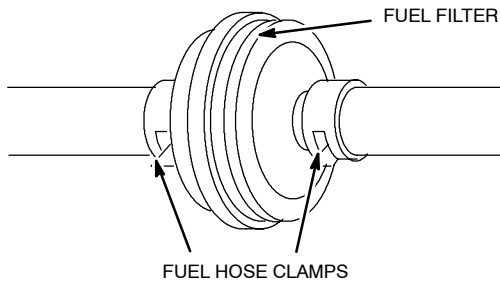

### WARNING

Replacement parts for fuel system (cap, hoses, tanks, filters, etc.) must be the original parts, otherwise fire can occur.

## Muffler

If muffler is equipped with spark arrester screen, remove screen for inspection. Replace screen if damaged or plugged.



### WARNING

Replacement parts for muffler must be the same and installed in the same position as the original parts, otherwise fire can occur.

## Air Cooling System

Over time debris may accumulate in cylinder cooling fins and cannot be observed without partial engine disassembly. For this reason, we recommend that you have an authorized Briggs & Stratton Service Dealer clean the air cooling system per recommended intervals (See Maintenance Schedule). Equally important is to keep top of engine free from debris. See cleaning debris below.



### WARNING

Engine parts should be kept clean to reduce the risk of overheating and ignition of accumulated debris.

## Storage

Equipment stored with fuel can become stale when stored over 30 days. Stale fuel causes acid and gum deposits to form in fuel system or on essential carburetor parts. Mix fuel stabilizer with fuel in tank or storage container. Run engine for a short time to circulate stabilizer through carburetor and engine. Engine and fuel can be stored up to 24 months.

### If fuel stabilizer is not used, you need to drain gasoline from equipment prior to storage.

If the FRESH START continuous fuel preserver fuel cap (concentrated liquid cartridge) is used, there is no need to drain fuel, as long as cartridge contains stabilizer for seasonal storage.

Perform the following before long-term storage of equipment.

1. While engine is still warm, change oil.
2. Remove spark plug and pour about 1/2 oz (15ml) of engine oil into spark plug cavity which puts oil into cylinder. Replace spark plug securely.
3. Pull starter rope slowly. This turns the engine's crankshaft and distributes oil through the engine.
4. Add fuel stabilizer or drain fuel from engine.
5. Clean dirt and chaff from engine, cylinder head fins, blower housing and rotating screen areas.
6. Store in a clean, dry area.



### WARNING

Do not store engine in same area as a stove, furnace, water heater or other appliance that uses a pilot light or has a device that can create a spark.

## Service

See an Authorized Briggs & Stratton Service Dealer for all your engine service needs. Each one carries a stock of Genuine Briggs & Stratton Parts and is equipped with special service tools. Trained mechanics assure expert repair service on all Briggs & Stratton engines. Only dealers advertising as "Authorized Briggs & Stratton" are required to meet Briggs & Stratton standards.

When you purchase equipment powered by Briggs & Stratton, you are assured of highly skilled, reliable engine service at more than 30,000 Authorized Service Dealers worldwide, including more than 6,000 Master Service Technicians. Look for these signs wherever Briggs & Stratton service is offered.



You may find the nearest Authorized Service Dealer in our dealer locator map at [www.briggsandstratton.com](http://www.briggsandstratton.com) or by calling 1-800-233-3723.

## PARTIAL LIST OF GENUINE BRIGGS & STRATTON PARTS

<u>PART</u>	<u>PART NO.</u>
Flat Air Cleaner Cartridge . . . . .	491588 -OR- 5043
Flat Air Cleaner Pre-cleaner . . . . .	493537
Oval Air Cleaner Cartridge . . . . .	697029
Oval Air Cleaner Pre-cleaner . . . . .	273356
Oil . . . . .	100005 -OR- 100028
Synthetic Oil . . . . .	100074
Fuel Filter . . . . .	298090 -OR- 5018
Gas Additive . . . . .	5041
Resistor Spark Plug . . . . .	491055
Spark Plug Wrench . . . . .	89838
Spark Tester . . . . .	19368
Oil Pump Kit . . . . .	5056
(uses standard electric drill to remove oil from engine quickly.)	

An illustrated shop manual includes common specifications and detailed information covering adjustment, tune-up and repair of Briggs & Stratton single cylinder, 4 cycle engines. It is available for purchase from an Authorized Briggs & Stratton Service Dealer or you can order it from [www.briggsandstratton.com](http://www.briggsandstratton.com)

Briggs & Stratton Engines Are Made Under One Or More Of The Following Patents: Design D-247,177 (Other Patents Pending)

6,691,683	6,472,790	6,239,709	6,040,767	5,765,713	5,503,125	5,197,425	4,977,879	4,453,507
6,647,942	6,460,502	6,237,555	6,014,808	5,732,555	5,501,203	5,197,422	4,977,877	4,430,984
6,622,683	6,456,515	6,230,678	6,012,420	5,645,025	5,497,679	5,191,864	4,971,219	D 476,629
6,615,787	6,382,166	6,213,083	5,992,367	5,642,701	5,320,795	5,188,069	4,895,119	D 457,891
6,617,725	6,369,532	6,202,616	5,904,124	5,628,352	5,301,643	5,186,142	4,875,448	D 368,187
6,603,227	6,356,003	6,145,487	5,894,715	5,619,845	5,271,363	5,150,674	4,819,593	D 375,963
6,595,897	6,349,688	6,142,257	5,887,678	5,606,948	5,269,713	5,138,996	4,720,638	D 309,457
6,595,176	6,347,614	6,135,426	5,852,951	5,606,851	5,265,700	5,086,890	4,719,682	D 372,871
6,584,964	6,325,036	6,116,212	5,843,345	5,605,130	5,243,878	5,070,829	4,633,556	D 361,771
6,557,833	6,311,663	6,105,548	5,823,153	5,497,679	5,235,943	5,058,544	4,630,498	D 356,951
6,542,074	6,284,123	6,347,614	5,819,513	5,548,955	5,234,038	5,040,644	4,522,080	D 309,457
6,520,141	6,263,852	6,082,323	5,813,384	5,546,901	5,228,487	5,009,208	4,520,288	D 308,872
6,495,267	6,260,529	6,077,063	5,809,958	5,445,014	5,197,426	4,996,956	4,512,499	D 308,871
6,494,175	6,242,828	6,064,027	5,803,035					

# Engine Specifications

## CAUTION

All the components used to build this engine assembly must remain in place for the proper operation of this engine.

We recommend that you use an authorized Briggs & Stratton Service Dealer for all maintenance and service of the engine and engine parts. Use only genuine Briggs & Stratton parts.

### General Information

This is a single cylinder, overhead valve (OHV), air-cooled engine. It is a low emissions engine.

In the state of California, OHV Model Series 110000 and 120000 engines are certified by the California Air Resources Board to meet emissions standards for 125 hours. Such certification does not grant the purchaser, owner or operator of this engine any additional warranties with respect to the performance or operational life of this engine. This engine is warranted solely according to the product and emissions warranties stated elsewhere in this manual.

### Model, Type and Code Number

To get replacement parts or technical assistance in the future write your engine Model, Type and Code number along with the date of purchase here. These numbers are located on your engine. For the location, see page 3, **Engine Features**.

#### Model Series

--	--	--	--	--	--	--

#### Type

--	--	--	--	--	--	--

#### Code

--	--	--	--	--	--	--	--	--	--

### Model Series 110000

Bore . . . . . 2-11/16 in. (68.26 mm)  
 Stroke . . . . . 1-51/64 in. (46.00 mm)  
 Displacement . . . . . 10.20 cu. in. (167.4 cc)

### Model Series 120000

Bore . . . . . 2-11/16 in. (68.26 mm)  
 Stroke . . . . . 2-3/64 in. (52.00 mm)  
 Displacement . . . . . 11.58 cu. in. (189.7 cc)

### Tune up Specifications

Armature air gap . . 0.006 - 0.014 in. (0.15 - 0.36 mm)  
 Spark plug gap . . . . . 0.020 in. (0.51 mm)  
 Valve clearance with valve springs installed and piston 1/4 in. (6 mm) past top dead center (check when engine is cold). Consult with an Authorized Dealer or repair manual.  
 Intake . . . . . 0.004 - 0.006 in. (0.10 - 0.15 mm)  
 Exhaust . . . . . 0.004 - 0.008 in. (0.10 - 0.20 mm)

**Note:** For practical operation, the horsepower loading should not exceed 85% of rated horsepower. Engine power will decrease 3-1/2% for each 1,000 feet (300 meters) above sea level and 1% for each 10° F (5.6° C) above 77° F (25° C). It will operate satisfactorily at an angle up to 15°.

# Technical Information

**Power Ratings:** The power ratings for an individual engine model are initially developed by starting with SAE (Society of Automotive Engineers) code J1940 (Small Engine Power & Torque Rating Procedure) (Revision 2002-05). Given both the wide array of products on which our engines are placed, and the variety of environmental issues applicable to operating the equipment, it may be that the engine you have purchased will not develop the rated horsepower when used in a piece of power equipment (actual "on-site" power). This difference is due to a variety of factors including, but not limited to, the following: differences in altitude, temperature, barometric pressure, humidity,

fuel, engine lubrication, maximum governed engine speed, individual engine to engine variability, design of the particular piece of power equipment, the manner in which the engine is operated, engine run-in to reduce friction and clean out of combustion chambers, adjustments to the valves and carburetor, and other factors. The power ratings may also be adjusted based on comparisons to other similar engines utilized in similar applications, and will therefore not necessarily match the values derived using the foregoing codes.

## Emission Information

Engines that are certified to meet the California Air Resources Board (CARB) Tier 2 Emission Standards must display information regarding the Emissions Durability Period and the Air Index. Briggs & Stratton makes this information available to the consumer on our emission labels. The engine emission label will indicate certification information.

The **Emissions Durability Period** describes the number of hours of actual running time for which the engine is certified to be emissions compliant, assuming proper maintenance in accordance with the Operating & Maintenance Instructions. The following categories are used:

**Moderate:**

Engine is certified to be emission compliant for 125 hours of actual engine running time.

**Intermediate:**

Engine is certified to be emission compliant for 250 hours of actual engine running time.

**Extended:**

Engine is certified to be emission compliant for 500 hours of actual engine running time. For example, a typical walk-behind lawn mower is used 20 to 25 hours per year. Therefore, the **Emissions Durability Period** of an engine with an **intermediate** rating would equate to 10 to 12 years.

Certain Briggs & Stratton engines will be certified to meet the United States Environmental Protection Agency (USEPA) Phase 2 emission standards. For Phase 2 certified engines, the Emissions Compliance Period referred to on the Emissions Compliance label indicates the number of operating hours for which the engine has been shown to meet Federal emission requirements.

For engines less than 225 cc displacement.

Category C = 125 hours

Category B = 250 hours

Category A = 500 hours

For engines of 225 cc or more displacement.

Category C = 250 hours

Category B = 500 hours

Category A = 1000 hours.

# Emission Warranty Information

## **Briggs & Stratton Corporation (B&S), the California Air Resources Board (CARB) and the United States Environmental Protection Agency (U.S. EPA) Emissions Control System Warranty Statement (Owner's Defect Warranty Rights and Obligations)**

The California Air Resources Board (CARB), U.S. EPA and B&S are pleased to explain the Emissions Control System Warranty on your small off-road engine (SORE). In California, new small off-road engines model year 2006 and later must be designed, built and equipped to meet the State's stringent anti-smog standards.

Elsewhere in the United States, new non-road, spark-ignition engines certified for model year 1997 and later must meet similar standards set forth by the U.S. EPA. B&S must warrant the

emissions control system on your engine for the periods of time listed below, provided there has been no abuse, neglect or improper maintenance of your small off-road engine.

Your emissions control system includes parts such as the carburetor, air cleaner, ignition system, fuel line, muffler and catalytic converter. Also included may be connectors and other emissions related assemblies.

Where a warrantable condition exists, B&S will repair your small off-road engine at no cost to you including diagnosis, parts and labor.

### **Briggs & Stratton Emissions Control Defects Warranty Coverage**

Small off-road engines are warranted relative to emissions control parts defects for a period of two years, subject to provisions set forth below. If any covered part on your engine is defective, the part will be repaired or replaced by B&S.

### **Owner's Warranty Responsibilities**

As the small off-road engine owner, you are responsible for the performance of the required maintenance listed in your Operating and Maintenance Instructions. B&S recommends that you retain all your receipts covering maintenance on your small off-road engine, but B&S cannot deny warranty solely for the lack of receipts or for your failure to ensure the performance of all scheduled maintenance.

As the small off-road engine owner, you should however be aware that B&S may deny you warranty coverage if your small off-road engine or a part has failed due to abuse, neglect, improper maintenance or unapproved modifications.

You are responsible for presenting your small off-road engine to an Authorized B&S Service Dealer as soon as a problem exists.

The undisputed warranty repairs should be completed in a reasonable amount of time, not to exceed 30 days.

If you have any questions regarding your warranty rights and responsibilities, you should contact a B&S Service Representative at 1-414-259-5262.

The emissions warranty is a defects warranty. Defects are judged on normal engine performance. The warranty is not related to an in-use emissions test.

### **Briggs & Stratton Emissions Control Defects Warranty Provisions**

The following are specific provisions relative to your Emissions Control Defects Warranty Coverage. It is in addition to the B&S engine warranty for non-regulated engines found in the Operating and Maintenance Instructions.

#### **1. Warranted Parts**

Coverage under this warranty extends only to the parts listed below (the emissions control systems parts) to the extent these parts were present on the engine purchased.

##### **a. Fuel Metering System**

- Cold start enrichment system
- Carburetor and internal parts
- Fuel Pump
- Fuel line, fuel line fittings, clamps

##### **b. Air Induction System**

- Air cleaner
- Intake manifold

##### **c. Ignition System**

- Spark plug(s)
- Magneto ignition system

##### **d. Catalyst System**

- Catalytic converter
- Exhaust manifold
- Air injection system, Pulse valve

##### **e. Miscellaneous Items**

- Vacuum, temperature, position, time sensitive valves and switches
- Connectors and assemblies

#### **2. Length of Coverage**

B&S warrants to the initial owner and each subsequent purchaser that the Warranted Parts shall be free from defects in materials and workmanship which caused the failure of the Warranted Parts for a period of two years from the date the engine is delivered to a retail purchaser.

#### **3. No Charge**

Repair or replacement of any Warranted Part will be performed at no charge to the owner, including diagnostic labor which leads to the determination that a Warranted Part is defective, if the diagnostic work is performed at an Authorized B&S Service Dealer. For emissions warranty

service contact your nearest Authorized B&S Service Dealer as listed in the "Yellow Pages" under "Engines, Gasoline," "Gasoline Engines," "Lawn Mowers," or similar category.

#### **4. Claims and Coverage Exclusions**

Warranty claims shall be filed in accordance with the provisions of the B&S Engine Warranty Policy. Warranty coverage shall be excluded for failures of Warranted Parts which are not original B&S parts or because of abuse, neglect or improper maintenance as set forth in the B&S Engine Warranty Policy. B&S is not liable to cover failures of Warranted Parts caused by the use of add-on, non-original, or modified parts.

#### **5. Maintenance**

Any Warranted Part which is not scheduled for replacement as required maintenance or which is scheduled only for regular inspection to the effect of "repair or replace as necessary" shall be warranted as to defects for the warranty period. Any Warranted Part which is scheduled for replacement as required maintenance shall be warranted as to defects only for the period of time up to the first scheduled replacement for that part. Any replacement part that is equivalent in performance and durability may be used in the performance of any maintenance or repairs. The owner is responsible for the performance of all required maintenance, as defined in the B&S Operating and Maintenance Instructions.

#### **6. Consequential Coverage**

Coverage hereunder shall extend to the failure of any engine components caused by the failure of any Warranted Part still under warranty.

# Engine Warranty Policy

Effective January 1, 2006 replaces all undated Warranties and all Warranties dated before January 1, 2006.

## LIMITED WARRANTY

Briggs & Stratton Corporation will repair or replace, free of charge, any part(s) of the engine that is defective in material or workmanship or both. Transportation charges on product submitted for repair or replacement under this warranty must be borne by purchaser. This warranty is effective for the time periods and subject to the conditions stated below. For warranty service, find the nearest Authorized Service Dealer in our dealer locator map at [www.briggsandstratton.com](http://www.briggsandstratton.com), or by calling 1-800-233-3723.

THERE IS NO OTHER EXPRESS WARRANTY. IMPLIED WARRANTIES, INCLUDING THOSE OF MERCHANTABILITY AND FITNESS FOR A PARTICULAR PURPOSE, ARE LIMITED TO ONE YEAR FROM PURCHASE, OR TO THE EXTENT PERMITTED BY LAW ANY AND ALL IMPLIED WARRANTIES ARE EXCLUDED. LIABILITY FOR INCIDENTAL OR CONSEQUENTIAL DAMAGES ARE EXCLUDED TO THE EXTENT EXCLUSION IS PERMITTED BY LAW. Some states or countries do not allow limitations on how long an implied warranty lasts, and some states or countries do not allow the exclusion or limitation of incidental or consequential damages, so the above limitation and exclusion may not apply to you. This warranty gives you specific legal rights and you may also have other rights which vary from state to state and country to country.

## WARRANTY TERMS\*\*

Brand / Product Type	Consumer Use	Commercial Use	Condition of Warranty Term
Classic™	1 year	90 days	2 years Consumer Use in European Union
Etek™	1 year	1 year	
Etended Life Series™	2 years	1 year	
Fource™	2 years	90 days	
I/C™	2 years	1 year	
Industrial Plus™	2 years	1 year	
Intek™ (Kool Bore)	2 years	90 days	
Intek™ (Sleeve Bore)	2 years	1 year	
Kerosene fuel operated engines	1 year	90 days	
Powerbuilt™ OHV	2 years	90 days	
Q45™	2 years	90 days	
Quantum®	2 years	90 days	
Quattro™	2 years	90 days	
Sprint™	2 years	90 days	
Vanguard™	2 years	2 years	
2-Cycle Snow engine	2 years	90 days	
Touch-N-Mow™ Starter	5 years	90 days	Equipped on Quantum® or Intek™ engines

\*\*Engines used on Home Standby Generator applications are warranted under consumer use only. This warranty does not apply to engines on equipment used for prime power in place of a utility. **Engines used in competitive racing or on commercial or rental tracks are not warranted.**

The warranty period begins on the date of purchase by the first retail consumer or commercial end user, and continues for the period of time stated in the table above. "Consumer use" means personal residential household use by a retail consumer. "Commercial use" means all other uses, including use for commercial, income producing or rental purposes. Once an engine has experienced commercial use, it shall thereafter be considered as a commercial use engine for purposes of this warranty.

No warranty registration is necessary to obtain warranty on Briggs & Stratton products. Save your proof of purchase receipt. If you do not provide proof of the initial purchase date at the time warranty service is requested, the manufacturing date of the product will be used to determine the warranty period.

## ABOUT YOUR ENGINE WARRANTY

Briggs & Stratton welcomes warranty repair and apologizes to you for being inconvenienced. Any Authorized Service Dealer may perform warranty repairs. Most warranty repairs are handled routinely, but sometimes requests for warranty service may not be appropriate. For example, warranty would not apply if engine damage occurred because of misuse, lack of routine maintenance, shipping, handling, warehousing or improper installation. Similarly, warranty is void if the serial number of the engine has been removed or the engine has been altered or modified.

If a customer differs with the decision of the Service Dealer, an investigation will be made to determine whether the warranty applies. Ask the Service Dealer to submit all supporting facts to his Distributor or the Factory for review. If the Distributor or the Factory decides that the claim is justified, the customer will be fully reimbursed for those items that are defective. To avoid misunderstanding which might occur between the customer and the Dealer, listed below are some of the causes of engine failure that the warranty does not cover.

### Normal wear:

Engines, like all mechanical devices, need periodic parts service and replacement to perform well. Warranty will not cover repair when normal use has exhausted the life of a part or an engine.

### Improper maintenance:

The life of an engine depends upon the conditions under which it operates, and the care it receives. Some engines are used in dusty or dirty conditions, which can cause premature wear. Wear caused by dirt, dust, or other abrasive material that has entered the engine because of improper maintenance, is not covered by warranty.

This warranty covers engine related defective material and/or workmanship only, and not replacement or refund of the equipment to which the engine may be mounted. Nor does the warranty extend to repairs required because of:

1. PROBLEMS CAUSED BY PARTS THAT ARE NOT ORIGINAL BRIGGS & STRATTON PARTS.
2. Equipment controls or installations that prevent starting, cause unsatisfactory engine performance, or shorten engine life. (Contact equipment manufacturer.)
3. Leaking carburetors, clogged fuel pipes, sticking valves, or other damage, caused by using contaminated or stale fuel.
4. Parts which are scored or broken because an engine was operated with insufficient or contaminated lubricating oil, or an incorrect grade of lubricating oil (Check and refill when necessary, and change at recommended intervals.) OIL GARD® may not shut down running engine. Engine damage may occur if oil level is not properly maintained.
5. Repair or adjustment of associated parts or assemblies such as clutches, transmissions, remote controls, etc., which are not manufactured by Briggs & Stratton.
6. Damage or wear to parts caused by dirt, which entered the engine because of improper air cleaner maintenance, re-assembly, or use of a non-original air cleaner element or cartridge. At recommended intervals, clean and/or replace the filter as stated in the Operator's Manual.
7. Parts damaged by over-speeding, or overheating caused by grass, debris, or dirt, which plugs or clogs the cooling fins, or flywheel area, or damage caused by operating the engine in a confined area without sufficient ventilation. Clean engine debris at recommended intervals as stated in the Operator's Manual.
8. Engine or equipment parts broken by excessive vibration caused by a loose engine mounting, loose cutter blades, unbalanced blades or loose or unbalanced impellers, improper attachment of equipment to engine crankshaft, over-speeding or other abuse in operation.
9. A bent or broken crankshaft, caused by striking a solid object with the cutter blade of a rotary lawn mower, or excessive v-belt tightness.
10. Routine tune-up or adjustment of the engine.
11. Engine or engine component failure, i.e., combustion chamber, valves, valve seats, valve guides, or burned starter motor windings, caused by the use of alternate fuels such as, liquified petroleum, natural gas, altered gasolines, etc.

Warranty service is available only through authorized service dealers by Briggs & Stratton Corporation. Locate your nearest Authorized Service Dealer in our dealer locator map on [www.briggsandstratton.com](http://www.briggsandstratton.com) or by calling 1-800-2333723, or as listed in the 'Yellow Pages™'.