



Operating & Maintenance Instructions

Model Series Covered in This Manual Include Gasoline, Natural Gas and Liquid Propane Gas Engines

210000
280000
310000



Model	Type	Code
<input type="text"/>	<input type="text"/>	<input type="text"/>

Note: General Model Series numbers noted above are inclusive of the specific model number found on your engine. To get replacement parts or technical assistance in the future, write your engine Model, Type, Code and date of purchase here.

Month/	Day/	Year
<input type="text"/>	<input type="text"/>	<input type="text"/>

TABLE OF CONTENTS

Safety	3-5
Engine Information	6
Oil	7
Fuel and Starting Information	8
Starting and Stopping	9-10
Maintenance	11-15
Parts and Service & Storage	16
Warranty Information	17



WARNING

Briggs & Stratton does not approve or authorize the use of these engines on 3-wheel All Terrain Vehicles (ATVs), motor bikes, aircraft products or vehicles intended for use in competitive events. Use of these engines in such applications could result in property damage, serious injury (including paralysis), or even death.

Need assistance? Go to www.briggsandstratton.com for detailed information regarding Briggs & Stratton engines.
Or call, **1-800-233-3723**, (U.S.A. and Canada) to hear a menu of pre-recorded messages offering engine maintenance information.



The Power That Works For You.™

Look For Relevant Emissions Durability Period and Air Index Information On Your Engine Emissions Label

Engines that are certified to meet the California Air Resources Board (CARB) Tier 2 Emission Standards must display information regarding the Emissions Durability Period and the Air Index. Briggs & Stratton makes this information available to the consumer on our emission labels.

The **Emissions Durability Period** describes the number of hours of actual running time for which the engine is certified to be emissions compliant, assuming proper maintenance in accordance with the Operating & Maintenance Instructions. The following categories are used:

- Moderate:** Engine is certified to be emission compliant for 125 hours of actual engine running time.
- Intermediate:** Engine is certified to be emission compliant for 250 hours of actual engine running time.
- Extended:** Engine is certified to be emission compliant for 500 hours of actual engine running time.

For example, a typical walk-behind lawn mower is used 20 to 25 hours per year. Therefore, the **Emissions Durability Period** of an engine with an **intermediate** rating would equate to 10 to 12 years.

The **Air Index** is a calculated number describing the relative level of emissions for a specific engine family. The lower the **Air Index**, the cleaner the engine. This information is displayed in graphical form on the emissions label.

After July 1, 2000, Look For Emissions Compliance Period On Engine Emissions Compliance Label

After July 1, 2000 certain Briggs & Stratton engines will be certified to meet the United States Environmental Protection Agency (USEPA) Phase 2 emission standards. For Phase 2 certified engines, the Emissions Compliance Period referred to on the Emissions Compliance label indicates the number of operating hours for which the engine has been shown to meet Federal emission requirements. For engines less than 225 cc displacement, Category C = 125 hours, B = 250 hours and A = 500 hours. For engines of 225 cc or more, Category C = 250 hours, B = 500 hours and A = 1000 hours.

The displacement engines of Model Series 210000 is 344 cc, 280000 is 465 cc, 310000 engines is 501 cc.

This is a generic representation of the emission label typically found on a certified engine.

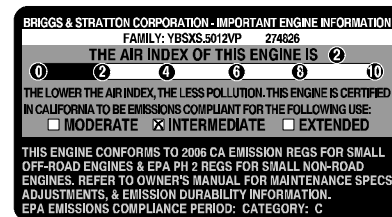



BEFORE OPERATING ENGINE

- Read entire Operating & Maintenance Instructions AND the instructions for the equipment this engine powers.*
- Failure to follow instructions could result in serious injury or death.

THE OPERATING & MAINTENANCE INSTRUCTIONS CONTAIN SAFETY INFORMATION TO

- Make you aware of hazards associated with engines
- Inform you of the risk of injury associated with those hazards, and
- Tell you how to avoid or reduce the risk of injury.

The safety alert symbol () is used to identify safety information about hazards that can result in personal injury.



A signal word (DANGER, WARNING, or CAUTION) is used with the alert symbol to indicate the likelihood and the potential severity of injury. In addition, a hazard symbol may be used to represent the type of hazard.

 **DANGER** indicates a hazard which, if not avoided, **will result in death or serious injury.**









 **WARNING** indicates a hazard which, if not avoided, **could result in death or serious injury.**

 **CAUTION** indicates a hazard which, if not avoided, **might result in minor or moderate injury.**









CAUTION, when used **without** the alert symbol, indicates a situation that **could result in damage to the engine.**

 WARNING 
The engine exhaust from this product contains chemicals known to the State of California to cause cancer, birth defects, or other reproductive harm.

HAZARD SYMBOLS AND MEANINGS

 Fire	 Explosion	 Moving Parts
 Toxic Fumes	 Hot Surface	 Shock
 Wear Eye Protection	 Kickback	 Frostbite

THE INTERNATIONAL SYMBOLS USED ON THE ENGINE OR IN THIS MANUAL INCLUDE:

 Safety Alert	 Read Owner's Manual	 On Off
 Oil	 Stop	 Fuel Shutoff
	 Choke	 Fuel

* Briggs & Stratton does not necessarily know what equipment this engine will power. For that reason, you should carefully read and understand the operating instructions for the equipment on which your engine is placed.

**WARNING**

Fuel and its vapors are extremely flammable and explosive.



Fire or explosion can cause severe burns or death.

WHEN FUELING

- Turn engine OFF and let engine cool at least 2 minutes before removing cap or refueling engine.
- Fill fuel tank outdoors or in well-ventilated area.
- On **GASOLINE** operated engines, do not overfill fuel tank. Fill tank to approximately 1-1/2 inches below top of neck to allow for fuel expansion.
- Keep fuel away from sparks, open flames, pilot lights, heat, and other ignition sources.
- Check fuel lines, tank, cap, and fittings frequently for cracks or leaks. Replace if necessary.

WHEN STARTING ENGINE

- Make sure spark plug, muffler, fuel cap and air cleaner are in place, and firmly secured by equipped fasteners.
- Do not crank engine with spark plug, air cleaner cartridge or air cleaner cover removed.
- If fuel spills, wait until it evaporates before starting engine.
- If **GASOLINE** engine floods, set choke to OPEN/RUN position, place throttle in FAST and crank until engine starts.

WHEN OPERATING EQUIPMENT

- Do not tip engine or equipment at angle which causes gasoline to spill.
- Do not choke carburetor to stop engine.

WHEN TRANSPORTING EQUIPMENT

- On **GASOLINE** engine, transport with fuel tank EMPTY or with fuel shut-off valve OFF.
- On **NATURAL / LIQUID PETROLEUM (LP) GAS** engines transport with fuel cylinder empty or valve closed, or tank disconnected.

WHEN STORING GASOLINE OR EQUIPMENT WITH FUEL IN TANK

- Store away from furnaces, stoves, water heaters or other appliances that have pilot light or other ignition source because they can ignite gasoline vapors.

**WARNING**

Gaseous fuels are extremely flammable and readily form explosive air-vapor mixtures at ambient temperatures.

**IF YOU SMELL GAS:**

- DO NOT start the engine.
- DO NOT actuate any electrical switches.
- DO NOT use the phone in the vicinity.
- Evacuate the area.
- Contact the gas supplier or fire department.

REMEMBER:

- LPG vapor is heavier than air and trends to collect in low areas. NG vapor is lighter than air and tends to collect in high areas. Both may travel to remote locations.
- Keep all flames, sparks, pilot lights, and other ignition sources away from the area where the engine is operated or repaired.
- DO NOT smoke when operating or repairing the engine.
- DO NOT store gasoline or other flammable vapors or liquids in the vicinity of the engine.
- BEFORE doing any service work to the engine, shut off the gas supply.
- After initial installation or servicing, check for gas leaks. DO NOT use an open flame. Apply very soapy water or leak test solution with a brush and look for bubbles.
- Keep the equipment and the area surrounding the engine free of debris.
- Install the fuel system according to applicable fuel/gas codes.

**WARNING**

Wear eye protection when doing repair work.



Frostbite can result from skin/eye contact with leaking LP liquid.

- Installation, adjustment and repair work should be done by a qualified technician.
- Flexible supply lines should be checked regularly to make sure they are in good condition. Replace damaged or leaking components.

WARNING

Starting engine creates sparking.
Sparking can ignite nearby flammable gases.
Explosion and fire could result.

- If there is natural or LP gas leakage in area, do not start engine.
- Do not use pressurized starting fluids because vapors are flammable.

WARNING

Rapid retraction of starter cord (kickback) will pull hand and arm toward engine faster than you can let go.
Broken bones, fractures, bruises or sprains could result.

- When starting engine, pull cord slowly until resistance is felt, then pull rapidly.
- Remove all external equipment/engine loads before starting engine.
- Direct coupled equipment components such as, but not limited to, blades, impellers, pulleys, sprockets, etc., must be securely attached.

WARNING

Rotating parts can contact or entangle hands, feet, hair, clothing, or accessories.
Traumatic amputation or severe laceration can result.

- Operate equipment with guards in place.
- Keep hands and feet away from rotating parts.
- Tie up long hair and remove jewelry.
- Do not wear loose-fitting clothing, dangling drawstrings or items that could become caught.

WARNING

Engines give off carbon monoxide, an odorless, colorless, poison gas.
Breathing carbon monoxide can cause nausea, fainting or death.

- Start and run engine outdoors.
- Do not start or run engine in enclosed area, even if doors or windows are open.

WARNING

Running engines produce heat. Engine parts, especially muffler, become extremely hot.
Severe thermal burns can occur on contact.
Combustible debris, such as leaves, grass, brush, etc. can catch fire.

- Allow muffler, engine cylinder and fins to cool before touching.
- Remove accumulated combustibles from muffler area and cylinder area.
- Install and maintain in working order a spark arrester before using equipment on forest-covered, grass-covered, brush-covered unimproved land. The state of California requires this (Section 4442 of the California Public Resources Code). Other states may have similar laws. Federal laws apply on federal land.

WARNING

Unintentional sparking can result in fire or electric shock.
Unintentional start-up can result in entanglement, traumatic amputation, or laceration.

BEFORE PERFORMING ADJUSTMENTS OR REPAIRS

- Disconnect spark plug wire and keep it away from spark plug.
- Disconnect battery at negative terminal (only engines with electric start).

WHEN TESTING FOR SPARK

- Use approved spark plug tester.
- Do not check for spark with spark plug removed.

ENGINE INFORMATION

BRIGGS & STRATTON

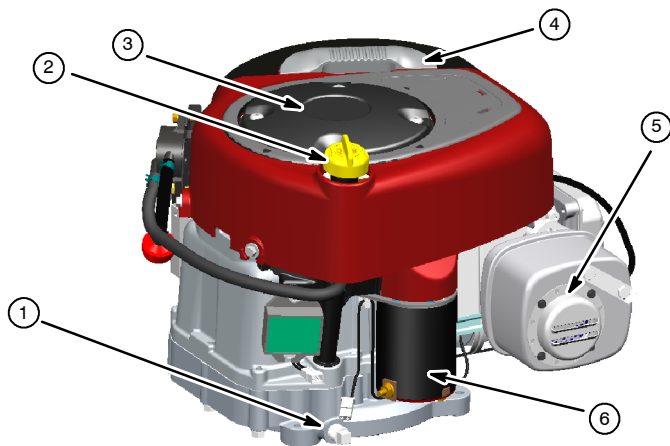

1. Oil drain
2. Oil fill/Dipstick
3. Rotating screen
4. Air cleaner handle
5. Muffler/(Muffler guard (if equipped)/ Spark arrester, if equipped)
6. 12 V electric starter (if equipped)
7. Rewind starter handle (if equipped)

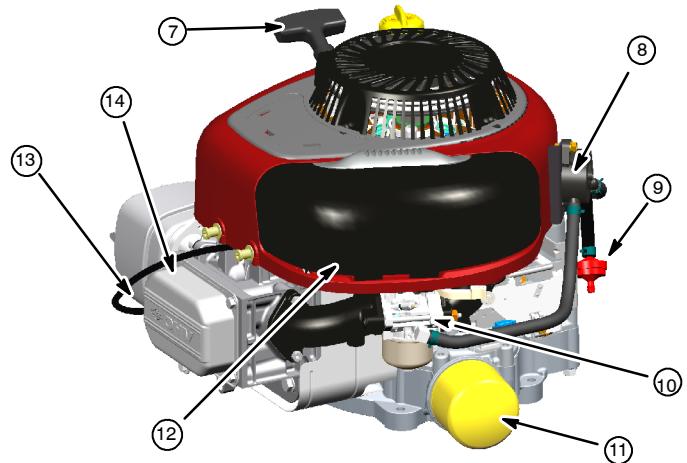

8. Fuel pump (if equipped)
9. In-line fuel filter (if equipped)
10. Carburetor or LPG / NG Mixer
11. Oil filter (if equipped)
12. Air cleaner cover
13. Spark plug wire
14. Engine

Model	Type	Code
xxxxx	xxxx xx	xxxxxxxx

GENERAL INFORMATION

ENGINE MODEL: This is a single cylinder, overhead valve (OHV), air-cooled engine. It is a low emissions engine.

In the state of California, OHV Model Series 210000, 280000 and 310000 engines are certified by the California Air Resources Board to meet emissions standards for 250 hours. Such

certification does not grant the purchaser, owner or operator of this engine any additional warranties with respect to the performance or operational life of this engine. This engine is warranted solely according to the product and emissions warranties stated elsewhere in this manual.

TUNE-UP SPECIFICATIONS

Armature air gap	0.010 - 0.014 in. (0.25 - 0.36 mm)
Spark plug gap	0.030 in. (0.76 mm)
Valve clearance with valve springs installed and piston 1/4 in. (6 mm) past top dead center (check when engine is cold). See Repair Manual P/N 272147.		
Intake	0.003 - 0.005 in. (0.08 - 0.13 mm)
Exhaust	0.005 - 0.007 in. (0.13 - 0.18 mm)

MODEL SERIES 210000

Bore	3.44 in. (87.31 mm)
Stroke	2.27 in. (57.66 mm)
Displacement	21 cu. in. (344 cc)

MODEL SERIES 280000

Bore	3.44 in. (87.31 mm)
Stroke	3.06 in. (77.78 mm)
Displacement	28.42 cu. in. (466 cc)

MODEL SERIES 310000

Bore	3.56 in. (90.60 mm)
Stroke	3.06 in. (77.78 mm)
Displacement	30.59 cu. in. (501 cc)

Note: For practical operation, the horsepower loading should not exceed 85% of rated horsepower. Engine power will decrease 3-1/2% for each 1,000 feet (300 meters) above sea level and 1% for each 10° F (5.6° C) above 77° F (25° C). Engine will operate satisfactorily at an angle up to 15°.

TECHNICAL INFORMATION

POWER RATINGS: The power ratings for an individual engine model are initially developed by starting with SAE (Society of Automotive Engineers) code J1940 (Small Engine Power & Torque Rating Procedure) (Revision 2002-05). Given both the wide array of products on which our engines are placed, and the variety of environmental issues applicable to operating the equipment, it may be that the engine you have purchased will not develop the rated horsepower when used in a piece of power equipment (actual "on-site" power). This difference is due to a variety of factors including, but not limited to, the following:

differences in altitude, temperature, barometric pressure, humidity, fuel, engine lubrication, maximum governed engine speed, individual engine to engine variability, design of the particular piece of power equipment, the manner in which the engine is operated, engine run-in to reduce friction and clean out of combustion chambers, adjustments to the valves and carburetor, and other factors. The power ratings may also be adjusted based on comparisons to other similar engines utilized in similar applications, and will therefore not necessarily match the values derived using the foregoing codes.



CAUTION: This engine is shipped from Briggs & Stratton **without oil**. Check oil level before starting engine. If you start the engine without oil, the engine will be damaged beyond repair and will not be covered under warranty.

OIL CAPACITY

Engine without oil filter holds approximately 1-1/2 quarts (48 ounces; 1.4 liters).

TYPE OF OIL TO USE

- Use a high quality detergent oil classified “For Service SF, SG, SH, SJ” or higher, such as Briggs & Stratton 30W, Part Number 100005 (20 oz) or 100028 (48 oz).
- Do not use special additives.
- Choose a viscosity according to the table opposite.



Note: Synthetic oil meeting ILSAC GF-2, API certification mark and API service symbol (shown at left) with “SJ/CF ENERGY CONSERVING” or higher, is an acceptable oil at all temperatures. **Use of synthetic oil does not alter required oil change intervals.**

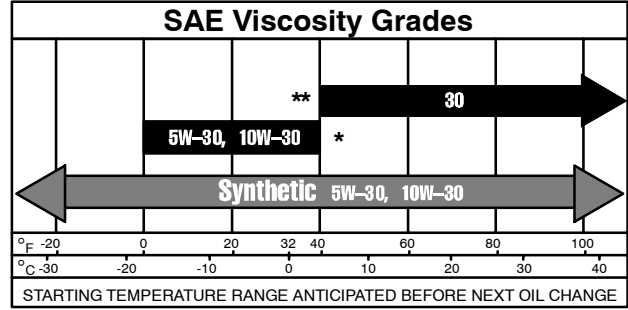

- * **CAUTION:** Air cooled engines run hotter than automotive engines. The use of non-synthetic multi-viscosity oils (5W-30, 10W-30, etc.) in temperatures above 40° F (4° C) will result in higher than normal oil consumption. When using a multi-viscosity oil, check oil level more frequently.
- ** **CAUTION:** SAE 30 oil, if used below 40° F (4° C), will result in hard starting and possible engine bore damage due to inadequate lubrication.

CHECKING AND ADDING OIL

- Check oil level **before** starting the engine.
- Check level daily, or after every eight (8) hours.
- Keep oil level at FULL.
- Do not overfill.

- [1] Place engine level and clean around oil fill area.
- [2] Remove dipstick and wipe clean with cloth.
- [3] Replace and tighten dipstick. Remove and check oil level.
- [4] Oil level should be at FULL line on dipstick.
- [5] If needed, add oil slowly - recheck. Do not over fill.
- [6] Replace and tighten dipstick.



TYPE OF FUEL TO USE

GASOLINE POWERED ENGINES

- Use clean, fresh, regular unleaded gasoline with a minimum of 85 octane. Fresh fuel prevents gum from forming in the fuel system or on essential carburetor parts. Purchase fuel in quantity that can be used within 30 days.
- Do not use gasoline which contains Methanol.
- Do not mix oil with gasoline.
- For engine protection use Briggs & Stratton Gasoline Additive available from your Authorized Briggs & Stratton Dealer (P/N 5041 or single use pouch).
- The gasoline engine is certified to operate on gasoline. Exhaust Emission Control System: EM (Engine Modifications).

CAUTION: Some fuels, called oxygenated or reformulated gasoline, are gasoline blended with alcohols or ethers. Excessive amounts of these blends can damage the fuel system or cause performance problems. If any undesirable operating symptoms occur, use gasoline with a lower percentage of alcohol or ether.

NATURAL / LIQUID PROPANE GAS POWERED ENGINES

- Use clean, dry fuel, free of moisture or any particulate material. Using fuels outside the following recommended values may cause performance problems.
- In engines set up to run on LPG, commercial grade HD5 LPG is recommended. Recommended fuel composition is fuel with a minimum fuel energy of 2500 BTU's/ft³ with maximum propylene content of 5% and butane and heavier gas content of 2.5% and minimum propane content of 90%.
- NG or LPG engines are certified to operate on natural or liquid propane gas.

WARNING

The equipment on which this engine is mounted is equipped with an automatic safety gas “fuel lock-off” valve. DO NOT operate the equipment if the “fuel lock-off” valve is missing or inoperative.

ADDING FUEL

GASOLINE POWERED ENGINES

WARNING

- Turn engine OFF and let engine cool at least 2 minutes before removing gas cap.
- Fill fuel tank outdoors or in well-ventilated area.
- Keep gasoline away from sparks, open flames, pilot lights, heat, and other ignition sources.
- If fuel spills, wait until it evaporates before starting engine.

NATURAL / LIQUID PROPANE GAS POWERED ENGINES

- Read the operating instructions supplied by the equipment manufacturer for information on refueling natural or LP gas engine.

[1] Remove cap. Fill tank to approximately 1-1/2 inches below top of neck to allow for fuel expansion. Be careful not to overfill.

[2] Replace cap before starting.

	WARNING
	<ul style="list-style-type: none"> • Do not use pressurized starting fluids. • Vapors are flammable.

	WARNING
	<ul style="list-style-type: none"> • DO NOT start engine with air filter or cover not properly installed. Serious injury or death could result from backfire.

OIL PRESSURE SWITCH

If engine is equipped with an oil pressure switch, the switch will either activate a warning light or stop the engine when the engine runs low on oil. (Read the operating instructions supplied by the equipment manufacturer to determine which way your engine is equipped because the equipment manufacturer supplies the oil pressure gauge.)

STARTING AND OPERATING TIPS

- ◆ Store and fuel equipment in level position.
- ◆ Use fresh fuel. (See Fuel.)
- ◆ Use correct type of oil for expected starting temperature. (See Oil.)
- ◆ Remove external equipment/engine loads. (See equipment operating instructions.)
- ◆ Start lawn mower on hard surface or over previously cut grass.
- ◆ Periodically remove grass buildup under mower deck. (See Maintenance.)
- ◆ After engine has started, let it warm up several seconds to several minutes, depending on outside temperature.
- ◆ For maximum performance and life, operate engine with choke in RUN and throttle in FAST.

BEFORE STARTING

GASOLINE POWERED ENGINES

- [1] Check oil level.
- [2] Open fuel shut-off valve (if equipped).

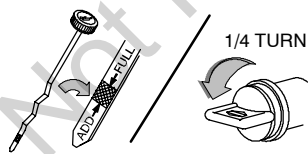

- [3] If choke and throttle controls are separate, move choke control to CHOKE. Move throttle to FAST.

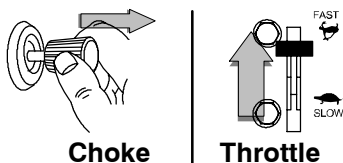

- [4] If choke and throttle are on the same control, move control to CHOKE or START.

Combined Choke/Throttle control

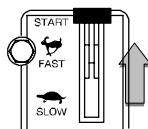

NATURAL / LIQUID PROPANE GAS POWERED ENGINES

- [1] Check oil level.

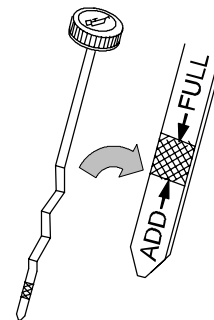

STARTING

BRIGGS & STRATTON

ELECTRIC (KEY) STARTER

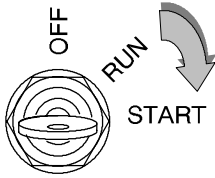

- [1] Insert key and turn to START.
- [2] Let engine warm up.
If choke equipped: Slowly adjust toward RUN position. Wait until engine runs smoothly before each choke adjustment.

CAUTION:

To prolong starter life, use short starting cycles (5 seconds maximum, then wait one minute). Follow equipment manufacturer's recommendations for charging battery.

REWIND (MANUAL) STARTER (auxiliary)

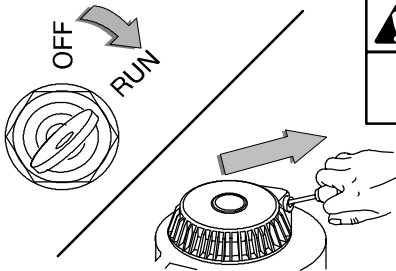

- [1] Insert key (if equipped) and turn to RUN.
- [2] Grasp rope handle. Pull slowly until resistance is felt, then pull rapidly to start engine and avoid kickback.
- [3] Let engine warm up.
If choke equipped: Slowly adjust toward RUN position. Wait until engine runs smoothly before each choke adjustment.

STOPPING

BRIGGS & STRATTON

CAUTION:

Do not stop engine by moving choke control to CHOKE. Backfire, fire or engine damage could occur.

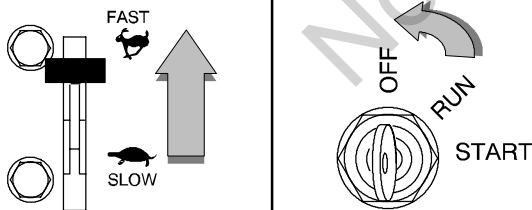
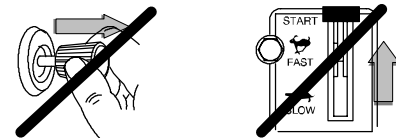

- [1] With throttle in FAST, turn key to OFF.
- [2] Remove key and store out of reach of children.
- [3] Close fuel shut-off valve (if equipped).

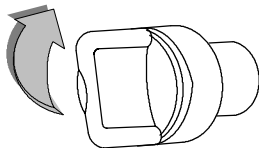

1/4 TURN



MAINTENANCE

Regular maintenance will improve the performance and extend the life of the engine. See any Authorized Briggs & Stratton Dealer for service. **Use only genuine Briggs & Stratton parts. Other parts may not perform as well, may damage the engine, and may result in injury.** In addition, use of other parts may void your warranty.

Task	Every 8 Hours or Daily	25 Hours or Every Season	50 Hours or Every Season	100 Hours or Every Season	200 Hours or Every Season	Yearly
<i>Perform task at hourly or calendar interval, whichever comes first.</i>						
Check Oil Level	✓					
Change Oil			✓*			
Change oil filter (if equipped)				✓*		
Service air cleaner pre-cleaner (if equipped)		✓**				
Replace air cleaner cartridge (if not equipped with pre-cleaner)		✓**				
Replace air cleaner cartridge (if equipped with pre-cleaner)				✓**		
Clean Extended Life Series™ air cleaner cartridge			✓**			
Replace Extended Life Series™ air cleaner cartridge					✓**	
Inspect spark arrester (if equipped)			✓			
Replace spark plug				✓		
Replace in-line fuel filter (if equipped)				✓		
Clean cooling system				✓**		
Check valve clearance						✓
Check valve clearance on NG / LPG Engines				✓		

* **Change oil after first 5 to 8 hours of use**, then every 50 hours or every season. Change oil every 25 hours when operating the engine under heavy load or in high temperatures.

** Clean more often under dusty conditions or when airborne debris is present. Replace air cleaner parts, if very dirty.

EMISSION CONTROL

Maintenance, replacement or repair of the emission control devices and systems may be performed by any nonroad engine repair establishment or individual. However, to obtain no charge repairs under the terms and provisions of the Briggs & Stratton warranty statement, any service or emission control part repair or replacement must be performed by a factory authorized dealer.

CHANGING OIL



5/16" HEX 3/8" SQUARE



7/16" PIPE

Typical drain plugs

TO REMOVE

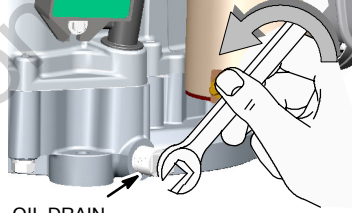

OIL DRAIN PLUG

WARNING

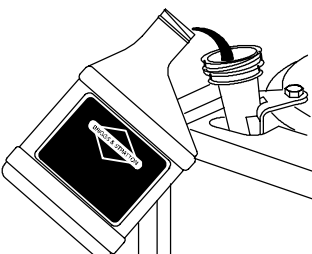
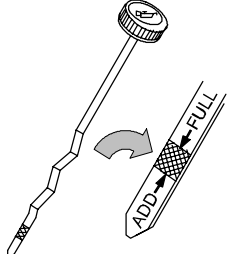

- [1] Place engine level.
- [2] Disconnect spark plug wire and keep away from spark plug. Disconnect battery (if equipped with electric starter) at negative terminal.
- [3] With engine OFF but still warm remove oil drain plug and drain oil into appropriate receptacle.
- [4] Reinstall drain plug. Remove dipstick.
- [5] Fill to FULL mark on dipstick with new oil. **Do not overfill.**
- [6] Replace dipstick.

CAUTION: Used oil is a hazardous waste product. Dispose of used oil properly. Do not discard with household waste. Check with your local authorities, service center, or dealer for safe disposal/recycling facilities.

AIR CLEANER

CAUTION: Do not use pressurized air or solvents to clean cartridge. Pressurized air can damage cartridge; solvents will dissolve cartridge.

FLAT AIR CLEANER REMOVAL/ INSTALLATION

- [1] Pull up on air cleaner cover handle, and rotate toward engine.
- [2] Remove air cleaner cover.
- [3] Carefully lift air cleaner cartridge and pre-cleaner, if equipped, from blower housing.

Note: To clean pre-cleaner, wash in soapy water. Squeeze dry in a clean cloth. **DO NOT OIL.**

- [4] Clean base of air cleaner cartridge area carefully to prevent debris from entering engine.
- [5] Place air cleaner pre-cleaner, if equipped, and cartridge into blower housing. Cartridge must fit securely in base.
- [6] Align tabs on cover with slots of blower housing and replace cover.
- [7] Hook handle and close cover.

WARNING



If filters, or covers are not installed correctly serious injury or death could result from backfire. Do not attempt to start your engine with them removed.

EXTENDED LIFE SERIES™ CARTRIDGE ONLY

This filter, IF STAMPED 'WASHABLE', can be washed with warm water and mild soap.

IMPORTANT:

Rinse in tap water with **SCREEN** side up allowing dirt and debris to filter out.

Leave filter to dry overnight before reinstalling.

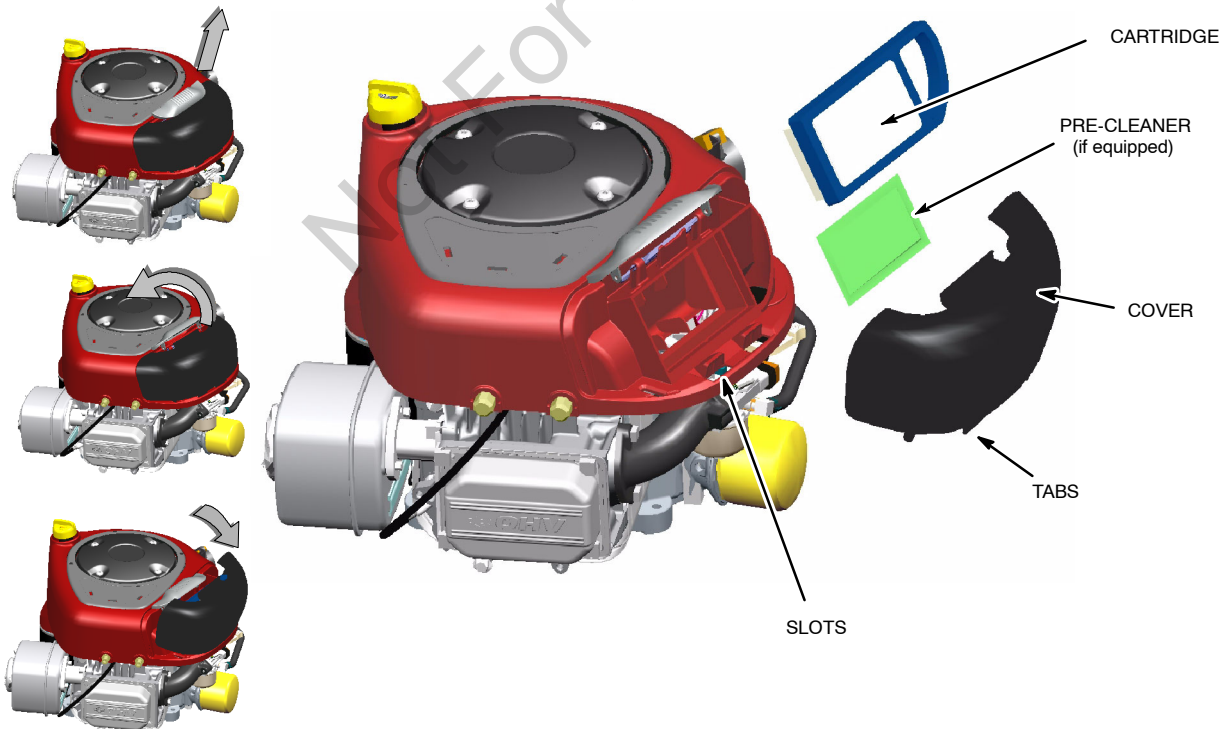
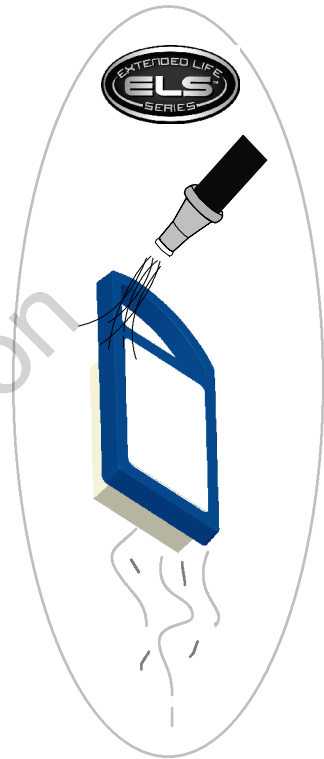



HIGH FLOW AIR CLEANER MAINTENANCE

Perform this maintenance every 25 hours or every season, clean more often under dusty conditions or when airborne debris is present. This filter is made of cotton, which is different from a standard paper filter, therefore it **MUST** be oiled.

- [1] Remove clamp and pull air cleaner from intake manifold.
- [2] Remove as much dirt from the filter as possible.
- [3] Using the High Flow Air Filter Cleaner Kit, Briggs & Stratton part no. 5089D, spray the filter with cleaner. Allow the solution to soak in to the filter for about 15 minutes.

CAUTION: Never use strong detergents, high pressure water, or gasoline to clean this filter.

- [4] Rinse the filter with warm water, inside first and then outside. (Let the water run from the clean side to the dirty side.)
- [5] Allow the filter to dry completely. It is best to allow the filter to dry naturally. Don't use heat, this might shrink the cotton.
- [6] Use only air filter oil, such as the oil included in the cleaning kit (P/N 5089D), to re-oil the filter.



WARNING

Never use motor oil, transmission fluid, WD40, or other oils. Failure to follow instructions can cause fires resulting in death or serious injury. Use only air filter oil designed specifically for air filters.

- [7] Spray the filter with oil, or pour small amount onto each pleat and allow filter to stand for 20 minutes. The filter is correctly oiled when the cotton changes from white to the color of the oil.

CAUTION: DO NOT over-oil air filter, it will interfere with engine performance and may cause engine damage. If the filter is placed on cardboard for 10 minutes and leaves a stain, it is over oiled. Wash/clean and re-oil per above instructions.

- [8] Re-install air filter.

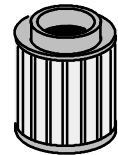
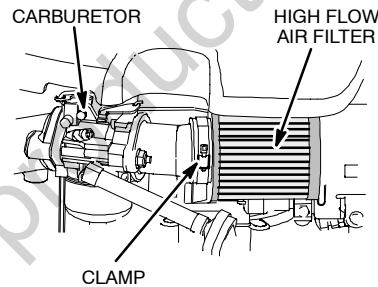

FILTER
P/N 698973

OIL FILTER (IF EQUIPPED)

Replace oil filter after every 100 hours of operation.

- [1] Drain engine oil and remove oil filter.
- [2] Before installing new filter, lightly oil filter gasket with fresh, clean engine oil.
- [3] Screw filter on by hand until gasket contacts oil filter adapter. Tighten 1/2 to 3/4 turn more.
- [4] Add fresh oil. Fill to FULL line on dipstick.
- [5] Start and run engine at idle to check for oil leaks.
- [6] Stop engine. Recheck oil level and add oil if required.

OIL PRESSURE

If oil pressure drops too low, an oil pressure switch (if engine is equipped) will either activate a warning light or stop the engine. Check oil level with dipstick. If oil level is between **ADD** and **FULL** mark on dipstick, Do not try to restart engine. Contact an Authorized Briggs & Stratton Service Dealer. Do not operate engine until oil pressure is corrected.

If oil level is below **ADD** mark on dipstick, add oil to bring level to **FULL** mark. Restart engine and check oil pressure. If pressure is normal, continue to operate engine.

Note: Oil pressure gauge, if engine is equipped, is supplied by manufacturer of equipment.

ENGINE AND ENGINE PARTS

We recommend that you see an authorized Briggs & Stratton Service Dealer for all maintenance and service of the engine and engine parts. Use only genuine Briggs & Stratton parts.

WARNING

WARNING

If you perform any maintenance on the engine, first disconnect the spark plug wire from the spark plug, and disconnect the battery at the negative terminal (electric starter engines only) to prevent unintentional sparking. Unintentional sparking can result in fire or electric shock. Unintentional start-up can result in entanglement, traumatic amputation or laceration. Use only correct tools.

- Do not strike the flywheel with a hammer or hard object because the flywheel may later shatter during operation.
- Do not tamper with governor spring, links or other parts to increase engine speed.

MUFFLER

WARNING

Replacement parts for the muffler must be the same and installed in the same position as the original parts, otherwise fire can occur.

If muffler is equipped with spark arrester screen, remove screen for inspection. Replace screen if damaged or plugged.

SPARK PLUG

Use only Briggs & Stratton Spark Tester (part number 19368) to check for spark.

Check the spark plug every season. Replace the spark plug if upon inspection the electrodes are burned or worn. Ensure the spark plug is clean. Check the gap with a feeler gage and reset to 0.30 in. (0.76 mm) if necessary.

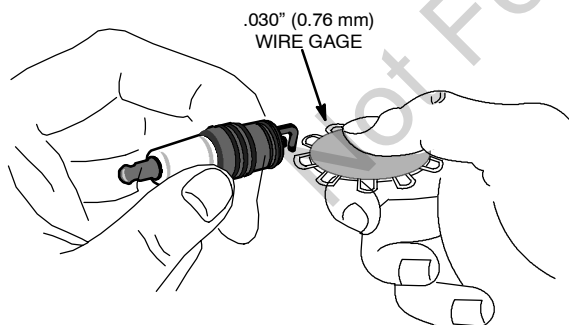

Note: In some areas, local law requires using resistor spark plug to suppress ignition signals. If this engine was originally equipped with resistor spark plug, use same type for replacement.

REPLACE FUEL FILTER (if equipped)

WARNING

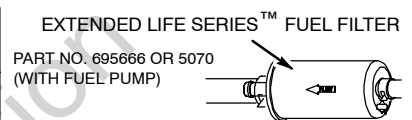

Drain fuel tank or close fuel shut-off valve before replacing fuel filter. Otherwise, fuel can leak out, creating a fire/explosion hazard.

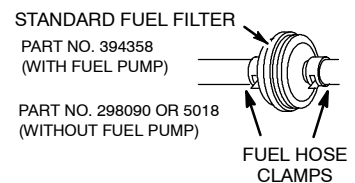

AIR COOLING SYSTEM

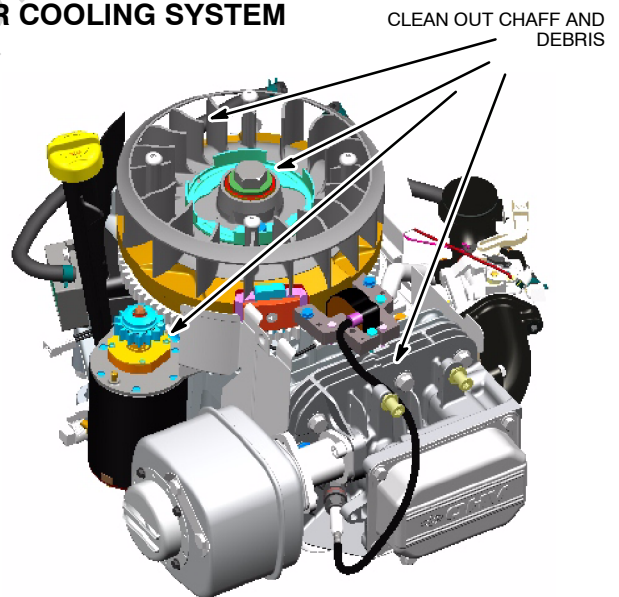

Debris may clog the engine's air cooling system. Remove blower housing and clean area shown to prevent overheating and engine damage.

CLEANING DEBRIS

WARNING Engine parts should be kept clean to reduce the risk of overheating and ignition of accumulated debris. This is especially important if cutting tall grass.

CAUTION: Do not use water to clean engine parts. Water could contaminate fuel system. Use a brush or dry cloth.

Daily or before every use, clean grass, chaff or accumulated debris from engine. Keep linkage, spring and controls clean. Keep area around and behind muffler free of any combustible debris.

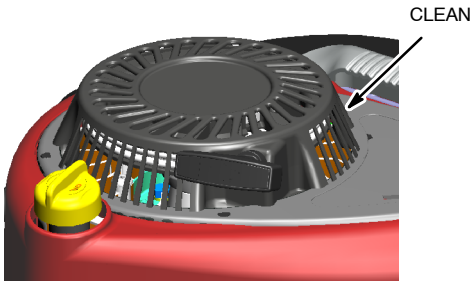

Finger Guard

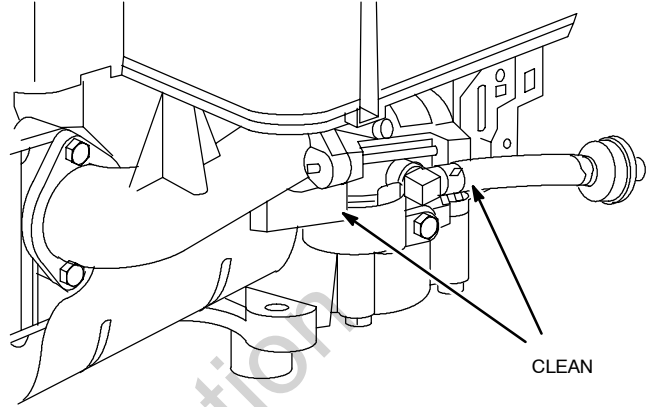

Linkage, Springs, Controls

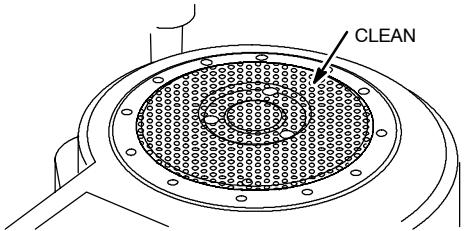

Rotating Screen

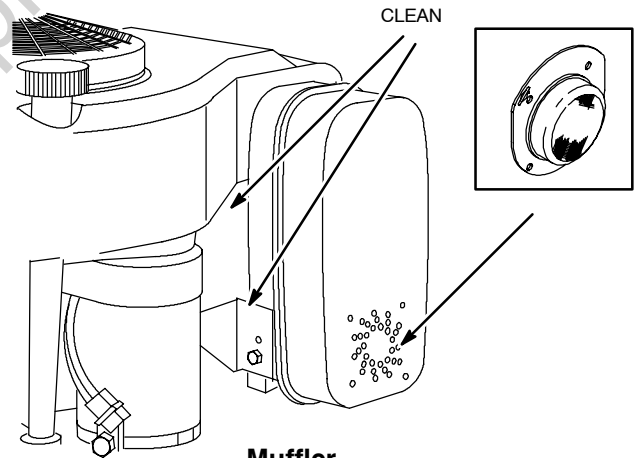

Muffler, Spark Arrester

SERVICE & STORAGE

BRIGGS & STRATTON

PARTIAL LIST OF BRIGGS & STRATTON PARTS

Models 280000, 310000 AVS™ series

Extended Life Series™ flat air cleaner cartridge 697153
(washable, no pre-cleaner required)

Extended Life Series™ Maintenance Kit 5128
(Includes oil, A/C filter, spark plug, gas additive)

Flat air cleaner cartridge and pre-cleaner kit 5077

Flat air cleaner cartridge 698083

Flat air cleaner pre-cleaner 697015

Maintenance Kit 5127
(Includes oil, A/C filter, spark plug, gas additive)

UL Approved flat air cleaner cartridge 790263
(For NG/LPG Gaseous Fuel engines.)

Model 210000 AVS™ series

Flat air cleaner cartridge and pre-cleaner kit 5079

Flat air cleaner cartridge 698413

Flat air cleaner pre-cleaner 697292

Maintenance Kit 5126
(Includes oil, A/C filter, spark plug, gas additive)

Oval air cleaner cartridge and pre-cleaner kit 5053

Oval air cleaner cartridge 496894

Oval air cleaner pre-cleaner 272403

High Flow Air Filter (cylinder) 698973

High Flow Air Filter Cleaning Kit 5089D

Synthetic Oil (32 oz.) 100074

Oil (20 oz.) 100005

Oil (48 oz.) 100028

Oil filter (3-1/2 in. long) 491056

Oil filter (2-1/4 in. long) 492932

Fuel filter 298090 -or- 5018
(for engines without fuel pump installed)

Extended Life Series™ fuel filter 695666 -or- 5070
(for engines equipped with fuel pump)

Fuel filter 394358
(for engines equipped with fuel pump)

Gas additive 5041

Resistor spark plug 491055

Long life platinum spark plug 5066
(used on most OHV engines)

Spark plug wrench 89838 -or- 5023

Spark tester 19368

Oil pump kit 5056
(uses standard electric drill to remove oil from engine quickly)

SERVICE

See an Authorized Briggs & Stratton Service Dealer. Each one carries a stock of Genuine Briggs & Stratton Parts and is equipped with special service tools. Trained mechanics assure expert repair service on all Briggs & Stratton engines. Only dealers advertising as "Authorized Briggs & Stratton" are required to meet Briggs & Stratton standards.

When you purchase equipment powered by a Briggs & Stratton engine, you are assured of highly skilled, reliable service at more than 30,000 Authorized Service Dealers worldwide, including more than 6,000 Master Service Technicians. Look for these signs wherever Briggs & Stratton service is offered.



You may locate your nearest Authorized Briggs & Stratton Service Dealer in our dealer locator map on our web site www.briggsandstratton.com or in the "Yellow Pages™"

directory under "Engines, Gasoline" or "Gasoline™ Engines," or "Lawn Mowers" or similar category.

Note: Walking fingers logo and "Yellow Pages" are registered trademarks in various jurisdictions.

An illustrated shop manual includes common specifications and detailed information covering adjustment, tune-up and repair of Briggs & Stratton single cylinder, OHV, 4 cycle engines. It is available for purchase from an Authorized Briggs & Stratton Service Dealer or you can order it from the factory. Write:

Briggs & Stratton Corporation
Attn: Service Division
P. O. Box 1144
Milwaukee, WI 53201

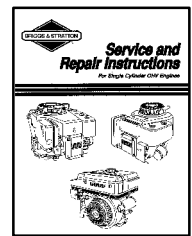

Part No. 272147

STORAGE

Engines stored over 30 days need special attention.

- [1] To prevent gum from forming in fuel system or on essential carburetor parts:
 - a) if fuel tank contains oxygenated or reformulated gasoline (gasoline blended with an alcohol or an ether), run engine until it stops from lack of fuel, **or** b) if fuel tank contains gasoline, either run engine until it stops from lack of fuel, or add a gasoline additive to the gas in the tank. (See parts list. Single - use pouches of gas additive are available from your service dealer.) If you use a gas additive, run the engine for several minutes to circulate the additive through the carburetor. Then, engine and fuel can be stored up to 24 months.
- [2] While engine is still warm, change oil.
- [3] Remove spark plug and pour about 1 oz. (30 ml) of engine oil into cylinder. Replace spark plug and crank slowly to distribute oil.
- [4] Clean engine of surface debris, chaff or grass.

[5]



Store in a clean, dry area. Do not store in same area as a stove, furnace, water heater, or other appliance that uses a pilot light or has a device that can create a spark.