

Operating Instructions

MODEL "Y"

Adjustment and Repair Information Parts List

IMPORTANT
ALWAYS USE
GOOD, CLEAN OIL
S.A.E. No. 20
ADD OIL FREQUENTLY
CHANGE OIL REGULARLY

IMPORTANT
ALWAYS USE
GOOD, CLEAN OIL
S.A.E. No. 20
ADD OIL FREQUENTLY
CHANGE OIL REGULARLY

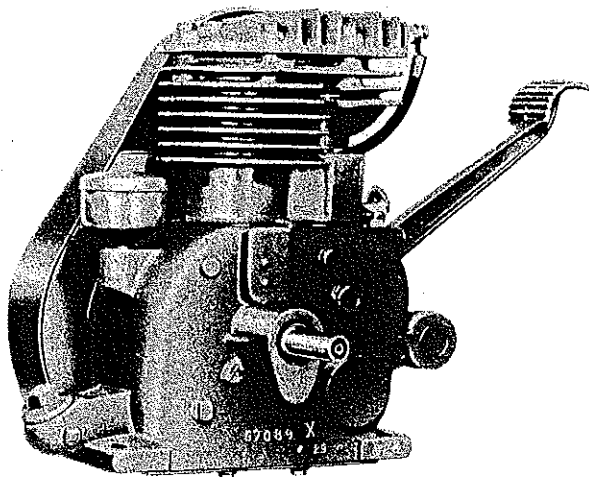

INDEX

	Page
Starting the "Y" Motor.....	2
Servicing Reference Chart.....	3
Instructions for Adjustment and Repair.....	3
Repair Parts.....	9
Guarantee.....	9
Parts List, Model "Y".....	10-13
Illustrated Parts.....	14
Nation-Wide Service Organization.....	15
Authorized Central Service Distributors.....	15

Read these instructions carefully before operating this Motor for the first time.

Guessing how to run it may cause you unnecessary inconvenience, aggravation or failure to receive the fine service that is built into it.

There is a right way to operate the "Y" Motor. This book tells you how.

Each Model "Y" motor is carefully tested and adjusted at the factory before packing for shipment, and if correctly operated will perform beyond your expectations.

DO NOT START THIS MOTOR UNTIL YOU HAVE READ CAREFULLY "STARTING AND OPERATING THE MODEL "Y" MOTOR" ON PAGE 2



IMPORTANT SAFETY INFORMATION AND INSTRUCTIONS FOR ENGINE SELECTION ENGINE INSTALLATION ENGINE OPERATION

In the USA and Canada,
our 24 hour hotline is:

18002333723

Briggs & Stratton Corporation
Milwaukee, Wisconsin 53201

www.briggsandstratton.com

Keep these instructions for future reference.



Before installing and operating this engine read and observe all warnings, cautions and instructions on both sides of this sheet, on the engine, and in the operating & maintenance instructions.

NOTE: This sheet of instructions and safety information is not meant to cover all possible conditions and situations that may occur. Read entire Operating & Maintenance Instructions for this engine AND the instructions for the equipment this engine powers. Failure to follow instructions and safety information could result in serious injury or death.

The safety alert symbol () is used to identify safety information about hazards that can result in personal injury.

A signal word (DANGER, WARNING, or CAUTION) is used with the alert symbol to indicate the likelihood and the potential severity of injury. In addition, a hazard symbol may be used to represent the type of hazard.

 **DANGER** indicates a hazard which, if not avoided, will result in death or serious injury.

 **WARNING** indicates a hazard which, if not avoided, could result in death or serious injury.

 **CAUTION** indicates a hazard which, if not avoided, might result in minor or moderate injury.

CAUTION, when used **without** the alert symbol, indicates a situation that **could result in damage to the engine.**

HAZARD SYMBOLS AND MEANINGS



Fire



Explosion



Moving Parts



Toxic Fumes



Hot Surface



Shock



Kickback

(OVER)

FORM MS-6445-01/03

ENGINE SELECTION

 WARNING

Failure to select the correct engine could result in fire or explosion.

- Some engines are unique and designed for specific applications or types of equipment. If this engine will be used to build new equipment, contact Briggs & Stratton to ensure that the engine is appropriate for the intended use.
Note: For all Go-karts use only a model 136200 series engine, which offers improved safety and performance.
- Replacement engines should be the same model as the original engine, or be the Briggs & Stratton designated replacement engine. Refer to the Operation & Maintenance Instructions for engine identification information.
Note: For all Go-karts use only a model 136200 series engine, which offers improved safety and performance.
- Do not use Briggs & Stratton engines on 3-wheel All-Terrain Vehicles (ATVs), motor bikes, air craft products, or vehicles intended for use in competitive events. Briggs & Stratton does not approve of or authorize such uses.

ENGINE INSTALLATION



- [1] Do not attempt to install this engine if you do not have the appropriate tools and knowledge of small engine installation procedures. Use only Briggs & Stratton parts. Contact your Authorized Service Dealer for assistance.
- [2] Do not modify the engine in any way without Briggs & Stratton factory approval. Any such modification is at the owner's sole risk.
- [3] If the exhaust system on the old engine was supplied by the equipment manufacturer, you must transfer the exhaust system and related components (original muffler and related pipes, brackets, clamps, and shields) to the new engine. All components must be in good condition.
- [4]



 WARNING	Install muffler (and muffler deflector if used) so outlet points away from operator, fuel tank, and equipment, and so muffler heat will not damage or deform engine and components.
	
- [5]



 WARNING	Ensure all fuel lines and fittings are properly assembled and do not leak. Replacement parts must be the same model as the original.
	
- [6]



 WARNING	Ensure all wiring, including safety switches and engine shut-off components are completely installed and functioning properly.
	
- [7] Set engine speed to equipment manufacturer's specification. Refer to equipment manufacturer's manual. Do not tamper with governor springs, or other parts that will increase engine speed above specification.

- [8]







 WARNING	All engine parts, including fuel cap, spark plug, muffler, air cleaner, and covers and guards for drive components (gears, belts, shafts, couplings, etc.) must be in place before attempting to start engine.
	
- [9]

 WARNING	If engine is installed on walk behind lawn mower, all mower components, including cutting blade, must be correctly installed before attempting to start engine.
	
- [10]

 WARNING	When working on the engine or equipment, remove spark plug wire from spark plug. For electric start, remove negative wire from battery.
	
- [11]

 WARNING	Do not check for spark with spark plug removed. Use Briggs & Stratton spark tester #19368.
	

ENGINE OPERATION

	 WARNING
	When adding fuel:
<p>Turn engine off and let engine cool at least 2 minutes before removing gas cap.</p> <p>Fill fuel tank outdoors or in well-ventilated area. Fill tank to about 1 inch below lowest portion of neck to allow for fuel expansion.</p> <p>Keep gasoline away from sparks, open flames, pilot lights, heat, and other ignition sources.</p>	
	 WARNING
	When starting engine:
<p>Remove all external equipment/engine loads.</p> <p>Wait until spilled fuel is evaporated. Start engine outdoors.</p> <p>Pull cord slowly until resistance is felt, then pull rapidly.</p> <p>If engine floods, set choke to OPEN/RUN, place throttle in FAST and crank until engine starts.</p>	
	 WARNING
	When operating equipment:
<p>Do not tip engine or equipment at angle which causes gasoline to spill.</p> <p>Run engine outdoors. Do not run in enclosed area, even if doors or windows are open.</p> <p>Do not choke carburetor to stop engine.</p>	

Starting and Operating the Model "Y" Motor

	Paragraph		Paragraph
Before Starting the Motor.....	1	How to Stop.....	4
How to Start.....	2	General Data.....	5
Failure of Motor to Start.....	3		

1. **BEFORE STARTING THE MOTOR.** Fill the crankcase with Mobiloil Arctic or any other high grade oil not heavier than S. A. E. No. 20. A HEAVIER OIL MUST NOT BE USED. The oil filler plug is painted blue and is located directly below breather tube. With the motor level remove filler plug and pour oil in opening until it rises to the level of the filler plug opening. Crankcase holds one pint. Fill the gas tank with a good grade of clean regular gasoline. Tank holds one quart. Do not mix oil and gasoline. See paragraphs 11 to 19.

2. **HOW TO START.** Pull up the carburetor choke knob. Step down quickly on starter pedal to prime the motor. After motor has been primed, open choke about half way and, when motor starts, gradually open the choke valve until it runs smoothly with the choke valve wide open. (A warm motor does not require as much choking as a cold motor.) See paragraph 20.

3. **FAILURE OF MOTOR TO START.** If motor fails to start after a reasonable number of trials do not make any adjustments until you have studied the instructions referred to in the Servicing Reference Chart on page 3.

4. **HOW TO STOP.** Pull the choke knob all the way out and hold until motor stops firing.

5. **GENERAL DATA.** You will find your Briggs & Stratton motor substantially built. It is made of high grade materials by skilled workmen, in a factory fully equipped with the most modern machinery. Before it was shipped, it received many tests and careful inspections.

6. Your motor will give you better service if you do not tinker with it. This does not mean, however, that it does not require a certain amount of attention. Give it the right kind of fuel, oil and care. Keep it clean both inside and out. You will be well repaid in trouble-free, satisfactory service.

7. If you should experience any difficulty, follow the instructions referred to in the Servicing Reference Chart on page 3. If you cannot easily remedy it, consult your dealer, or a nearby Briggs & Stratton Authorized Central Service Distributor. See page 15.

Briggs & Stratton 4-Cycle Motor, Model "Y" — Plate No. 1

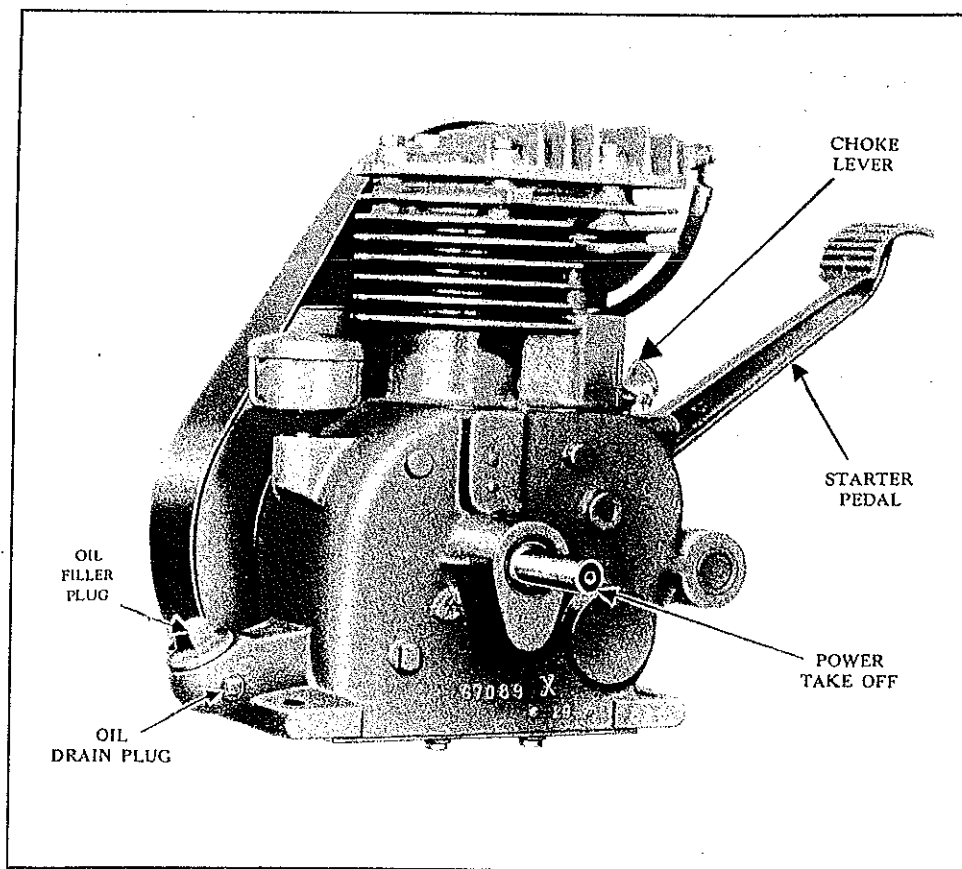

Servicing Reference Chart

MOTOR FAILS TO START

	Paragraph
Out of Gasoline.....	1-16
Out of Oil.....	1-13-56
Dirt or Gum in Fuel System.....	16 to 19
Correct Use of Choke.....	20
Carburetor Out of Adjustment.....	22 to 25
Spark Plug Dirty.....	29-30
Ignition Cable Grounded.....	31
Magneto.....	34-43
Poor Compression.....	44-53

MOTOR STOPS

Out of Gasoline.....	1-16
Out of Oil.....	1-13-56
Dirt or Gum in Fuel System.....	16 to 19
Motor Overheated.....	13-56-57-59
Motor Overloaded.....	59

MOTOR OVERHEATS

	Paragraph
Out of Oil.....	1-13-56
Oil Needs Changing.....	14-15
Oil Too Heavy.....	12
Carburetor Out of Adjustment.....	22 to 25
Poor Spark.....	28-43
Carbon.....	57
Muffler Clogged.....	58
Overloaded.....	59

MOTOR LACKS POWER

Lack of Oil.....	1-13-56
Add or Change Oil.....	13 to 15
Carburetor Out of Adjustment.....	22 to 25
Motor Not Up to Speed.....	24-27
Poor Spark.....	43
Poor Compression.....	53
Carbon.....	57
Muffler Clogged.....	58
Overloaded.....	59

Instructions for Adjustment and Repair

	Paragraph		Paragraph
Operating Requirements.....	8	To Remove and Replace Magneto Assembly.....	34
How a 4-Cycle Motor Operates.....	10	Magneto Timing.....	35
Keep the Motor Clean.....	11	To Adjust and Clean Contact Points.....	36
Use the Right Kind of Oil.....	12	To Replace Condenser.....	38
Add Oil Regularly.....	13	To Replace Armature.....	40
Change Oil Frequently.....	14	Cylinder Head.....	44
Use Clean Gasoline.....	16	Compression.....	45
Avoid Gummy Gasoline.....	17	Valve Adjustment.....	46
To Clean the Fuel Lines.....	19	Piston.....	51
Correct Use of the Choke.....	20	Piston Rings.....	53
To Prime the Motor.....	21	Piston Pin.....	54
To Adjust the Carburetor.....	22	Connecting Rod.....	55
To Remove and Replace Carburetor.....	24	Oil Leaks.....	56
To Remove and Replace Carburetor Throttle Governor—Correct Motor Speed.....	25	Carbon.....	57
The Ignition System.....	26	Muffler.....	58
To Check for Spark.....	28	Overload.....	59
Spark Plug Adjustment.....	29	Exhaust Tubing.....	60
Ignition Cable.....	30	Starter Pedal Assembly.....	61
To Remove and Replace Flywheel.....	31	Starter Clutch.....	62
	32	Parts.....	64

8. **OPERATING REQUIREMENTS.** A gasoline motor to operate properly must have all parts in correct adjustment to provide good ignition, carburetion, compression and cooling. And of equal importance, the oil and gasoline used must be clean and of recommended grades. The following instructions fully explain the simple adjustments and offer operating recommendations that will assure

you of complete satisfaction. We urge you to carefully observe them.

9. The reliability, economy and ease of starting which characterize this motor are due in part to the fact that it is of the 4-stroke cycle design commonly called "4-cycle," the same design used in all automotive motors. As the name indicates there are four strokes to one complete power cycle.

10. HOW A 4-CYCLE MOTOR OPERATES. On the intake stroke the piston goes down, producing a vacuum in the cylinder, thereby drawing fuel up through the carburetor so that the space above the piston becomes filled with combustible gas. During this stroke the intake valve is open. Next the piston comes up on the **compression stroke** with both valves closed. At the top of the compression stroke a spark occurs at the spark plug, firing the highly compressed gas. This produces an explosion above the piston which forces it down on the **power stroke**. Both valves are closed. On the next upstroke of the piston, called the **exhaust stroke**, the exhaust valve is open, and the burned gases driven out. See plate No. 2.

The 4-Stroke Cycle
Plate No. 2

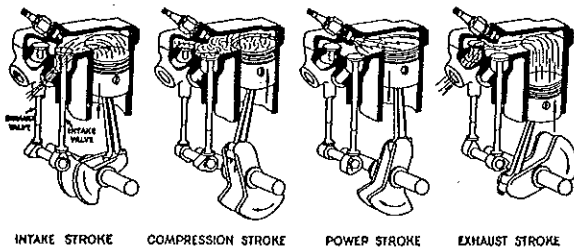

11. KEEP THE MOTOR CLEAN. It will pay you to keep your motor clean both inside and outside. See that no dirt or water enters motor when filling with oil or gasoline. As a precautionary measure always wipe off the gasoline cap and oil filler plug, as well as around them before refilling. Dirt in the motor or gasoline tank will cause trouble and even serious damage.

12. USE THE RIGHT KIND OF OIL. Correct lubrication is important. We recommend the use of MOBIL OIL "ARCTIC" or other high grade oil with similar characteristics having a low carbon residue and a body not heavier than S. A. E. No. 20. **A heavier oil which might be satisfactory in a tractor or for lubricating farm machinery must NOT be used.** Do not mix oil with the gasoline. This 4-cycle motor is provided with an independent efficient splash lubrication system which feeds oil to all moving parts of the motor. There are no external parts which require separate oiling.

13. ADD OIL REGULARLY. A motor which is run without oil will be ruined within a few minutes. To avoid the possibility of such an occurrence and the resulting expense, always fill the oil reservoir at the blue plug to the top of the filler plug opening after each five hours of motor operation. Capacity of oil reservoir is one pint.

14. CHANGE OIL FREQUENTLY. After every twenty-five hours of motor operation, the oil should be completely drained from the crankcase. Do not remove motor from its mounting base. Remove the yellow oil drain plug, located in oil filler boss, and let the oil flow into a pan or other receptacle you use. We do not recommend flushing out with kerosene. Replace the drain plug, refill with fresh oil and replace blue filler plug.

15. In the normal running of any motor, small particles of metal from the cylinder walls, pistons and bearings will gradually work into the oil. Dust particles from the air also get into the oil. If the oil is not changed regularly, these foreign particles cause increased friction and a grinding action which shortens the life of the motor. Sludge, a gummy mass, forms which clogs up the oil passages. Fresh oil also assists in cooling, for old oil gradually becomes thick and loses its cooling as well as its lubricating qualities.

16. USE CLEAN GASOLINE. A good clean, fresh third grade gasoline is recommended. Too high test gasoline may form vapor-lock in gas line when motor gets hot. This interrupts the flow of gasoline and causes motor to stop. Be sure that the small vent hole in the gasoline tank cap is not clogged up, for air must enter the tank to allow the gasoline to flow to the carburetor. Test by blowing through top of cap.

17. AVOID GUMMY GASOLINE. If you experience trouble with a gummy, sticky substance with a peculiar sharp obnoxious smell, change to another grade of gasoline. This gum comes from the gasoline and clogs carburetor, gas line, gasoline tank, etc. You can check your gasoline by evaporating a half pint in an open dish. If a quantity of gum remains, try another kind that is clean and fresh.

18. You can avoid most trouble from gum if you will keep the tank full when you are not using the motor. If you use it only occasionally, drain tank completely and refill when motor is used again. The reason for this is that evaporation of stale gasoline causes most gum deposits.

19. TO CLEAN THE FUEL LINES. Disconnect the gasoline line at the carburetor and also at the gas tank. Blow through the gas line to clear. Remove the gas tank feed pipe which is screwed into the gas tank proper. At its base you will find a screen which may be clogged. To determine whether this pipe itself is clear, blow through the pipe from the screen end. There is a check ball in the base of this pipe which must be free. See plate No. 3. Check ball must close air passage when blowing through opposite end of pipe. When replacing gas pipe in tank, be sure to place gasket between gas tank and gas pipe nut. **IMPORTANT:** If you find a gummy varnish-like substance, alcohol or acetone will dissolve it. See paragraphs 17 and 18.

Gas Pipe
Plate No. 3

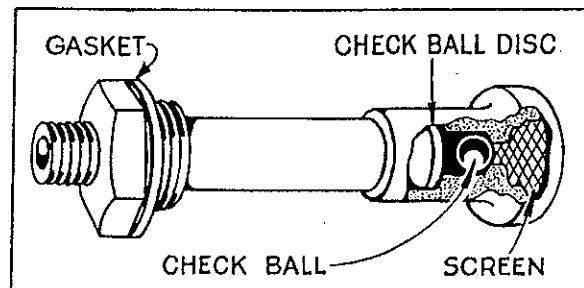

20. CORRECT USE OF THE CHOKE. The correct carburetor setting (see paragraph 23) gives the motor the best mixture to run on when it is hot. For starting, it is necessary to choke the carburetor to get a rich mixture, because cold gasoline does not vaporize readily. A warm or hot motor requires very little choking. Until you become familiar with your motor, however, you may make the mistake of not choking the carburetor enough or you may choke it too much. If motor fails to start after cranking three or four times with the choke closed, try cranking two or three times with the choke part-way down and then all the way down, or open. Use motor choke the same as you use an automobile choke.

21. TO PRIME THE MOTOR. The motor may fail to start for the reason that either the carburetor is incorrectly adjusted or dirty, or the fuel line is dirty or clogged, or you are out of gasoline. To determine the cause, prime the motor by removing the spark plug and pour a half teaspoonful of gasoline into the spark plug opening. Replace the spark plug and crank the motor. If it fires

for three or four revolutions and stops, the difficulty is definitely in the fuel system. See paragraphs 19, 22 to 25. If motor will not fire at all, check the ignition system, see paragraphs 28 to 43, also compression, paragraphs 44 to 53.

22. TO ADJUST THE CARBURETOR. The carburetor on the Model "Y" motor is of the suction type. The gasoline supply is regulated by a needle valve. The throttle is automatically controlled by the governor.

23. To adjust the carburetor, completely close needle valve by turning to right or clockwise as far as possible. Do not screw up too tight or use force when closing needle valve, or needle valve may be damaged. From closed position, open needle valve one to one and one-quarter turns. After the motor has been started and warmed up make final adjustment with the choke wide open by turning the needle valve to the point at which motor operates most smoothly with full load. This setting will also take care of starting with use of the choke. When starting cold motor, if it is necessary to keep choke partially closed several minutes before motor runs smoothly, carburetor setting is too lean and needle valve should be opened a notch or two—turn to left. For governor adjustments see paragraphs 26 and 27.

Carburetor and Governor Hook-Up
Plate No. 4

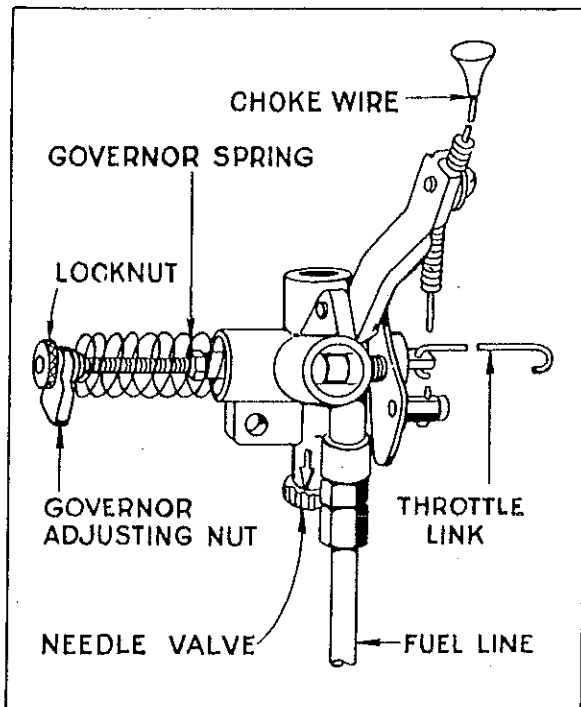

24. TO REMOVE AND REPLACE CARBURETOR. Disconnect gasoline line from carburetor. Remove choke wire and casing from bracket and choke lever. Remove two carburetor mounting screws and lockwashers. Loosen carburetor from intake pipe by working from side to side. With carburetor loose, turn it to the right and at the same time push throttle out far enough to permit the throttle link to slip out. To replace, reverse the operation as performed above. Be sure the open ends of throttle link are toward the crankcase. See plate No. 4.

25. TO REMOVE AND REPLACE CARBURETOR THROTTLE. To clean carburetor throttle, remove carburetor as explained in the previous paragraph. To remove throttle, note the position of adjusting nut, then remove locknut, adjusting nut and throttle

spring. Loosen throttle stud locknut and remove stud from throttle. The throttle can then be removed. Do not scrape throttle. Remove gas line connector and needle valve. Clean all parts in alcohol or acetone. Blow through all passages and openings. Do not use wire to clean out small holes. To reassemble, reverse the operations and screw adjusting nut to its former position. Be sure locknuts are tight.

26. GOVERNOR—CORRECT MOTOR SPEED. The speed of your model "Y" motor is automatically maintained under varying loads by a pneumatic governor. It is operated by the air current blown by the flywheel.

27. The governor was carefully adjusted at the factory to maintain normal speed under load. To increase the motor speed, screw in the adjusting nut on the carburetor. See plate No. 4. Recommended speed is from 1700 to 1900 R. P. M. On washing machine application, adjust motor speed to operate washing machine agitator at speed recommended by the manufacturer of your washer.

28. THE IGNITION SYSTEM. The spark is produced by a high tension magneto consisting of armature, condenser, contact points and rotating magnets cast in the flywheel. This is a simple self-contained system which is very reliable. It also does away with batteries. The ignition current is sent into the motor cylinder through the ignition cable and spark plug. The magneto itself as well as the cable and spark plug must all be in proper condition and adjustment to insure a good hot spark.

29. TO CHECK FOR SPARK. To prove that a satisfactory spark is being delivered by the magneto, remove the ignition cable from the plug. Hold ignition cable terminal about $\frac{1}{8}$ " from any metal part of the cylinder head (keep hand on insulated part of the cable to avoid a shock). Turn motor with starter, and if the spark jumps this gap the entire ignition system, with the exception of the spark plug, is O. K. See plate No. 5. If no spark, check cable, see paragraph 31, and refer to magneto adjustments paragraphs 32 to 43.

30. SPARK PLUG ADJUSTMENT. Spark plugs should be cleaned occasionally and points reset to .025". Points burn away in service. The porcelain is to prevent the spark from jumping anywhere except at the gap, and if cracked or broken it will prevent the plug firing. Water on the outside of the spark plug may permit the high voltage current to leak over the surface of the porcelain. Dirt or carbon on it will do the same thing. The spark plug can be cleaned by taking the plug apart and washing off the carbon with gasoline or kitchen scouring powder. Points should be scraped or sand-papered. See plate No. 6. Always keep a new plug on hand. We recommend the use of Champion No. 6M or its exact equivalent.

Checking Spark
Plate No. 5

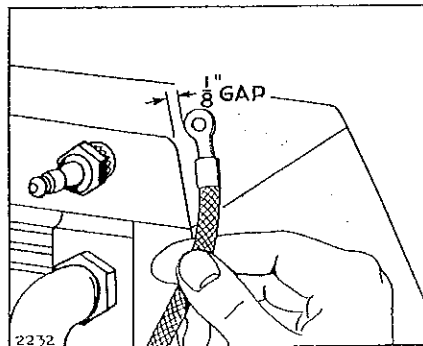

Spark Plug
Plate No. 6

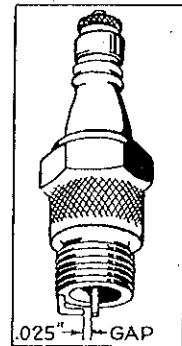

31. **IGNITION CABLE.** Insulation must not be broken, or soaked with oil or water, or grounded in any way where it touches the motor, or it will interfere with good ignition. Spark plug cable should be soldered to the secondary terminal (small brass plate coming out of the coil). Avoid touching coil with hot soldering iron. See plate No. 11.

32. **TO REMOVE AND REPLACE FLYWHEEL.** The flywheel is mounted to the crankshaft with a bolt and nut. Remove the starter pedal and blower housing. Loosen flywheel nut and bolt enough so that you can remove starter clutch assembly. Mark flywheel and crankshaft on the bolt head side. Remove nut and bolt. The flywheel will then come off by tapping on the end of the crankshaft with a hammer and pulling on the flywheel. Protect the end of the crankshaft with a wooden block. A special tool No. 29593 is designed to remove flywheel easily and is available from the factory at 35c net each.

33. To reassemble, locate marks you have made on flywheel and crankshaft, line up holes in flywheel with that in crankshaft and assemble bolt and one clutch retainer clip, with the bolt head on the marked side of the flywheel. Replace starter clutch, then bolt securely in place.

Removing Flywheel
Plate No. 7

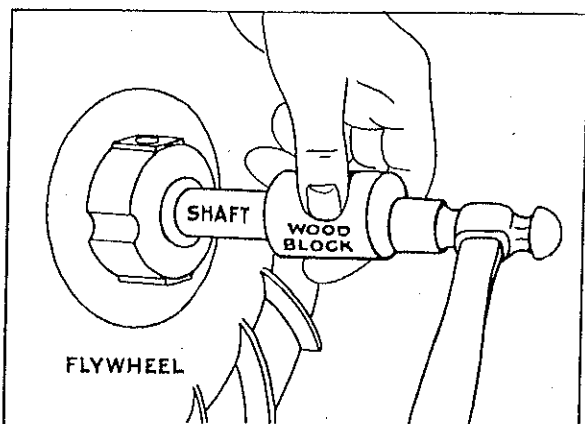

34. **TO REMOVE AND REPLACE MAGNETO ASSEMBLY.** After removing flywheel as explained in paragraph 32, detach the ignition cable from the spark plug and remove the four magneto mounting screws. Turn the crankshaft so that the contact plunger holds the contact points open and then remove magneto assembly. To replace reverse the operations and use the old gasket between the plate and crankcase, or, if damaged, a new gasket. See part

Correct End Play
Plate No. 8

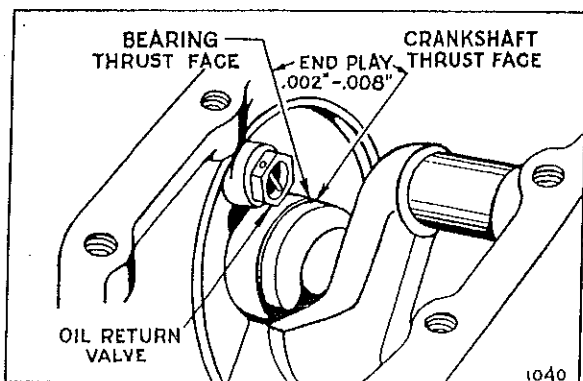

66457, 66527, 66537 for proper thickness to get correct end play of .002" to .008" between magneto bearing and crankshaft thrust faces, as shown in plate No. 8. Use lockwashers under mounting screws.

35. **MAGNETO TIMING.** The magneto assembly is always correctly timed with the motor when the flywheel is assembled to the crankshaft and securely held in place with a bolt and nut. Do not attempt to change the timing by relocating any parts or filing crankshaft timing flat.

36. **TO ADJUST AND CLEAN CONTACT POINTS.** While magneto plate is on motor crankcase, turn crankshaft by hand to see if contact points open and close properly. Points must be clean and line up squarely to make good electrical contact. Do not file contact points—use fine sandpaper or fine grit hone to clean points.

Magneto Contact Points
Plate No. 9

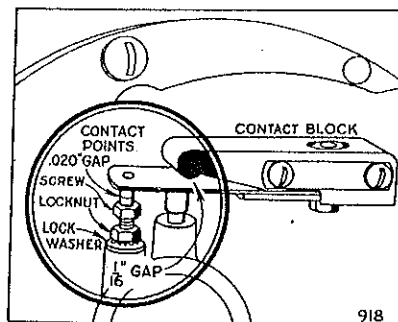

37. To line up contact points loosen contact spring bolt. Move contact spring assembly to line up with contact screw point. Tighten contact spring bolt. To adjust contact spring tension place $\frac{1}{8}$ " gauge between contact spring and round end of contact block, then tighten contact block screws. Turn contact screw to secure .020" gap and tighten locknut against lockwasher. See plate No. 9. If either or both points become badly pitted or burned, replace both points, part Nos. 63238 and 69754.

38. **TO REPLACE CONDENSER.** A leaky or weak condenser may cause the motor to start hard, to sputter, or misfire under load. If motor misfires after checking gasoline line, carburetor, spark plug, cable and contact points, install a new condenser. Slip the short insulator sleeve over the condenser wire. Solder the end of condenser wire and primary wire to contact spring. (See plate No. 10.)

Condenser Installation
Plate No. 10

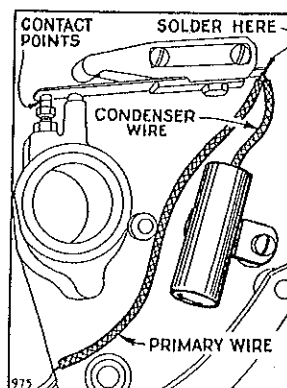

39. If after new condenser has been installed the ignition system still does not deliver a satisfactory spark, we recommend

sending the complete magneto unit including the flywheel to the nearest Briggs & Stratton Central Service Distributor listed on page 15 for proper adjustment.

40. TO REPLACE ARMATURE. Remove armature lead wire from contact spring, and high tension ignition cable from secondary terminal loop in the armature. Both wires are soldered. Save as much of the hydrolene as possible so that you can insulate high tension terminal when you assemble new armature. Do not use battery compound or tar as it will melt and run over the entire magneto assembly. Unscrew two armature mounting screws and pry armature loose with screw driver.

Complete Magneto Assembly
Plate No. 11

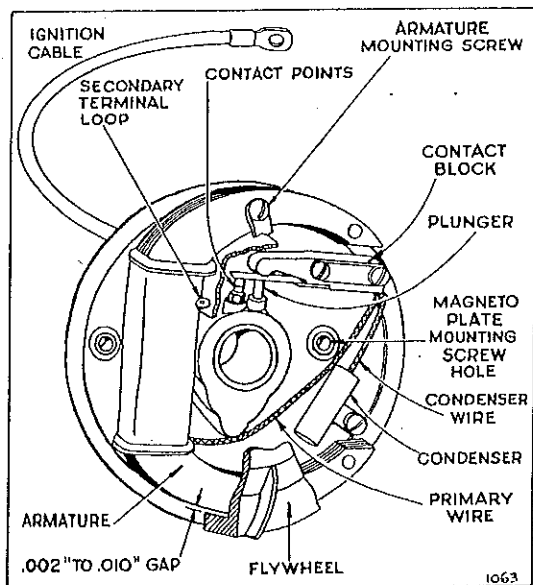

41. To install armature, locate it on the magneto plate and fasten armature to plate with two screws. Then solder ignition cable to the terminal and fill pocket, formed with flap, with hydrolene. Solder armature lead wire to contact spring. See plate No. 11.

42. Air gap of .002" to .010" must be maintained between armature shoes and flywheel poles. Gap must only be sufficient to prevent rubbing but not over .010" or poor ignition will result.

43. To check armature shoes for rub, chalk edges and mount flywheel in place. Remove spark plug to release compression. Turn flywheel several revolutions by hand. Remove flywheel and examine edges of armature shoes. High spot will have the chalk rubbed off. File high spots carefully with a fine file until flywheel no longer rubs, but do not remove too much metal.

44. CYLINDER HEAD. The cylinder head is held on with six cap screws. When the cylinder head has been removed for the purpose of cleaning carbon or grinding valves, care should be used in replacing it. Use a new gasket if possible. Otherwise, clean the old one and coat both sides with cup grease. We do not recommend the use of shellac on cylinder head gaskets. Tighten each cap screw a little at a time so that the cylinder head is pulled down evenly. Screws need be only moderately tight.

45. COMPRESSION. Proper compression is obtained when valves seat properly, gaskets do not leak, and piston and rings are properly fitted. When tuning up a motor, it is always well to check compression. This is done by turning the motor over quickly by hand. If turned slowly sticky valves may not be detected. If a point of resistance is offered every other revolution, compression

should be satisfactory. If motor turns over without compression resistance for a full cycle, it is possible that a worn piston or piston rings, leaky valves or leaky gaskets are present. See that spark plug has a gasket under it and is drawn up tight. Also check cylinder head gasket and tighten cylinder head bolts.

46. VALVE ADJUSTMENT. To check valve clearance remove valve cover plate on cylinder below carburetor. The correct clearance on the exhaust valve is .020" and on the intake valve .010" when the motor is cold. Tappet clearance is adjusted by grinding required amount from the end of valve stem. End of stem must be square with the stem proper.

47. To remove valves, remove cylinder head, and if not dismantled, drain oil from crankcase. Invert cylinder. Compress the spring with valve spring compressor No. 69189-T3, and with the end of a screw driver push out the split collars, and release valve spring compressor. Tilt cylinder back far enough to allow valve to drop, permitting its stem to clear the spring. Pry spring out with end of screw driver.

48. To replace valves and valve springs, compress spring in valve spring compressor. Turn tool to inverted position with collar retainer washer on top. Drop split collar in place in retainer washer one at a time. When first half of split collar is placed in retainer washer, push it around to the back of valve stem to allow easy placing of second half. Special valve spring compressor tool part No. 69189-T3 is available at the factory at \$1.25 net.

49. To reset valves, grind in the same manner as automobile valves. If valves stick they may be coated with gum or carbon. To remove gum use alcohol or acetone. Clean valve stems thoroughly with wire brush or emery cloth. Also scrape all carbon from valve ports.

Valve Timing — Plate No. 12

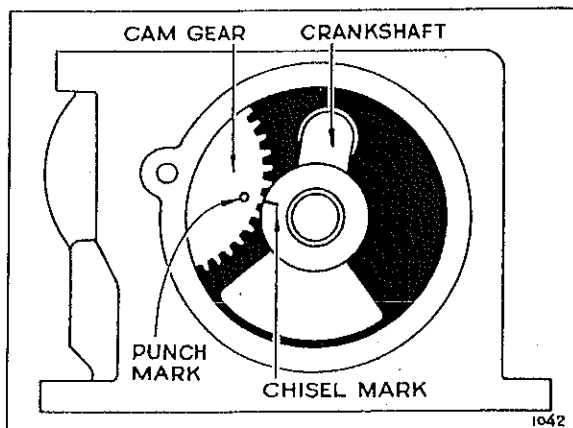

50. The timing of the valves is taken care of by the meshing of the cam shaft gear with the gear on the crankshaft. These gears are properly meshed when the mark on the cam shaft gear is in line with the mark on the crankshaft collar. See plate No. 12.

51. PISTON. The piston in this motor is made of a special aluminum alloy which is very light in weight. The standard clearance between the piston skirt and cylinder wall is .0055" to .007". This clearance is to compensate for the considerable expansion of aluminum when hot. The top and second lands of the piston are smaller than the skirt to allow for greater expansion at the piston head. When piston is removed be sure to thoroughly clean carbon from head of piston and ring grooves. If piston is out of round or scored it should be replaced.

52. When fitting a new piston in the motor, assemble it with the free side pin hole with an "X" on boss, toward the magneto side. If an over-size piston is necessary, we recommend that re-

boring of cylinder be done by an Authorized Central Service Distributor or the factory.

53. PISTON RINGS. The piston rings when fitted in the cylinder should have a gap of .007" to .017". The rings should be fitted in the cylinder below the piston ring travel. Before assembling new rings to piston be sure that piston ring grooves are thoroughly cleaned and rings move in grooves freely.

54. PISTON PIN. The piston pin is a free fit in one side of the piston and a tight fit in the other. To remove this pin without special equipment, it is advisable to heat the piston in boiling water which causes the aluminum alloy to expand. Cut a wooden pin a little smaller than the size of the piston pin and use this and a hammer to drive the pin out. Drive the pin out through the free fit hole. This hole is toward the magneto side and is indicated with an "X" on the pin hole boss. You should, of course, drive the pin out while the piston is still hot. To easily replace the pin the piston should be heated.

55. CONNECTING ROD. The connecting rod is also made of a special aluminum alloy which combines strength with light weight. When assembling connecting rod to crankshaft, the bevel flat must be toward the cam gear. See plate No. 13. The assembly marks on cap and rod must be on the same side.

Connecting Rod — Plate No. 13

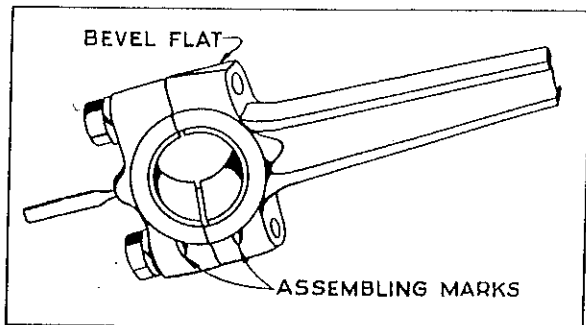

56. OIL LEAKS. If oil leaks from either end of crankshaft bearings, remove base from motor. Oil return valves are screwed into crankcase and magneto back plate, below main bearings. Remove oil return valve and clean or flush with gasoline and blow out any dirt lodged under the small disc. Replace if necessary. See plate No. 8.

57. CARBON. Excessive carbon is caused by improper grade of oil—too much oil usually the result of piston rings not seating properly or sticking—carburetor set too rich—or long service. An unusual amount of carbon is noticeable by motor knocking or loss of power. Occasionally remove carbon from valves, valve ports, piston head, piston rings and ring grooves, cylinder head and top of cylinder bore.

58. MUFFLER. After long periods of service it is possible that the muffler will become clogged to the point where it will affect the motor's power. To check the muffler unscrew it from the motor and run water into the open end of the muffler. If full streams of water come out of the small holes at the end of the muffler, you will know that it is not clogged up. If the water

runs through very slowly, however, the muffler is probably clogged and should be replaced.

59. OVERLOAD. Always be sure that the machine the motor is operating is well lubricated and running freely. If it is not, it may cause the motor to become overloaded resulting in it overheating, losing power, or even stopping entirely.

60. EXHAUST TUBING. A certain amount of water forms inside of the exhaust tube, after it cools off, due to condensation. After motor is stopped, place exhaust tube so that water from condensation cannot drain into exhaust port of motor to corrode the mechanical parts and eventually result in trouble. If exhaust pipe is too long, or clogged, back pressure will reduce motor power.

61. STARTER PEDAL ASSEMBLY. The gear sector on the starter pedal of this type motor should align squarely with the starter pinion on the crankshaft. Use the three washers on the pedal shaft by changing them to different positions between starter shaft lugs until gear sector lines up with the center of starter pinion gear. Be sure that the sector does not bind in any position. To replace the sector it is necessary to remove only two rivets and rivet new one in place. See plate No. 14.

Plate No. 14

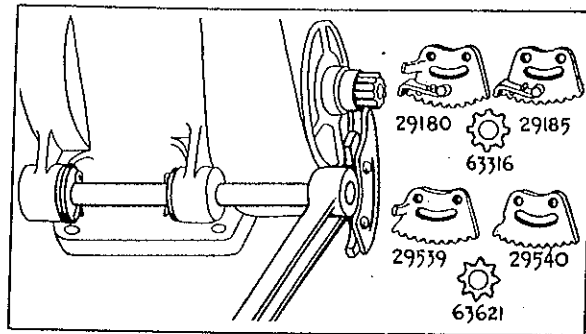

62. STARTER CLUTCH. The pinion gear No. 63316 of the starter clutch assembly, on the first model "Y" motors had blunt gear teeth. This pinion gear was used with sector assembly Nos. 29180 and 29185 which are equipped with a spring tooth assembly as shown in plate No. 15. Do not use this pinion gear with new type sector assemblies 29539 and 29540 which are not equipped with a spring tooth.

63. The new starter clutch pinion gear No. 63621 has pointed teeth and it can be used with all of the sector assemblies shown in plate No. 14. To assemble starter clutch refer to plate No. 15.

Plate No. 15

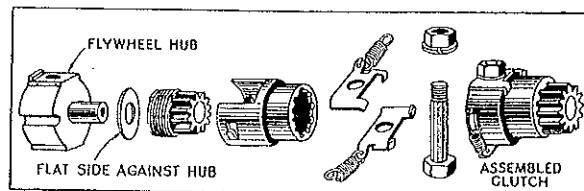

64. PARTS. All parts should be ordered from your dealer or the nearest Briggs & Stratton Service Distributor, listed on page 15.

Repair Parts

	Paragraph	Page
Always Give Type, Model and Serial Number	66	
How to Make Out Parts Orders	68	10-13
Prices	72	14
Parts List		10-13
Parts Illustrations		14

65. To assure continued satisfactory performance, do not attempt to use substitute repair parts when overhauling or repairing the Briggs & Stratton Motor. Insist that all repair parts be original Briggs & Stratton parts.

66. **ALWAYS GIVE TYPE, MODEL AND SERIAL NUMBERS.** Briggs & Stratton motors are identified by a type number, model letter and a serial number. This information is stamped on a metal plate attached to the blower housing.

67. When writing to the factory or to a Central Service Distributor for service information, or when ordering new parts, be sure to specify the type number, the model, and the serial number of the unit to be serviced. This will assure prompt and efficient service without unnecessary correspondence.

68. **HOW TO MAKE OUT PARTS ORDERS.** Print your name and address plainly and correctly. Do not abbreviate name of town or state. Specify on the order how shipment to you is to be made. This will assist in giving prompt and efficient service.

69. Give part number and name of parts wanted. (Do not use number cast on parts.) You will find the part numbers, names and prices on pages 11 to 13, and parts illustrations on page 14.

70. After you have made out order, check back to see that you have followed all instructions and have accurately listed what you want.

71. Shipments will be made C. O. D. or send remittance with order to cover parts and add what you think will be sufficient for postage. Send postal or express money order, bank draft or certified check for this amount. Do not send currency in a letter. It is not safe.

72. **PRICES.** All prices in this book are subject to change without notice. In case of change in prices, orders will be filled at current prices. All prices shown are F. O. B. Factory at Milwaukee, Wis., or nearest Authorized Central Service Distributor. Prices outside U. S. A. subject to local import duties, taxes, etc.

THE GUARANTEE—For One Year from purchase date, Briggs & Stratton Corporation will replace for the original purchaser, FREE OF CHARGE, any part or parts found, upon examination at our factory at Milwaukee, Wisconsin, or at any Authorized Central Service Distributor's place of business, to be defective under normal use and service, on account of defects in material or workmanship.

All transportation charges on part, or parts, submitted for replacement under this guarantee must be borne by purchaser.

WHAT THIS GUARANTEE DOES NOT INCLUDE—This guaranty does not cover the free replacement of parts inoperative because of wear occasioned by use. It does not cover the labor cost of replacing parts, neither is it effective if the motor has been the subject of misuse, negligence or accident, nor if it has been repaired or altered outside of our Milwaukee Factory or any Authorized Central Service Distributor in any way which, in our judgment, affects its condition or operation.

TO FIND THE CORRECT NUMBER OF THE PART YOU NEED

1. Make a note of your motor TYPE NUMBER (not the Serial Number) that appears on the metal nameplate attached to motor blower housing.
 2. Refer to pages illustrating parts and locate the Master Part Number by comparing your old part with the illustrations. Assemblies include all part numbers bracketed in illustrations. All parts shown in assembly brackets on which part numbers are given can be purchased separately.
 3. After the Master Part Number has been identified, refer to the following Parts Lists where these Master Part Numbers are listed in numerical order.
The Master Part is used on all types of motors except those types listed under "Note."
 4. If a "Note" appears below the Master Part Number, this means that this part is made different from the Master Part for certain types and if your type is listed under "Note," order the part referred to.
- If two or more parts are bracketed () under "Note," they are used to replace the Master Part on the type numbers shown.
5. If your Motor Type Number does not appear after any part number listed under "Note," order the Master Part Number.
 6. When ordering parts or writing for service information — always specify the MODEL LETTER — TYPE NUMBER — and SERIAL NUMBER of your motor.

MODEL "Y" PARTS LIST

MASTER PART NUMBER	NAME	MASTER PART NUMBER	NAME
22353	Washer — Valve Cover	46133	Spring — Spark Plug Shield
22368	Washer — Control Lever	46277	Rivet — Tubular — 1/8" x 3/16"
22372	Clamp — Control Wire Casing	61010	Ring — Piston, Compression — Top and Center — .010" O.S.
	NOTE: No. 62022 Clamp — Control Wire Casing Used on type Nos. 60100, 60176, 60281, 60309, 60333, 60340, 60460, 60461, 60884.	61012	Ring — Piston, Compression — Top and Center — .020" O.S.
	No. 62393 Clamp — Control Wire Casing	61013	Ring — Piston, Compression — Top and Center — .030" O.S.
	No. 91239 Screw — Sheet Metal — No. 10 x 3/4" Parker-Kalon.	61222	Head — Cylinder
	Used on type Nos. 60389, 60761, 60784, 60819.		NOTE: No. 67831 Head — Cylinder Used on type Nos. 60857, 60873.
22725	Washer — Control Lever	61284	Nut — Throttle Adjusting
22834	Washer — Spacer	61311	Gear — Cam
22944	Lock — Connecting Rod Screw	61415	Pulley — Rope Starter
	NOTE: No. 90832 Lockwasher — 1/4 x 3/32 x 5/64" Used on connecting rods with dipper cast on cap.		NOTE: No. 61743 Pulley — Rope Starter Used on type No. 60857. No. 69962 Pulley — Rope Starter Used on type No. 60149.
23402	Locknut — Contact Screw	61418	Support — Engine Mounting
23571	Swivel — Control Lever	61435	Pulley — Drive, Flat Belt — 2 1/16" Dia.
23580	Bushing — Control Lever	61505	Ring — Piston, Oil — Sid.
26035	Spring — Stop Pin	61747	Ring — Piston, Oil — .010" O.S.
27090	Gasket — Spark Plug	61748	Ring — Piston, Oil — .020" O.S.
29131	Shield — Spark Plug	61749	Ring — Piston, Oil — .030" O.S.
29133	Tooth — Sector Spring (Not Available; Order Part No. 291162)	62007	Clamp — Fuel Tank
29180	Sector — Starter Pedal (Replaced by No. 29539)		NOTE: No. 62199 Washer No. 91339 Screw — Machine, Rd. Hd. 1/4-20 x 1/2" Used to mount fuel tank on type Nos. 60389, 60819.
29185	Sector — Starter Pedal (Replaced by No. 29540)	62021	Strap — Fuel Tank
29236	Tube Assembly — Control Casing	62100	Stop — Contact Spring
	NOTE: No. 29642 Tube Assembly — Control Casing Used on type No. 60784.	62142	Ring — Oil Retainer
29346	Cable — Ignition		NOTE: No. 62157 Ring — Oil Retainer For type numbers see "Note" under Master Part No. 69818.
	NOTE: No. 29552 Cable — Ignition Used on type No. 60857.	62143	Ring — Oil Retainer
29539	Sector — Starter Pedal	62148	Cup — Starter Clutch Spring
29540	Sector — Starter Pedal	62151	Retainer — Cup and Spring
29593	Puller — Flywheel	62152	Washer — Starter Clutch Spring
	NOTE: Optional accessory	62154	Cover — Valve
29656	Armature	62170	Vane — Governor Air
29861	Condenser	62176	Plate — Engine Base
29863	Outlet Assembly — Fuel Tank	62178	Plate — Contact Block
29865	Tank Assembly — Fuel	62180	Bracket — Choke Wire Casing
	NOTE: No. 29870 Tank Assembly — Fuel Used on type Nos. 60389, 60784, 60819. No. 69417 Tank Assembly — Fuel Used on type No. 60173.		NOTE: No. 62582 Guide — Choke Wire Used on type Nos. 60857, 60873.
35817	Bumper — Starter Pedal		
38882	Washer — Bumper Mounting		
42007	Washer — Starter Shaft		

MASTER PART NUMBER	NAME
62187	Retainer — Cup and Spring
62208	Spacer — Pulley Mounting NOTE: Use three No. 62208 spacers for pulley on type Nos. 60281, 60649. No. 63594 Spacer — Pulley Mounting Used on type No. 60178.
62213	Guard — Starter Pinion NOTE: No. 62468 Guard — Starter Pinion Used on type No. 60857.
62266	Washer — Blower Housing Bracket
62304	Switch — Stop NOTE: No. 62384 Switch — Stop Used on type Nos. 60389, 60761, 60784, 60819, 60835, 60842.
62454	Bar — Spacer
63058	Connector — Fuel Pipe
63092	Spacer — Engine Mounting NOTE: No. 63160 Spacer — Engine Mounting Used on type No. 60100. No. 63289 Spacer — Engine Mounting Used on type No. 60173.
63136	Pin — Needle Valve Stop
63238	Screw — Contact Point
63321	Pipe — Carburetor Intake
63327	Pin — Governor Vane Pivot
63361	Screw — Pulley Mounting NOTE: No. 63444 Screw — Pulley Mounting Used on type Nos. 60110, 60161, 60240, 60518, 60603. No. 63593 Screw — Pulley Mounting Used on type No. 60178.
63423	Spacer — Cylinder Head
63621	Pinion — Starter Clutch
63673	Bushing — Starter Lug
65078	Block — Contact Spring
65158	Bumper — Starter Pedal
65294	Washer — Fuel Tank Outlet
65414	Plunger — Magneto Point
65451	Ring — Piston, Compression Top and Center — Sid.
65506	Casing — Choke Wire — 35 1/4" long NOTE: If longer casing is needed, specify length in inches; if shorter casing is needed, order No. 65506 and cut to required length.
65522	Bracket — Blower Housing
65534	Gasket — Oil Filler Cap
65617	Gasket — Valve Cover
65687	Gasket — Base Plate
65725	Insulator — Armature Lead
65735	Insulator — Condenser Lead
65787	Washer — Fuel Pipe Connector
65906	Spring — Exhaust and Intake Valve
66246	Lock — Piston Pin
66432	Washer — Choke Wire Casing
66457	Gasket — Magneto Plate — .015"
66527	Gasket — Magneto Plate — .005"
66537	Gasket — Magneto Plate — .009"
66646	Wire — Control 37 3/4" long NOTE: If longer wire is needed, specify length in inches; if shorter wire is needed, order No. 66646 and cut to required length.
66656	Casing — Control Wire — 35 3/8" long NOTE: If longer wire is needed, specify length in inches; if shorter casing is needed, order No. 66656 and cut to required length.
66916	Tappet — Exhaust and Intake Valve
66979	Rope — Starter
67083	Valve — Needle

MASTER PART NUMBER	NAME
67236	Crankshaft NOTE: No. 26019 Crankshaft Used on type Nos. 60807, 60846. No. 67486 Crankshaft Used on type Nos. 60083, 60110, 60113, 60127, 60140, 60161, 60162, 60176, 60178, 60199, 60240, 60281, 60399, 60427, 60444, 60499, 60518, 60529, 60553, 60603, 60649, 60865.
67249	Cleaner — Air
67376	Spring — Starter Clutch Return
67426	Link — Carburetor Throttle
67456	Spring — Starter Return NOTE: No. 67586 Spring — Starter Return Used on type Nos. 60146, 60148, 60177, 60184, 60189, 60281, 60310, 60333, 60461, 60489, 60512, 60567, 60588, 60649, 60662, 60728, 60807, 60865, 60884.
67466	Spring — Carburetor Throttle. NOTE: No. 67746 Spring — Carburetor Throttle Used on type No. 60169.
67506	Spring with Washer — Starter Clutch
67766	Clip — Air Cleaner
68022	Bracket — Blower Housing
68122	Plug — Cam Shaft
68283	Collar — Valve Spring
68293	Washer — Valve Spring Retainer
68333	Shaft — Cam Gear
68449	Muffler NOTE: No. 89567 Muffler Muffler does not include flexible tubing — furnished by equipment manufacturer. Used on type No. 60175.
68652	Wrench — Spark Plug
68743	Throttle — Carburetor NOTE: No. 63757 Throttle — Carburetor Used on type Nos. 60857, 60873.
68923	Valve — Intake and Exhaust. NOTE: No. 23662 Valve — Exhaust Used on type Nos. 60857, 60873.
69004	Gasket — Cylinder Head
69221	Cap — Fuel Tank NOTE: No. 29860 Cap — Fuel Tank Used on type No. 60857.
69245	Pulley — Drive, "V" Belt (3" diam., 1" hub) NOTE: No. 29282 Pulley — Drive, "V" Belt (3" dia. 3/4" hub) Used on type No. 60460 No. 29293 Pulley — Drive, "V" Belt 2 5/16" dia., 1" hub, with spacer between pulley halves. Used on type Nos. 60189, 60190, 60738. No. 63137 Pulley — Drive, "V" Belt 2 3/16" dia., 1" hub. Used on type Nos. 60098, 60100, 60106, 60111, 60129, 60310, 60339, 60616, 60728, 60761, 60812, 60842. No. 64269 Pulley — Drive, "V" Belt 3 3/8" dia., 1" hub. Used on type Nos. 60146, 60535, 60807. No. 69368 Pulley — Drive, "V" Belt 3" dia., 1 1/2" hub. Used on type No. 60461.
69326	Pipe — Fuel — 22" long NOTE: For other lengths, specify: No. 29285 Pipe — Fuel — 15" No. 29291 Pipe — Fuel — 11" No. 29411 Pipe — Fuel — 13" No. 29510 Pipe — Fuel — 7" No. 29544 Pipe — Fuel — 27" No. 64179 Pipe — Fuel — 8" No. 64409 Pipe — Fuel — 23" No. 64419 Pipe — Fuel — 9" (See following page)

Before ordering parts, read instructions top page 10.

MASTER PART NUMBER	NAME
	No. 64499 Pipe — Fuel — 12"
	No. 69324 Pipe — Fuel — 6"
	No. 69335 Pipe — Fuel — 19"
	No. 69339 Pipe — Fuel — 14"
	No. 69374 Pipe — Fuel — 26 1/8"
	No. 69404 Pipe — Fuel — 16"
	No. 69451 Pipe — Fuel — 7 1/2"
	No. 69502 Pipe — Fuel — 9 1/2"
	No. 69700 Pipe — Fuel — 24"
	No. 69827 Pipe — Fuel — 10 1/2"
	No. 69987 Pipe — Fuel — 14 1/2"
	No. 99099 Pipe — Fuel — 5"
69462	Wire — Choke 37 1/4" long NOTE: If longer wire is needed, specify length in inches; if shorter wire is needed, order No. 69462 and cut to required length.
69751	Breather
69752	Cylinder NOTE: No. 69814 Cylinder Used on type Nos. 60083, 60113, 60127, 60140, 60161, 60162, 60176, 60178, 60199, 60240, 60281, 60399, 60427, 60444, 60499, 60529, 60553, 60603, 60649, 60865.
69754	Spring and Point — Contact
69755	Housing — Blower NOTE: No. 29139 Housing — Blower Used on type Nos. 60149, 60310, 60333, 60461, 60662, 60884. No. 29167 Housing Blower Used on type Nos. 60177, 60588. No. 29182 Housing — Blower Used on type No. 60807. No. 29219 Housing — Blower Used on type Nos. 60146, 60148, 60489, 60567, 60649. No. 29342 Housing — Blower Used on type Nos. 60184, 60728. No. 29521 Housing — Blower. Used on type Nos. 60784, 60857. No. 29626 Housing — Blower Used on type No. 60512. No. 64469 Housing — Blower Used on type No. 60189.
69756	Rod Assembly — Connecting
69780	Block Assembly — Contact
69781	Magneto Assembly NOTE: No. 69993 Magneto Assembly (Ground Wire) Used on type Nos. 60111, 60129, 60175, 60657, 60748. Includes: { No. 65335 Wire — Ground { No. 65634 Bushing — Rubber No. 290850 Magneto Assembly (Shielded Ignition Cable) Used on type No. 60857.
69782	Plate — Back
69792	Carburetor Assembly NOTE: No. 29702 Carburetor Assembly Used on type Nos. 60389, 60626, 60761, 60784, 60819, 60835, 60842, 60857, 60873. No. 64199 Carburetor Assembly Used on type No. 60169.
69804	Body — Carburetor NOTE: No. 29735 Body — Carburetor Used on type Nos. 60389, 60626, 60761, 60784, 60819, 60835, 60842, 60857, 60873.
69818	Bushing — Cylinder Includes: No. 62142 Ring — Oil Retainer NOTE: No. 69825 Bushing — Cylinder Includes: No. 62157 Ring — Oil Retainer Used on type Nos. 60083, 60113, 60127, 60140, 60161, 60162, 60176, 60178, 60199, 60240, 60281, 60399, 60427, 60444, 60499, 60529, 60553, 60603, 60649, 60865.

MASTER PART NUMBER	NAME
69819	Bushing — Magneto Plate Includes: No. 62143 Ring — Oil Retainer
69821	Plate — Magneto
69848	Pulley — Drive — "V" Belt — 3" dia. NOTE: No. 64109 Pulley Half 3 3/4" dia. Used on type Nos. 60110, 60161, 60178. No. 69832 Pulley — Drive — "V" Belt — 2 9/16" dia. Used on type Nos. 60529, 60807.
69852	Starter Assembly — Foot NOTE: No. 29063 Starter Assembly — Foot Used on type No. 60199. No. 29088 Starter Assembly — Foot Used on type No. 60333. No. 29148 Starter Assembly — Foot Used on type No. 60535. No. 29166 Starter Assembly — Foot Used on type Nos. 60177, 60588. No. 29181 Starter Assembly — Foot Used on type Nos. 60360, 60512. No. 29192 Starter Assembly — Foot Used on type No. 60489. No. 29206 Starter Assembly — Foot Used on type No. 60377. No. 29214 Starter Assembly — Foot Used on type No. 60310. No. 29283 Starter Assembly — Foot Used on type No. 60460. No. 29287 Starter Assembly — Foot Used on type No. 60461. No. 29329 Starter Assembly — Foot Used on type No. 60109. No. 29359 Starter Assembly — Foot Used on type Nos. 60662, 60807. No. 29517 Starter Assembly — Foot Used on type No. 60593. No. 29534 Starter Assembly — Foot Used on type Nos. 60215, 60427. No. 29541 Starter Assembly — Foot Used on type Nos. 60567, 60649, 60884. No. 29562 Starter Assembly — Foot Used on type No. 60686. No. 29660 Starter Assembly — Foot Used on type No. 60808. No. 64169 Starter Assembly — Foot Used on type No. 60176. No. 64249 Starter Assembly — Foot Used on type No. 60113. No. 64259 Starter Assembly — Foot Used on type No. 60161. No. 64389 Starter Assembly — Foot Used on type Nos. 60184, 60728, 60865. No. 64759 Starter Assembly — Foot (Not Available) Used on type No. 60189. No. 69816 Starter Assembly — Foot Used on type Nos. 60083, 60100, 60111, 60127, 60190, 60738, 60885. No. 69869 Starter Assembly — Hand Used on type Nos. 60125, 60210, 60228, 60389, 60518, 60616, 60626, 60657, 60717, 60726, 60761, 60819, 60835. No. 69946 Starter Assembly — Foot Used on type Nos. 60309, 60737. No. 69957 Starter Assembly — Foot Used on type Nos. 60146, 60148. No. 69981 Starter Assembly — Foot Used on type No. 60098. No. 69990 Starter Assembly — Foot Used on type Nos. 60162, 60163. No. 69991 Starter Assembly — Foot Used on type Nos. 60110, 60178, 60281, 60340, 60511.

Before ordering parts, read instructions top page 10.

MASTER PART NUMBER	NAME
69902	Clutch Assembly — Starter
71163	Locknut — Carburetor Throttle
89307	Valve — Oil Return
90202	Screw — Machine, Fill. Hd. 10-32 x 1/2"
90355	Nut — Hex. 10-32
90367	Lockwasher — No. 8 x 5/64 x 1/32"
90576	Nut — Hex. 8-32
90597	Screw — Machine, Rd. Hd. — 10-32 x 1/2"
90832	Lockwasher — 1/4 x 3/32 x 5/64"
90891	Screw — Cap, Hex. Hd. — 1/4-20 x 1/2"
90895	Screw — Cap, Hex. Hd. — 3/8-16 x 1"
90916	Screw — Machine, Rd. Hd. — 1/4-20 x 1/2"
91084	Plug — Pipe — 3/8"
	NOTE: No. 90878 Plug — Pipe — 1/4" Used on type Nos. 60148, 60857.
91122	Lockwasher — Shakeproof No. 1206
91162	Screw — Cylinder Head
	NOTE: No. 67253 Spacer — Cylinder Head Screw No. 91387 Screw — Cylinder Head Used in place of one No. 91162 Screw on type No. 60109. No. 67243 Spacer — Cylinder Head Screw (1) No. 68863 Spacer — Cylinder Head Screw (3) No. 68873 Spacer — Cylinder Head Screw (2) No. 91110 Screw — Cylinder Head (3) No. 91203 Screw — Cylinder Head (1) No. 91386 Screw — Cylinder Head (2) Used to mount cylinder head on type Nos. 60857, 60873.
91210	Screw — Set Socket Hd., Cup Pt. — 3/8-16 x 5/8"
91219	Elbow — Exhaust
	NOTE: No. 91245 Nipple — Exhaust Used with No. 91219 elbow on type No. 60512. { No. 91245 Nipple — Exhaust { No. 91246 Elbow — Exhaust Used on type No. 60333. No. 91447 Nipple — Exhaust Used on type Nos. 60083, 60127, 60885. No. 91464 Elbow — Exhaust Used on type Nos. 60140, 60173, 60215, 60389, 60784, 60819, 60857.
91223	Screw — Set, Sq. Hd. — 3/8-16 x 1/2"
	NOTE: No. 91231 Screw — Set, Socket Hd. — 3/8-16 x 3/8" Used on type Nos. 60460, 60461, 60885.
91237	Lockwasher — 1/4 x 3/32 x 5/64"
91242	Locknut — Muffler Elbow
91253	Screw — Machine, Fill. Hd. — 6-32 x 5/16"
91270	Screw — Machine, Rd. Hd. — 1/4-20 x 1"
91363	Screw — Set, Sq. Hd. — 3/8-16 x 3/8"
	NOTE: No. 91223 Screw — Set, Sq. Hd. — 3/8-16 x 1/2" Used on type No. 60149. No. 91696 Screw — Set, Socket Hd. — 3/8-16 x 3/8" Used on type No. 60857.

MASTER PART NUMBER	NAME
91366	Screw — Machine, Rd. Hd. — 10-32 x 3/8"
91370	Bolt — Flywheel Mounting
	NOTE: No. 91681 Bolt — Flywheel Mounting — 1/32" O.S.
91385	Screw — Magneto Mounting
91388	Lockwasher — 5/16 x 3/32 x 3/32"
91389	Screw — Cap, Hex. Hd. — 1/4-20 x 1 1/4"
91402	Locknut — Carburetor Throttle
91408	Eyelet — Carburetor Throttle
91409	Stud — Carburetor Screw
91413	Pin — Cotter, 1/8 x 1" long
91442	Screw — Cap, Hex. Hd. — 5/16-18 x 2 1/4"
91450	Screw — Clutch Guard
91494	Screw — Machine, Fill. Hd. — 10-32 x 3/8"
	NOTE: No. 90964 Screw — Machine, Fill. Hd. — 10-32 x 3/4" Used to mount air cleaner clip on type Nos. 60169, 60389, 60616, 60761, 60784, 60812, 60819, 60857.
91560	Bolt and Nut — Stove, Rd. Hd. — 3/16 x 1 1/4"
91725	Coupling — Oil Drain Pipe
92129	Nut — Hex. — 1/4-28
92146	Screw — Connecting Rod
	NOTE: No. 92296 Screw — Connecting Rod Used on connecting rods with dipper cast on cap.
92268	Lockwasher — 3/8 x 1/8 x 3/32"
92285	Pin — Colter, No. 18 x 1/4"
92287	Screw — Machine, Rd. Hd. — 10-32 x 1/4"
92290	Lockwasher — No. 10 x 1/16 x 3/64"
92305	Washer — Control Lever (1/16" Thick)
92306	Screw — Cap, Hex. Hd. — 1/4-28 x 3/8"
92308	Screw — Machine, Fill. Hd. — 10-32 x 1/4"
92609	Screw — Connecting Rod Dipper
	NOTE: No. 92296 Screw — Connecting Rod Used on connecting rods with dipper cast on cap.
99920	Piston Assembly — Standard
99967	Piston Assembly — .010" O.S.
99968	Piston Assembly — .020" O.S.
99969	Piston Assembly — .030" O.S.
290413	Cap — Oil Filler
290415	Flywheel Assembly
290568	Lever Assembly — Control (Stamped Steel)
290584	Base — Control Lever (Stamped Steel)
290642	Lever — Control (Stamped Steel)
290654	Screw and Nut Assembly — Contact Block
290918	Lever Assembly — Control (Cast Iron)
290984	Plug — Spark (with Gasket)
290985	Pin Assembly — Piston — Std.
290986	Pin Assembly — Piston — .005 O.S.
291197	Nut and Washer — Flywheel Bolt

Before ordering parts, read instructions top page 10.



