

# Briggs & Stratton OPERATING AND MAINTENANCE INSTRUCTIONS

## MODELS 19D, 19D-FB, 19D-R6

**IMPORTANT:** Do not start this engine before reading Section I and Section II of this manual.

### CAUTION

**PROVIDE EFFICIENT VENTILATION.** Exhaust gases contain carbon monoxide, an odorless and deadly poison. Do not operate engine in an enclosed area.

**KEEP ENGINE CLEAN.** This engine is air-cooled. If cooling system becomes clogged, serious damage may result. Therefore, keep the blower screen, fins on flywheel, cylinder head and block free from grass or dirt.

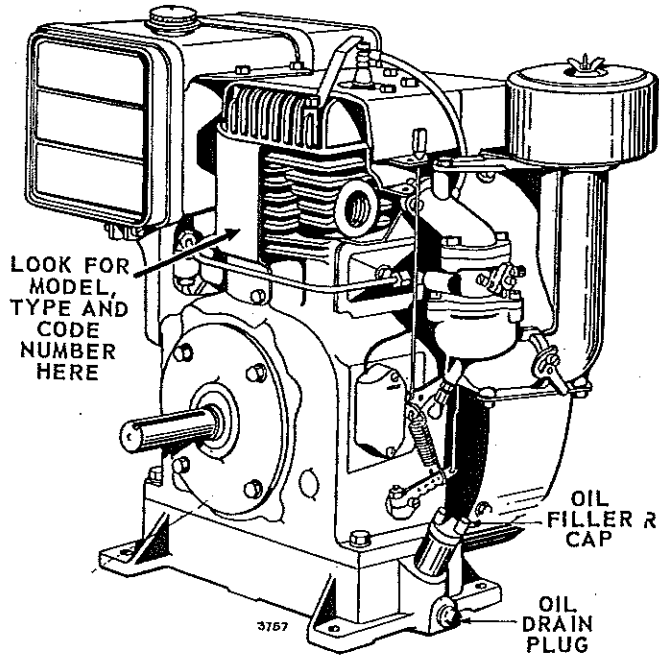

## SECTION I BEFORE STARTING

### "OIL-FOAM"® AIR CLEANER

"Oil-Foam"® air cleaners are oiled at the factory and do not require initial service.

### FILL FUEL TANK

Use clean, fresh "regular" grade gasoline. Fill tank completely.

**DO NOT FILL GASOLINE TANK WHILE ENGINE IS RUNNING.** Avoid spilling gasoline on a hot engine — this may cause an explosion and serious injury.

**DO NOT MIX OIL WITH GASOLINE**

### OIL RECOMMENDATIONS

**WINTER**  
(Below 40° F.)  
Use SAE 5W-20  
If not Available  
Use SAE 10W  
Above 10° F.

**SUMMER**  
(Above 40° F.)  
Use SAE 30  
If not Available  
Use SAE 10W-30

Nothing should be added to the recommended oils.

### FILL CRANKCASE WITH OIL

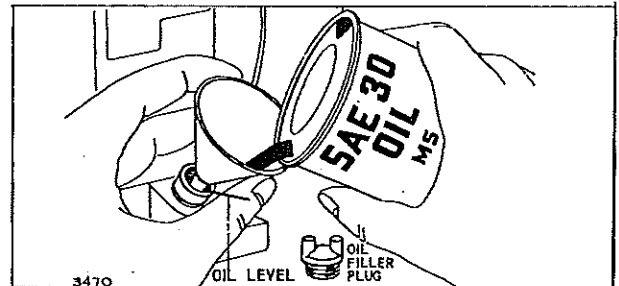

Remove the oil filler plug. Place the engine level. Fill the crankcase to overflowing. **POUR SLOWLY.** CAPACITY 3 PINTS. Replace the filler plug.

Any high quality detergent oil having the American Petroleum Institute classification "For Service MS" can be used in your Briggs & Stratton engine. Detergent oils keep the engine cleaner and retard the formation of gum and varnish deposits.



## SECTION II STARTING

### TO START ENGINE

#### 1. Open Fuel Valve

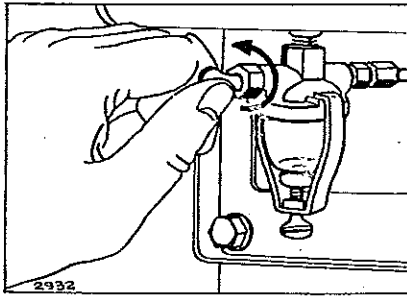

#### 2. Close the Choke

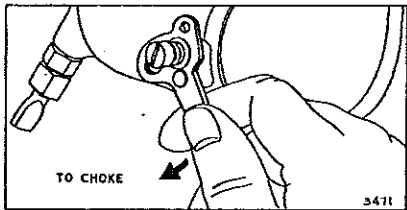

#### 3. Start Engine

##### a. Rope Starter

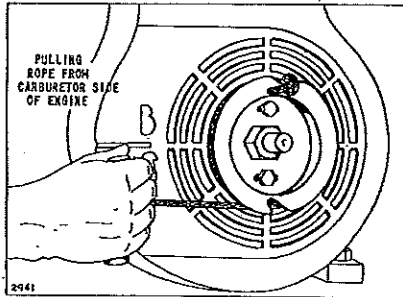

Place knot in pulley notch and wind rope around pulley in a clockwise direction. Pull rope with choke closed to prime the engine. Open choke slightly and repeat operation.

After engine warms up open choke gradually until engine runs smoothly with choke wide open (counter-clockwise position).

##### b. 12 Volt D.C. Electric Starter

Press starter button on powered equipment. When engine starts, open choke gradually.

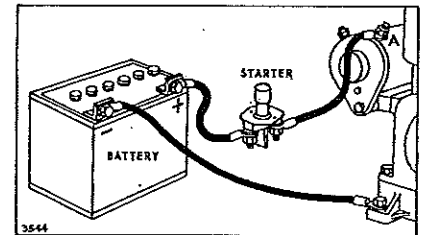

## STOPPING

### To Stop Engine

Push the stop switch against end of spark plug.

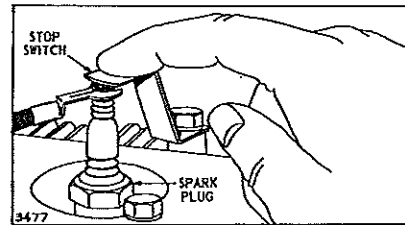

## SECTION III REGULAR MAINTENANCE

### CHANGE OIL (Crankcase)

Change oil after 5 hours of operation. Remove the oil drain plug. Drain oil while engine is warm. Replace drain plug. Remove oil filler cap or plug and refill with new oil. Replace oil filler cap or plug. Add oil regularly after each 5 hours of operation. Thereafter change oil every 25 hours of operation.

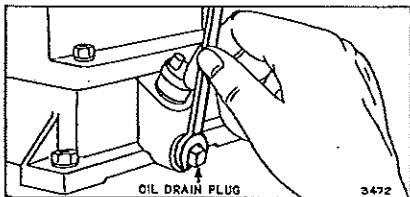

### CHANGE OIL (Gear Reduction)

The reduction gears are lubricated by engine crankcase oil. Remove drain plug from gear case cover to drain oil remaining in gear case when crankcase oil is changed.

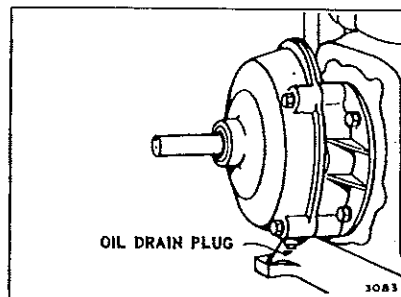

### TO CHECK SPARK PLUG GAP

Clean spark plug and reset gap at .025" every 100 hours of operation. When worn out replace with AC GC 46, Autolite A71 or Champion J-8. Size 14 mm.

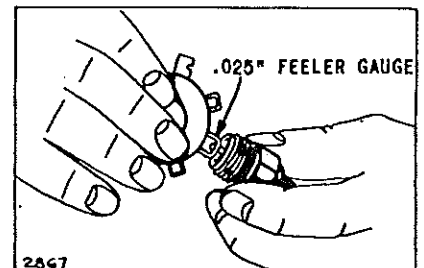

**SERVICING "OIL-FOAM"® AIR CLEANER**

Clean and re-oil the air cleaner frequently (every few hours under extremely dusty conditions). Clean and re-oil at least every 25 hours under normal conditions.

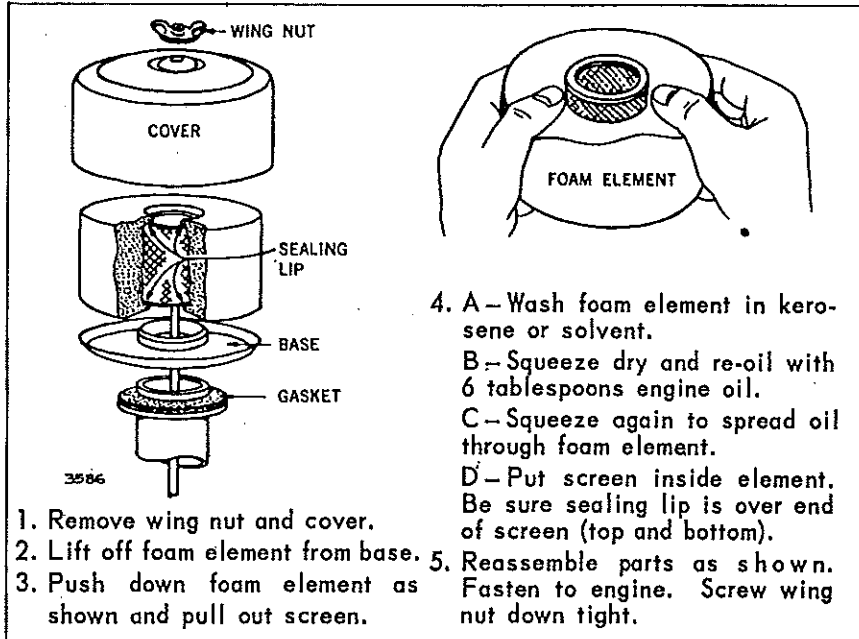

1. Remove wing nut and cover.
2. Lift off foam element from base.
3. Push down foam element as shown and pull out screen.

4. A - Wash foam element in kerosene or solvent.  
 B - Squeeze dry and re-oil with 6 tablespoons engine oil.  
 C - Squeeze again to spread oil through foam element.  
 D - Put screen inside element. Be sure sealing lip is over end of screen (top and bottom).
5. Reassemble parts as shown. Fasten to engine. Screw wing nut down tight.

**DRAINING FUEL TANK AND CLEANING FUEL FILTER**

Loosen thumb screw below filter bowl.

Remove and clean filter bowl and screen.

Open shut-off valve to see if fuel flows freely from the tank. **IMPORTANT:** If you find a gummy, varnish-like substance use alcohol or acetone to dissolve it.

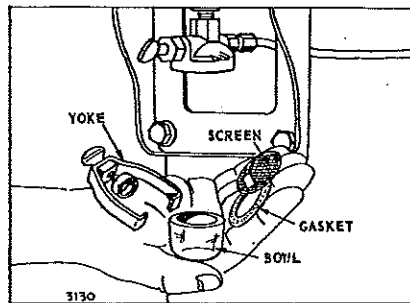

**CLEAN COOLING SYSTEM**

Grass or chaff may clog cooling system after prolonged service in cutting tall dry grasses or hay. Continued operation with a clogged cooling system causes severe overheating and possible engine dam-

age. Remove blower housing and clean regularly.

**TO CLEAN AND ADJUST CONTACT POINTS**

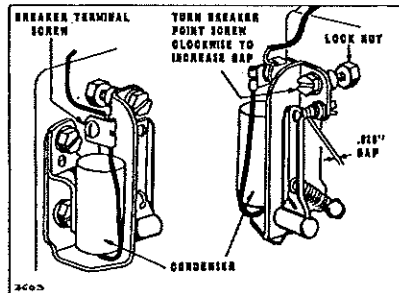

Remove cover.

Clean points with a carborundum contact point stone. Then insert a hard finished card or piece of paper and close and open points. The paper will absorb any dirt or filings on the points. Adjust breaker points as follows:

- a. Rotate crankshaft until points open to widest gap.
- b. Loosen lock nut illustrated above until it is just snug.

c. Rotate breaker point screw to obtain .020" gap.

d. When gap is .020" tighten lock-nut.

e. Replace breaker box cover.

**CLEAN COMBUSTION CHAMBER EVERY 100-300 HOURS OF OPERATION**

This industrial engine generally operates at constant speed and at relatively constant load. The use of regular automotive fuels under these conditions results in a gradual build-up of tetra-ethyl lead deposits in the combustion chamber.

This causes the engine to lose power and prevents the valves from seating properly. Removing the deposits is easy and will pay big dividends in reliability and increased valve life.

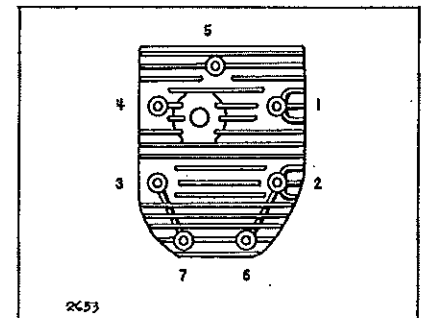

1. Remove cylinder head screws. Be sure to note if screws are of different length and have steel washers as they must be replaced in original position.

2. Turn crankshaft until piston is at top of cylinder bore and both valves are closed. Scrape and wire brush the lead and carbon deposits from cylinder head and combustion chamber.

3. Re-use cylinder head gasket only if in good condition. Replace cylinder head. Turn each screw in with wrench until screw head is lightly seated.

4. Use socket wrench with 6 inch handle and turn all screws 1/4 turn. Tighten screws in sequence illustrated. Run engine approximately 5 minutes and re-tighten all screws approximately 1/4 turn.

## SECTION IV ADJUSTMENTS

### CARBURETOR ADJUSTMENTS

#### Initial Adjustment

Turn needle valve clockwise until it just closes: **CAUTION:** Valve may be damaged by turning it in too far.

Now open needle valve 1-1/2 turns counterclockwise.

Close idle valve in same manner and open it 1/2 to 3/4 turns. This initial adjustment will permit the engine to be started and warmed up prior to final adjustment.

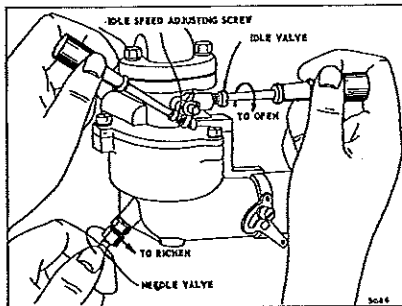

#### Final Adjustment

Turn needle valve in until engine misses (lean mixture), then turn it out past smooth operating point until engine runs unevenly (rich mixture). Now turn needle valve to the mid-point between rich and lean so the engine runs smoothly.

Hold throttle at idle position, set idle speed adjusting screw until fast idle is obtained (1200 RPM). Hold throttle in idle position and turn idle valve in (lean) and out (rich) until engine idles smoothly. Then reset idle speed so that engine idles at 1200 RPM. Release throttle—engine should accelerate without hesitation or sputtering. If engine does not accelerate properly, re-adjust carburetor to a slightly richer mixture.

### GOVERNOR ADJUSTMENTS

The correct operating speed range is 1800 to 3600 RPM. The standard speed setting (no load) is 2900 RPM. Idle speed is 1200 RPM.

#### Thumb Nut Adjustment

To increase speed, turn nut (clockwise) or move lower end of governor or spring farther away from governor lever shaft.

To reduce speed, turn nut counterclockwise) or move lower end of spring closer to governor lever shaft.

If the speed of the engine is not steady although the carburetor has been properly adjusted, move the spring farther away from the governor lever shaft.

If the speed variation between no load and full load is too great, move spring closer to governor lever shaft.

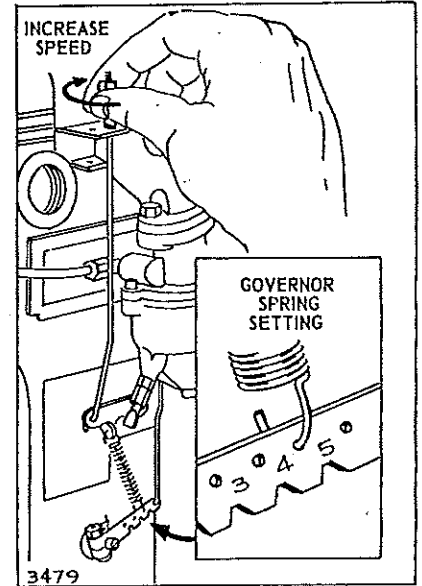

### REMOTE GOVERNOR CONTROL

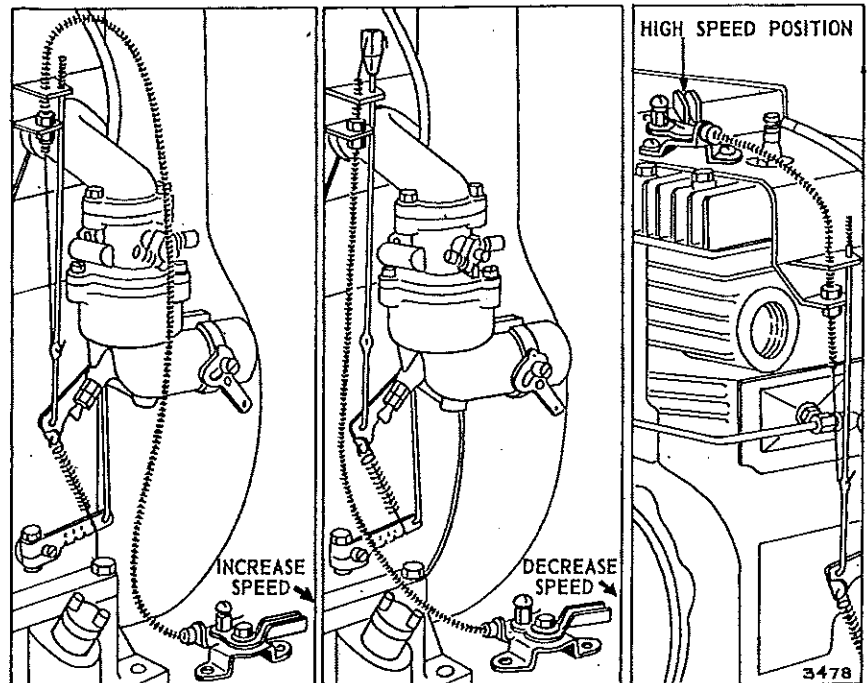

Engine speed is controlled by movement of the control lever. To adjust: Move control lever to HIGH speed position. Loosen screw on swivel. Move wire through swivel until desired operating speed is obtained. Retighten swivel screw, bend loose end of wire around swivel. Cut off excess wire. Be sure to remove or loosen thumb screw on governor control rod.

**SECTION V**  
**GENERAL INFORMATION**

**These engines are single cylinder, L-Head, air-cooled type**

**Bore - 3"; Stroke - 25/8"; Displacement - 18.56 cu. in.; Horsepower: -**

3.65 h.p. at 1800 r.p.m.	5.45 h.p. at 2400 r.p.m.
6.70 h.p. at 3000 r.p.m.	7.25 h.p. at 3600 r.p.m.

Torque (Ft.-Lbs.) . . . . .	11.95 at 2400 RPM
Intake Valve Clearance . . . . .	.007" - .009"
Exhaust Valve Clearance . . . . .	.017" - .019"

The horsepower ratings listed above are established by standard I.C.E.I. procedures. For practical operation, the horsepower loading should not exceed 85% of these ratings. Engine power will decrease 3½% for each 1,000 ft. above sea level and 1% for each 10 degrees above 60 degrees F.

Major engine repairs should not be attempted unless you have the proper tools and a thorough knowledge of internal combustion engines.

**STORAGE INSTRUCTIONS**

Engines stored for over 30 days should be completely drained of fuel to prevent gum deposits forming on essential carburetor parts, fuel filter, fuel lines and tank.

- a. Remove filter bowl, open shut-off valve and drain tank completely.
- b. Replace filter bowl. Leave fuel valve open.
- c. Operate engine until it stops from lack of fuel.
- d. While engine is still warm, drain and clean the oil sump. Refill with fresh oil.
- e. Remove spark plug, pour one ounce of SAE 30 oil into cylinder and crank slowly to spread oil. Replace spark plug.
- f. Clean dirt and chaff from cylinder, cylinder head fins and blower housing.

Briggs & Stratton's policy of continual product improvement is evidenced by the many patents issued to the corporation covering engine improvements, some of which are listed below.

2,431,329	2,510,825	2,564,787	2,693,789	2,717,916	2,954,506	3,040,853
2,438,585	2,529,242	2,573,116	2,693,791	2,781,280	2,999,489	3,044,238
2,459,428	2,529,243	2,605,753	2,696,577	2,796,453	2,999,491	3,044,239
2,491,070	2,529,244	2,649,488	2,699,636	2,796,454	2,999,562	3,114,851
2,496,688	2,548,334	2,669,322	2,717,589	2,908,263	3,028,848	3,118,433

DESIGN PATENTS

173,072	191,806
---------	---------

SECTION VI  
WARRANTY

SAVE THIS INFORMATION FOR YOUR OWN RECORD

**BRIGGS & STRATTON ENGINE WARRANTY**

For ONE YEAR from purchase date, Briggs & Stratton Corp. will replace for the original purchaser, FREE OF CHARGE, any part, or parts, found upon examination by any Factory Authorized Service Outlet, or by the Factory at Milwaukee, Wisconsin, to be DEFECTIVE IN MATERIAL AND/OR WORKMANSHIP.

All transportation charges on parts submitted for replacement under this Warranty must be borne by purchaser.

*There is no other Warranty express or implied. Briggs & Stratton Corp. shall in no event be liable for consequential damages.*

BRIGGS & STRATTON CORP.

  
C. L. COUGHLIN - PRESIDENT

NOTE: The Briggs & Stratton Engine Warranty does not cover breakage of parts or damage to parts due to abuse or failure to follow recommended regular maintenance of crankcase oil level, cleaning of air cleaner and engine cooling fins, nor does it warrant any accessories, controls or equipment not of our manufacture.

Engine Model No. \_\_\_\_\_  
 Engine Type No. \_\_\_\_\_  
 Engine Code No. \_\_\_\_\_  
 Date Purchased \_\_\_\_\_

} See Illustration on Page 1 to locate Model, Type and Code Number.

Dealer Purchased from \_\_\_\_\_  
 Type of Equipment \_\_\_\_\_  
 Name or Trademark of Equipment Manufacturer \_\_\_\_\_

**NO REGISTRATION (WARRANTY) CARD IS NECESSARY IN ORDER TO OBTAIN WARRANTY ON BRIGGS & STRATTON ENGINES**

In case warranty service is ever needed you should present the above information to the nearest Authorized Service Dealer. You will need to give a complete report on the trouble experienced and the number of hours the engine has run since the equipment was purchased.

If you differ with the decision of a Service Dealer on a warranty claim, the Dealer's terms should be accepted. The Dealer will submit all supporting facts to the factory for review. If the factory's decision is that your claim is justified, you will be fully reimbursed for those items accepted as defective.

For replacement parts or service, only the Model, Type and Code numbers are needed by the Authorized Service Dealer.

**NATION WIDE SERVICE ORGANIZATION**

Briggs & Stratton maintains a vast network of Authorized Service Dealers that are prepared to give you prompt and efficient engine service.

Each member of this organization carries a stock of original Briggs & Stratton repair parts and is equipped with special service tools. Trained mechanics assure expert repair service on all Briggs & Stratton engines.

See yellow pages of your Classified Telephone Directory for nearby engine service under heading -- "Engines Gasoline" or "Gasoline Engines".

